

**Informal Group on GTR9 Phase2  
(IG GTR9-PH2)  
1<sup>st</sup> Meeting**

**Technical Discussion – Injury Criteria**

December 1-2, 2011

Japan Automobile Standards Internationalization Center (JASIC)<sup>1</sup>

# Outline

1. Flex-TEG Discussion on Flex-PLI Injury Thresholds
2. Validation – Tibia Fracture Threshold
3. Validation – MCL Failure Threshold
4. Validation – ACL Failure Threshold
5. Summary

# 1. Flex-TEG Discussion on Flex-PLI Injury Thresholds

TEG-127

7 December 2009

## Technical Background Information Document for the UN-ECE GRSP explaining the Derivation of Threshold Values and Impactor Certification methods for the FlexPLI version GTR agreed by the FlexPLI-TEG at their 9<sup>th</sup> Meeting

Drafted by: Atsuhiko Konosu (JARI/J-MLIT) and Oliver Zander (BASt) on behalf of the GRSP FlexPLI Technical Evaluation Group (TEG)

### 1) Tibia Threshold Value: 340 Nm

At the 8<sup>th</sup> GRSP Flex-TEG meeting on May 19<sup>th</sup>, 2009, two proposals for the tibia threshold value of the FlexPLI version GTR (also called Flex-GTR) were made by JAMA and BASt, coming to different conclusions.

#### a) 380 Nm (JAMA)

JAMA derived the Flex-GTR tibia bending moment threshold using a linear transition equation between human and Flex-GTR Finite Element (FE) models derived from computer simulation results.

## Injury threshold discussion at Flex-TEG based on various studies by Flex-TEG members

# 1. Flex-TEG Discussion on Flex-PLI Injury Thresholds

- Proposed Thresholds -

TEG-127

Injury	Measure	Threshold	Note
Tibia Fracture	Max. Tibia Bending Moment	340 Nm 380 Nm	Relaxation Zone
MCL Failure	Max. MCL Elongation	22 mm	
ACL/PCL Failure	Max. ACL/PCL Elongation	13 mm	

**Common threshold values were reached and proposed by Flex-TEG**

# 2. Validation – Tibia Fracture Threshold

- EEVC WG17 Report -

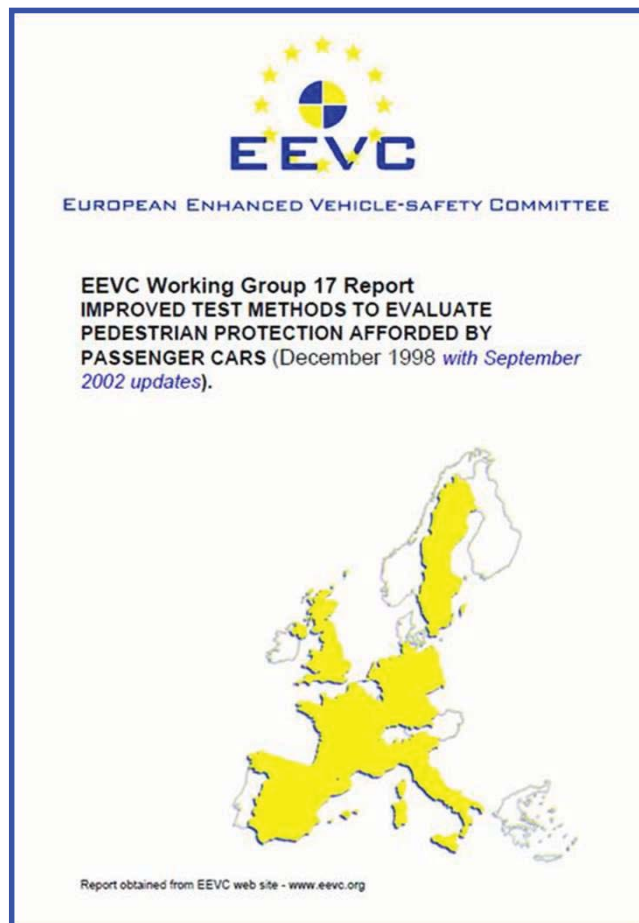

## Tibia Fracture Probability As a Function of Tibia Acceleration

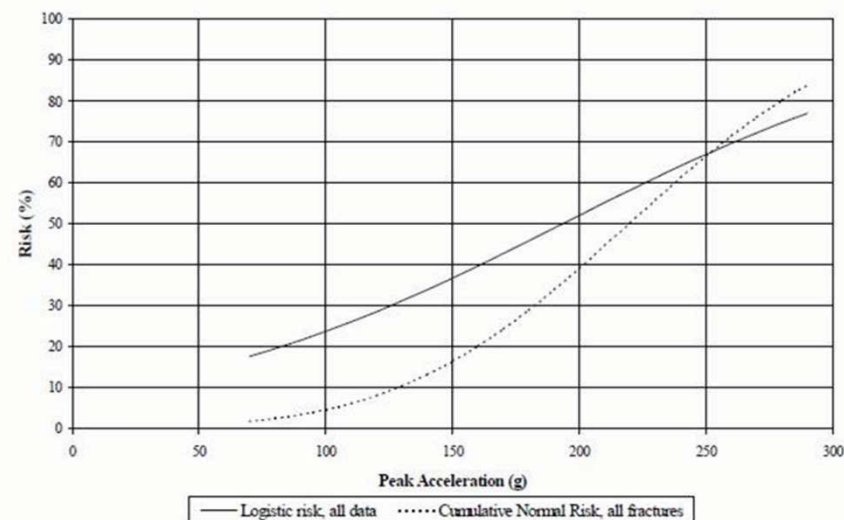

Figure 3. Comparison of AIS 2+ lower leg injury risk functions based on a logistic method and based on a cumulative normal method using 20 cadaver leg tests[32], obtained from [31].

**Re-analyze tibia fracture probability function for tibia acceleration**

## 2. Validation – Tibia Fracture Threshold

### - EEVC WG17 Report -

28. Ishikawa, H. et al.:

*A Study on Injury Criteria of EEVC Pedestrian Legform Test.*

JARI/JAMA, June 1998, EEVC WG17 document 85.

29. JAMA:

*JAMA proposal regarding the Criteria of Pedestrian Protection Test Procedure.*

June 1998, EEVC WG17 document 83.

30. Cesari, D.:

*Pedestrian Protection - synthesis of experimental and simulation researches performed in France.*

INRETS, August 1998, EEVC WG17 document 92.

31. Bunketorp, O. et al.:

*Experimental Study of a Compliant Bumper System.*

SAE paperno. 831623, 1983.

← Data Source

32. Rodmell, C. and G.J.L. Lawrence:

*Comparison between dose-response and cumulative methods of injury risk analysis and implications on the JARI injury risk analysis.*

TRL, November 1998, EEVC WG17 document 111.

33. Schreiber, P. et al.:

*Static and dynamic bending strength of the leg.*

Proceedings IRCOBI Conference, September 1997, EEVC WG17 document 61.

### Human data from Bunketorp et al. (1983)

# 2. Validation – Tibia Fracture Threshold

- Bunketorp et al., 1983 -

831623

## Experimental Study of a Compliant Bumper System

Olle Bunketorp, Bertil Romanus,  
and Tommy Hansson  
Dept. of Orthopaedic Surgery  
University of Göteborg

Bertil Aldman and Lennart Thorngren  
Dept. of Traffic Safety  
Chalmers University of Technology  
Göteborg

Rolf H. Eppinger  
NHTSA, U.S. Dept. of Transportation  
Washington, DC

### ABSTRACT

An ordinary rigid bumper system and a compliant bumper system are compared in an experimental study.

During the last years the annual number of pedestrian casualties constituted approximately 20% of the total number of injured road users /3/.

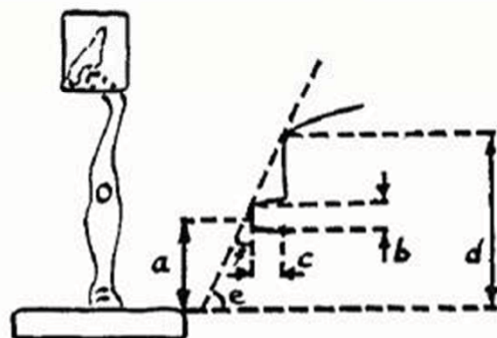

a=bumper level  
b=bumper width  
c=bumper lead distance

d=bonnet edge height  
e=bumper lead angle  
f=front inclination angle  
(= 90-e)

Figure 1 The experimental set up.

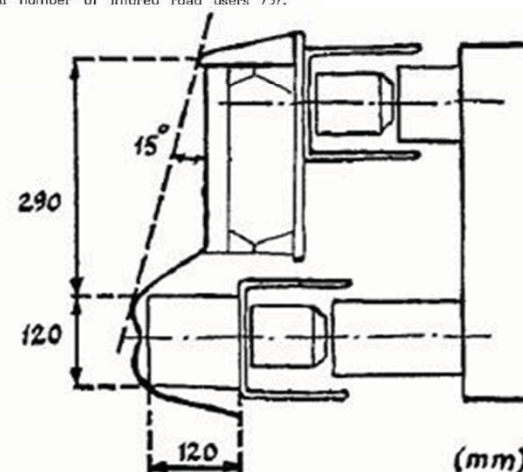

Figure 2 Section of the impact zone

## Isolated lower limbs impacted by high/low and rigid/compliant bumpers

Reference: Bunketorp O., Romanus B., Hansson T., Aldman B., Thorngren L. Eppinger R., Experimental Study of a Compliant Bumper System, 27<sup>th</sup> Stapp Car Crash Conference Proceedings, SAE Paper Number 831623 (1983)

## 2. Validation – Tibia Fracture Threshold

- Bunketorp et al., 1983 -

Front Configuration	Test No.	Age	Gender	Tibia Length (mm)	Peak Accel. (G)	Fem. Condyle Fx	Tib. Condyle Fx.	MCL Failure	ACL Failure	PCL Failure	Tib. Fx	Fib. Fx	Ankle Fx	Ankle Lig. Failure
High/Rigid	1	61	M	400	230	0	1	1	0	0	0	0	0	1
	2	80	M	350	260	0	0	1	1	0	0	0	0	0
	3	77	M	350	285	0	1	1	1	0	0	1	0	1
	4	81	F	360	295	0	0	1	1	1	0	0	0	0
	5	77	M	380	245	0	0	1	1	0	0	0	0	0
High/Compliant	6	71	M	390	95	0	1	0	0	0	1	1	0	0
	7	76	F	350	85	1	0	0	0	0	0	0	0	0
	8	65	M	370	70	0	0	1	0	1	0	0	0	0
	9	72	M	380	85	0	0	1	1	1	0	0	0	0
	10	54	M	420	100	0	0	1	0	0	0	0	0	0
Low/Rigid	11	73	F	380	225	0	1	0	1	1	0	1	1	1
	12	73	F	370	275	0	0	0	0	0	1	1	0	0
	13	75	M	350	200	0	1	0	0	0	0	1	0	0
	14	86	M	390	270	0	0	0	0	0	1	1	0	0
	15	-	-	370	280	0	0	0	0	0	0	1	0	0
Low/Compliant	16	74	F	350	70	0	0	1	0	0	0	0	0	0
	17	75	F	340	80	0	0	1	0	0	0	0	0	0
	18	83	F	350	115	0	0	1	0	0	0	1	1	0
	19	76	M	380	120	0	0	1	0	0	0	0	0	0
	20	69	M	400	80	0	0	1	0	0	0	0	0	0

Injury Data 0: No Injury, 1: Injury

- EVC probability functions used all the tibia/fibula fracture data regardless of the impact location relative to the fracture location
- Fracture data due to direct impact should be used to develop fracture probability function for upper tibia acceleration



## 2. Validation – Tibia Fracture Threshold

- Assumption -

- Bunketorp et al. provides Tibia Length
- Estimate Knee Height from the ground

The bone strength of the specimens was assessed from the bone mineral content (BMC), measured by dichromatic absorptiometry as in a previous test series /7/. Scans were made at the midpoint of the lower leg, the tibial condyle, and the midpoint of the femur. The sum of the BMC values at these three measuring points was considered related to the bone strength.

The specimens were standing in a shoe on a foot plate with a high friction. The impact level was varied by changing the height of this plate. The specimens were balanced with the knee extended and struck on their anterolateral aspect with the

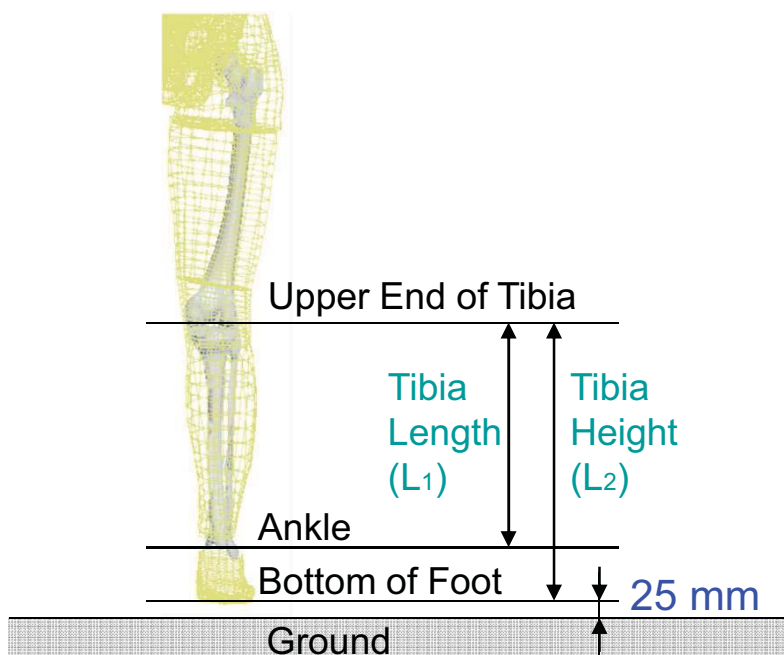

Leg specimens were wearing a shoe

Assume 25mm between the ground and the bottom of the foot

UMTRI Anthropometric Study :

L1 = 402 mm

L2 = 483 mm

Assume  $L2 / L1 = 1.2015$  (Ratio from UMTRI data) for all specimens

## 2. Validation – Tibia Fracture Threshold

Front Configuration	Test No.	Age	Gender	Tibia Length (mm)	Peak Accel. (G)	Tib. Condyle Fx.	Tib. Fx	Fib. Fx	Estimated Tibia Height (mm)	Estimated Ground-Knee (mm)	Bumper Height (mm)
High/Rigid	1	61	M	400	230	1	0	0	480.6	505.6	450
	2	80	M	350	260	0	0	0	420.5	445.5	450
	3	77	M	350	285	1	0	1	420.5	445.5	450
	4	81	F	360	295	0	0	0	432.5	457.5	450
	5	77	M	380	245	0	0	0	456.6	481.6	450
High/Compliant	6	71	M	390	95	1	1	1	468.6	493.6	450
	7	76	F	350	85	0	0	0	420.5	445.5	450
	8	65	M	370	70	0	0	0	444.6	469.6	450
	9	72	M	380	85	0	0	0	456.6	481.6	450
	10	54	M	420	100	0	0	0	504.6	529.6	450
Low/Rigid	11	73	F	380	225	1	0	1	456.6	481.6	325
	12	73	F	370	275	0	1	1	444.6	469.6	325
	13	75	M	350	200	1	0	1	420.5	445.5	325
	14	86	M	390	270	0	1	1	468.6	493.6	325
	15	-	-	370	280	0	0	1	444.6	469.6	325
Low/Compliant	16	74	F	350	70	0	0	0	420.5	445.5	325
	17	75	F	340	80	0	0	0	408.5	433.5	325
	18	83	F	350	115	0	0	1	420.5	445.5	325
	19	76	M	380	120	0	0	0	456.6	481.6	325
	20	69	M	400	80	0	0	0	480.6	505.6	325

Injury Data 0: No Injury, 1: Injury

**Investigate impact locations relative to the leg for each specimen with leg fractures using estimated knee height**

## 2. Validation – Tibia Fracture Threshold

- Specimens with Leg Fractures -

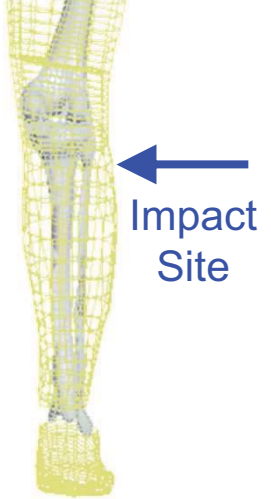
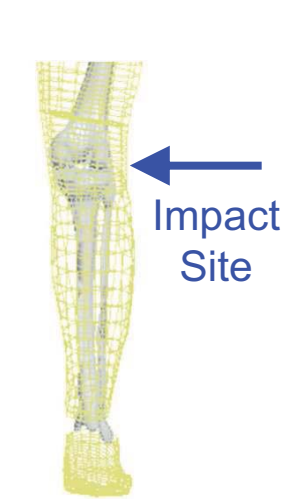
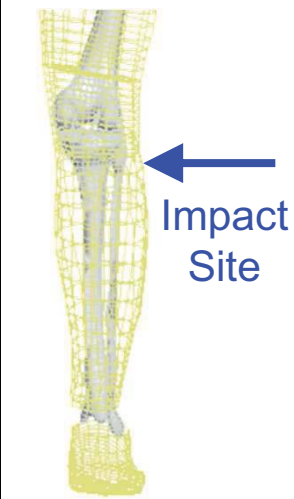
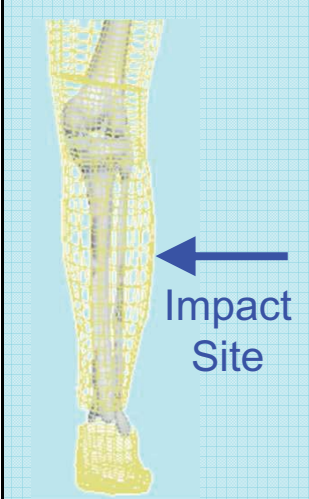
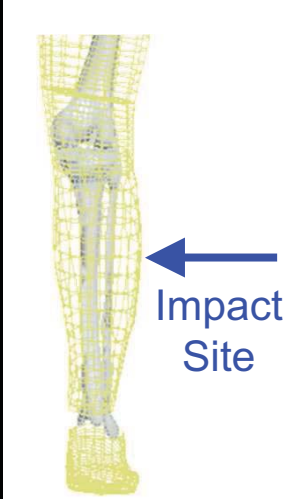
Test #	1	3	6	11	12
Schematics (Impact locations)					
Documented Leg Fractures	● Tibial Condyle	● Tibial Condyle ● Fibula	● Tibial Condyle ● Tibia (shaft) ● Fibula	● Tibial Condyle ● Fibula	● Tibia (shaft) ● Fibula
Direct / Indirect Estimation	Direct (Tibia)	Direct (Tibia and Fibula)	Direct (Tibia and Fibula) Indirect (Tibia)	Indirect (Tibia) Direct (Fibula)	Direct (Tibia and Fibula)

\*fracture locations possibly due to direct loading: in blue 11

## 2. Validation – Tibia Fracture Threshold

- Specimens with Leg Fractures -

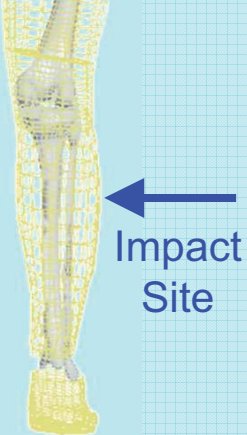
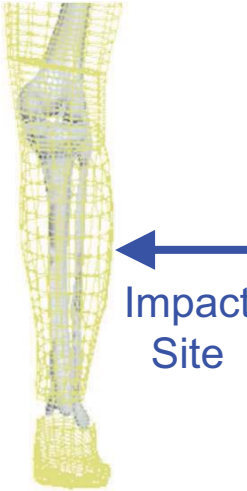
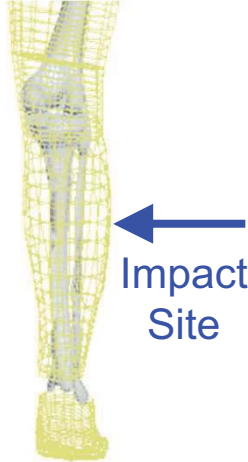
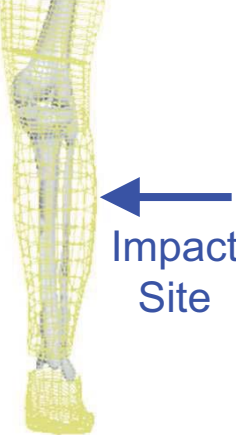
Test #	13	14	15	18
Schematics (Impact locations)				
Documented Leg Fractures	<ul style="list-style-type: none"> <li>● Tibial Condyle</li> <li>● Fibula</li> </ul>	<ul style="list-style-type: none"> <li>● Tibia (shaft)</li> <li>● Fibula</li> </ul>	<ul style="list-style-type: none"> <li>● Fibula</li> </ul>	<ul style="list-style-type: none"> <li>● Fibula</li> </ul>
Direct / Indirect Estimation	<ul style="list-style-type: none"> <li>Indirect (Tibia)</li> <li>Direct (Fibula)</li> </ul>	<ul style="list-style-type: none"> <li>Direct (Tibia and Fibula)</li> </ul>	<ul style="list-style-type: none"> <li>Direct (Fibula)</li> </ul>	<ul style="list-style-type: none"> <li>Direct (Fibula)</li> </ul>

\*fracture locations possibly due to direct loading: in blue 12

## 2. Validation – Tibia Fracture Threshold

- Development of Fracture Probability Function from Bunketorp et al. (1983) -

- Develop fracture probability function under the following conditions
  - Weibull Survival Model
  - Fracture data analyzed as “left censored” (no data provided as to the correlation between fracture and peak acceleration)
  - No fracture data analyzed as “right censored”
  - Acceleration data scaled to standard anthropometry (UMTRI data) using the standard tibia length (402 mm) : Scale factor for acceleration is  $1/\lambda_L$  (where  $\lambda_L$  is length scaling factor)
- Data classification (Injury / No injury)
  - Injury data : Test 1, 3, 6, 12, 14
  - No injury data : Test 2, 4, 5, 7, 8, 9, 10, 15, 16, 17, 18, 19, 20
  - Eliminate tests 11 and 13 (fracture due to indirect loading)

## 2. Validation – Tibia Fracture Threshold

- Development of Fracture Probability Function from Bunketorp et al. (1983) -

Front Configuration	Test No.	Age	Gender	Tibia Length (mm)	Peak Accel. (G)	Tib. Condyle Fx.	Tib. Fx	Fib. Fx	Peak Accel. (G)	UMTRI Tibia Length	UMTRI Length Scale Factor	UMTRI Scaled Accel. (G)	Classification
High/Rigid	1	61	M	400	230	1	0	0	230	402	1.0050	228.9	Injury
	2	80	M	350	260	0	0	0	260	402	1.1486	226.4	No Injury
	3	77	M	350	285	1	0	1	285	402	1.1486	248.1	Injury
	4	81	F	360	295	0	0	0	295	402	1.1167	264.2	No Injury
	5	77	M	380	245	0	0	0	245	402	1.0579	231.6	No Injury
High/Compliant	6	71	M	390	95	1	1	1	95	402	1.0308	92.2	Injury
	7	76	F	350	85	0	0	0	85	402	1.1486	74.0	No Injury
	8	65	M	370	70	0	0	0	70	402	1.0865	64.4	No Injury
	9	72	M	380	85	0	0	0	85	402	1.0579	80.3	No Injury
	10	54	M	420	100	0	0	0	100	402	0.9571	104.5	No Injury
Low/Rigid	11	73	F	380	225	1	0	1	225	402	1.0579	212.7	Not Used
	12	73	F	370	275	0	1	1	275	402	1.0865	253.1	Injury
	13	75	M	350	200	1	0	1	200	402	1.1486	174.1	Not Used
	14	86	M	390	270	0	1	1	270	402	1.0308	261.9	Injury
	15	-	-	370	280	0	0	1	280	402	1.0865	257.7	No Injury
Low/Compliant	16	74	F	350	70	0	0	0	70	402	1.1486	60.9	No Injury
	17	75	F	340	80	0	0	0	80	402	1.1824	67.7	No Injury
	18	83	F	350	115	0	0	1	115	402	1.1486	100.1	No Injury
	19	76	M	380	120	0	0	0	120	402	1.0579	113.4	No Injury
	20	69	M	400	80	0	0	0	80	402	1.0050	79.6	No Injury

Probability function for tibia fracture due to direct impact was developed using scaled peak acceleration data

## 2. Validation – Tibia Fracture Threshold

- Development of Fracture Probability Function from Bunketorp et al. (1983) -

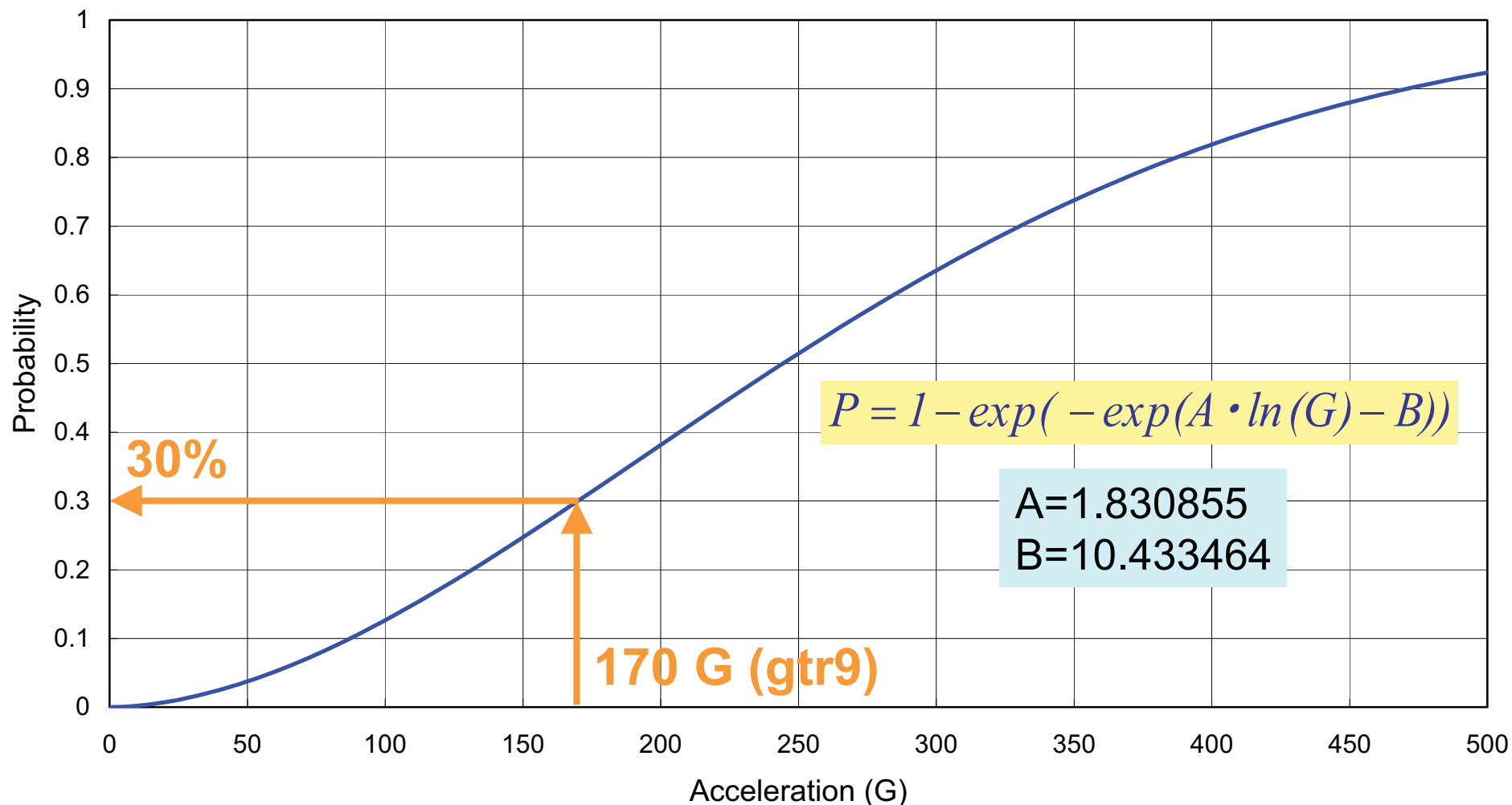

**Probability of tibia fracture due to direct loading at 170G is estimated as 30%**

# 2. Validation – Tibia Fracture Threshold

- Standard Anthropometry (UMTRI Study) -

TABLE 1.4

MID-SIZED MALE STANDARD ANTHROPOMETRY  
(Descriptive Statistics, cm or as noted)

Measurement Variable	N	Min.	Max.	Mean	S.D.
Age (years)	25	20.0	61.0	38.1	12.2
Stature	25	171.2	178.6	175.1	2.1
Weight (kg)	25	70.0	83.6	76.7	3.5
Sitting Height (erect)	25	87.2	95.0	91.1	2.3
Buttock-Knee Length	25	55.9	62.6	59.3	2.1
Cervicale Height	25	145.6	153.8	149.8	2.2
Trochanterion Height	25	84.0	95.7	90.5	2.3
Tibiale Height	25	45.0	51.8	48.3	1.9
Head Breadth	25	14.4	16.9	15.8	0.6
Head Length	25	18.8	21.4	19.7	0.7
Head Height	25	21.8	24.9	23.1	0.8
Shoulder Breadth	25	41.3	47.6	44.9	1.7
Biacromial Breadth	25	35.7	43.2	39.5	1.9
Clavicale Length	25	16.6	19.9	18.3	0.9
Suprasternale-Cerv. Dist.	25	11.6	13.8	12.6	0.6
Bispinous Breadth	25	18.7	27.7	22.5	1.9
Acromion-Radiale Length	25	30.8	35.1	32.9	1.2
Shoulder-Elbow Length	25	32.6	38.5	36.5	1.3
Elbow-Hand Length	25	44.5	49.7	47.4	1.3
Radius Length	25	24.8	29.1	26.9	1.1
Hand Breadth	25	7.6	10.2	8.5	0.6
Hand Length	25	17.6	19.5	18.7	0.5
Troch.-to-Lat. Fem. Condyle	25	38.4	46.2	43.5	2.0
Tibia Length	25	36.2	44.3	40.2	2.2
Foot Breadth	25	8.4	10.8	9.6	0.5
Foot Length	25	24.6	27.8	26.4	0.8
Head Circumference	25	53.3	60.9	57.1	1.9
Shoulder Circumference	25	102.3	120.0	111.5	5.3
Chest Circumference (axilla)	25	91.0	104.5	97.3	3.2
Chest Circumference (nipple)	25	89.3	102.5	96.1	3.6
Waist Circumference	25	77.2	94.7	85.9	5.2
Hip Circumference	25	87.3	101.5	94.4	3.1
Upper Arm Circumference (biceps)	25	24.6	35.0	29.9	2.0
Forearm Circumference	25	21.8	28.6	25.4	1.7
Thigh Circumference (mid)	25	45.7	57.3	51.5	3.2
Calf Circumference	25	33.8	39.8	36.7	1.7
Skinfold, Subscapular (mm)	25	10.0	30.0	15.1	4.5
Skinfold, Triceps (mm)	25	4.0	25.0	10.0	6.2
Skinfold, Suprailiac (mm)	25	7.0	37.0	21.1	8.0
Skinfold, Posterior Mid-Calf (mm)	25	3.0	20.0	9.9	5.1

Measurement Variable	N	Min.	Max.	Mean	S.D.
Trochanterion Height	25	84.0	95.7	90.5	2.3
Tibiale Height	25	45.0	51.8	48.3	1.9
Head Breadth	25	14.4	16.9	15.8	0.6

Mean



Measurement Variable	N	Min.	Max.	Mean	S.D.
Troch.-to-Lat. Fem. Condyle	25	38.4	46.2	43.5	2.0
Tibia Length	25	36.2	44.3	40.2	2.2
Foot Breadth	25	8.4	10.8	9.6	0.5

Mean



To develop probability function for tibia fracture due to bending, bending moment data were scaled using UMTRI study, based on which impactor dimensions were determined



## 2. Validation – Tibia Fracture Threshold

- Development of Tibia Fracture Probability Function due to Bending -

Test	Source	Age	Gender	Stature (mm)	Weight (kg)	Anatomical Measurement (mm)	Anatomical Measurement Description	Fracture Moment (Nm)	UMTRI STD Anatomical Measurement (mm)	UMTRI Length Scale Factor	UMTRI Scaled Fracture Moment (Nm)	Data Censoring
9.1	Kerrigan 2004	66	M	1829	79.8	397	Tibia Length	277	402	1.0126	287.6	Uncensored
9.2	Kerrigan 2004	69	M	1702	81.6	418	Tibia Length	433	402	0.9617	385.2	Uncensored
9.3	Kerrigan 2004	62	M	1829	60.8	416	Tibia Length	259	402	0.9663	233.7	Uncensored
9.4	Kerrigan 2004	54	M	1880	117.9	479	Tibia Length	482	402	0.8392	284.9	Uncensored
N-126	Nyquist 1985	58	M	1740	73	480	Tibia Height	224	483	1.006	228.2	Right Censored
N-129	Nyquist 1985	57	M	1780	99	500	Tibia Height	349	483	0.966	314.6	Right Censored
N-147	Nyquist 1985	57	M	1780	84	405	Tibia Height	431	483	1.193	731.1	Right Censored
N-127	Nyquist 1985	56	M	1760	79	465	Tibia Height	237	483	1.039	265.6	Right Censored
N-124	Nyquist 1985	64	M	1770	82	490	Tibia Height	287	483	0.986	274.9	Right Censored
N-118	Nyquist 1985	54	M	1820	68	520	Tibia Height	395	483	0.929	316.5	Right Censored
N-132	Nyquist 1985	57	M	1870	45	445	Tibia Height	264	483	1.085	337.6	Right Censored
N-148	Nyquist 1985	57	F	1630	75	420	Tibia Height	254	483	1.150	386.3	Right Censored
N-152	Nyquist 1985	51	F	1630	68	430	Tibia Height	274	483	1.123	388.3	Right Censored
K(a)-134L	Kerrigan SAE 2003	44	M	1702	73	420	Tibia Length	416	402	0.9571	364.8	Uncensored
K(b)-D1	Kerrigan NCCM 2003	54	M	1905	88	445	Tibia Length	463	402	0.9034	341.3	Uncensored
K(b)-D2	Kerrigan NCCM 2003	54	M	1905	88	450	Tibia Length	485	402	0.8933	345.8	Uncensored
K(b)-D3	Kerrigan NCCM 2003	68	M	1651	51	385	Tibia Length	290	402	1.0442	330.1	Uncensored
K(b)-D4	Kerrigan NCCM 2003	68	M	1651	51	385	Tibia Length	309	402	1.0442	351.8	Uncensored
K(b)-D5	Kerrigan NCCM 2003	65	F	1727	60	378	Tibia Length	416	402	1.0635	500.4	Uncensored
K(b)-D6	Kerrigan NCCM 2003	75	M	1778	65	395	Tibia Length	306	402	1.0177	322.6	Uncensored

- Tibia bending moment data sources : Kerrigan et al. (2003, 2003, 2004), Nyquist et al. (4 papers)
- One data from Nyquist et al. was omitted as an outlier

### References:

- Kerrigan et al., Tolerance of the Human Leg and Thigh in Dynamic Latero-Medial Bending, ICRASH (2004)
- Kerrigan et al., Experiments for establishing pedestrian-impact lower limb injury criteria, SAE Paper #2003-01-0895 (2003)
- Kerrigan et al., Response Corridors for the Human Leg in 3-Point Lateral Bending, 7th US National Congress on Computational Mechanics (2003)
- Nyquist et al., Tibia Bending: Strength and Response, SAE Paper #851728 (1985)

## 2. Validation – Tibia Fracture Threshold

- Tibia Fracture Probability Function due to Bending -

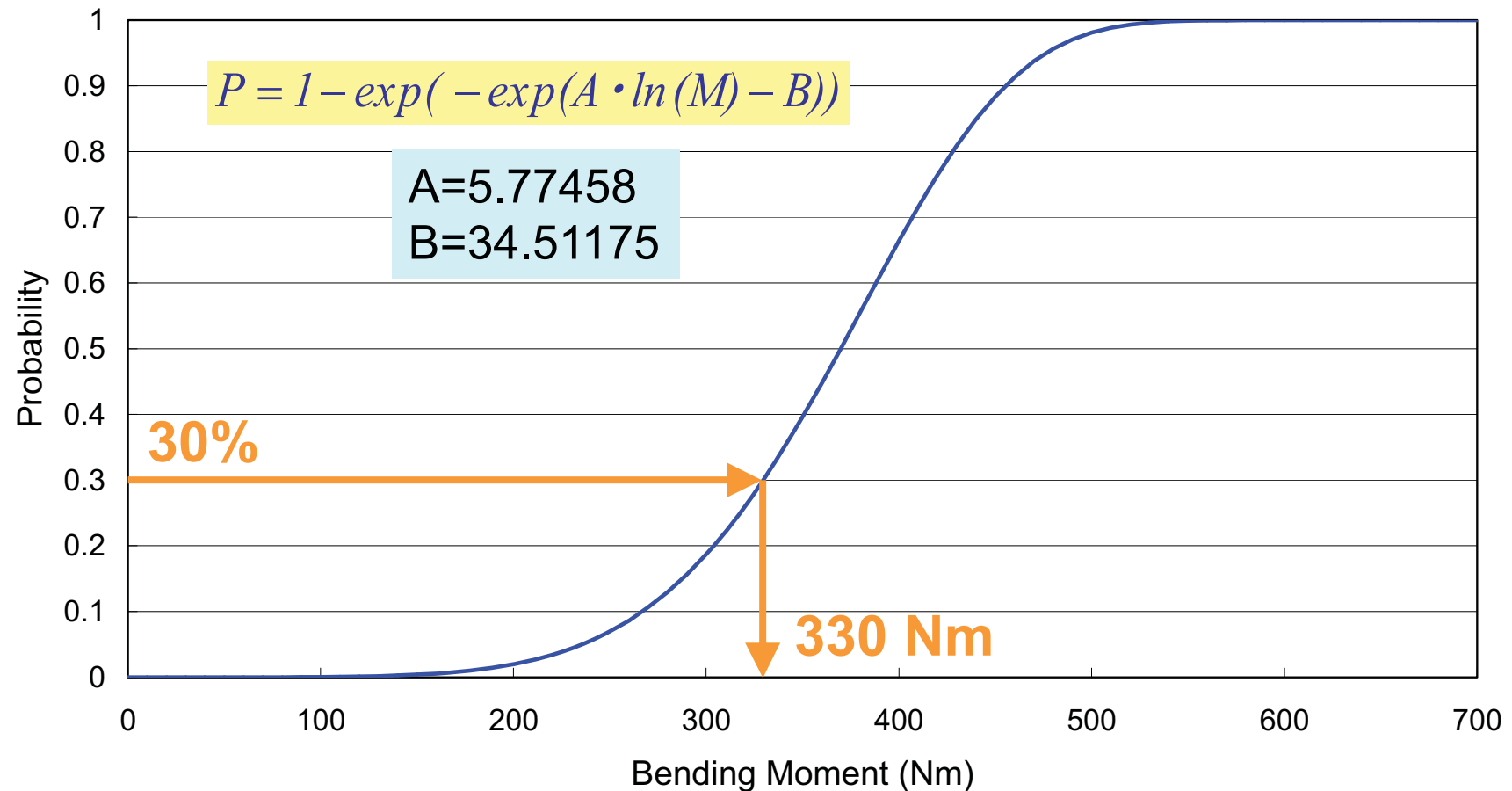

**Human tibia bending moment @ 30% probability  
of fracture is estimated as 330 Nm**

## 2. Validation – Tibia Fracture Threshold

- Human – Flex-PLI Correlation for Tibia Bending Moment -

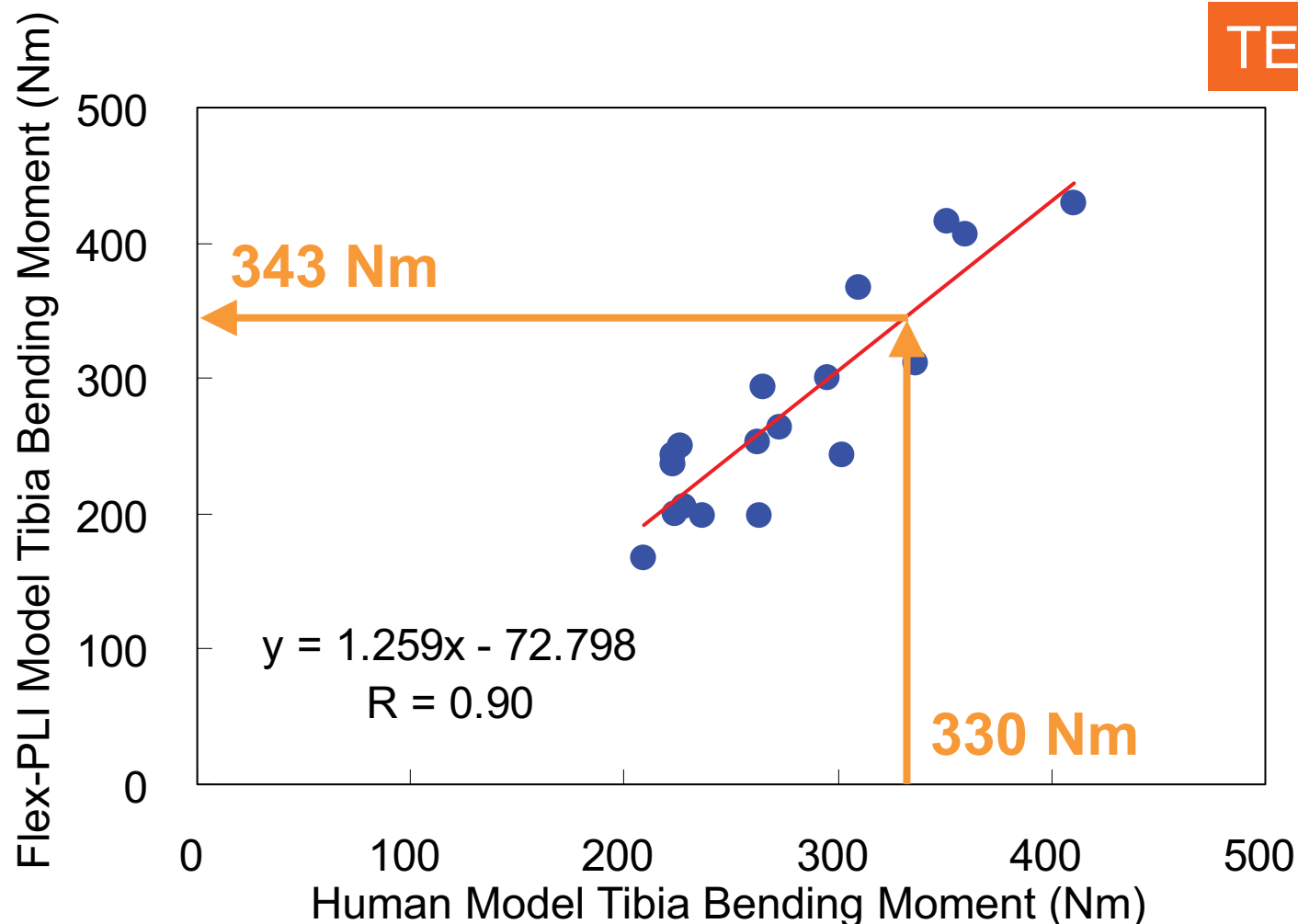

Flex-PLI tibia bending moment corresponding to **330 Nm** of human tibia bending moment is estimated as **343 Nm**

### 3. Validation – MCL Failure Threshold

- CAE Correlation Study -

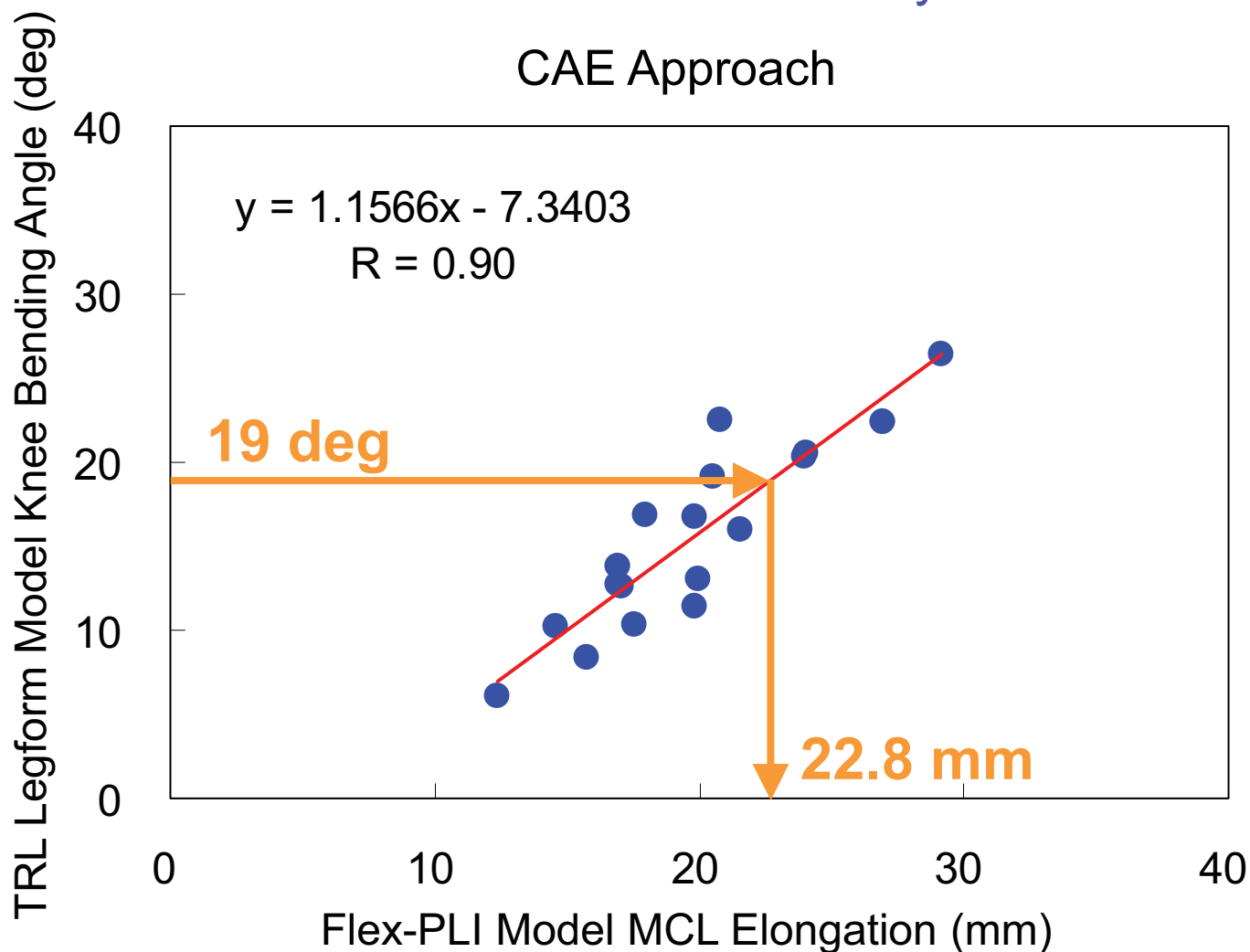

**Flex-PLI threshold is more conservative than TRL legform threshold by 3.5 %**

# 3. Validation – ACL Failure Threshold

- Bhalla et al. (2003) -

## Dynamic Shear Tests of Isolated Knee Joints

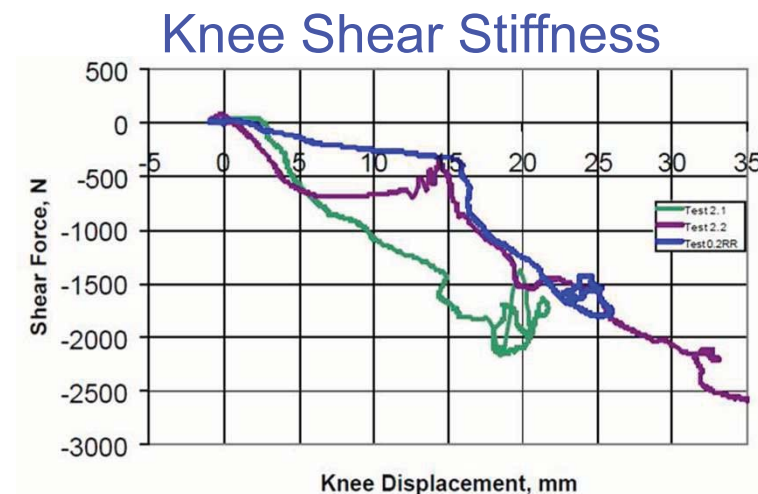
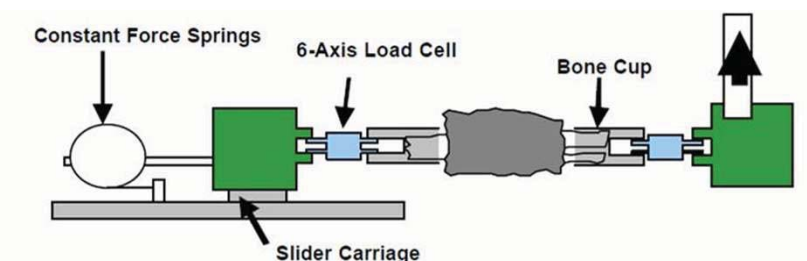

Since tibial-spine gouging/plowing is likely an ongoing process, a drop in forces is likely due to ACL damage. Thus, it is hypothesized that the early peak in shear forces (at **12.7 mm** of shear displacement, 693N shear force) in Test 2.2 is due to ACL failure. Similarly, ACL failure in Test 2.1 occurs at a shear force of 1839N and a shear displacement of **17.8 mm**.

**13 mm knee shear displacement would be a conservative failure threshold for ACL**

# 3. Validation – ACL Failure Threshold

- Flex-PLI Knee Joint Model -

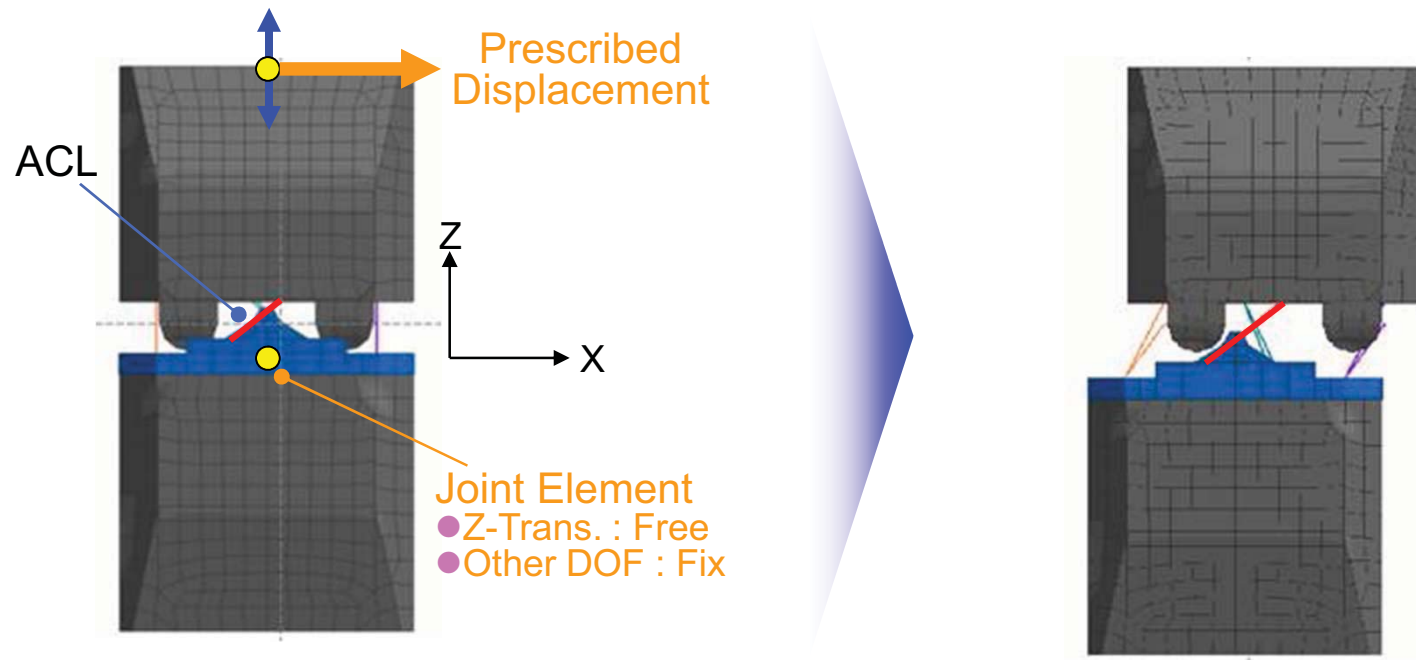

**Flex-PLI model was subjected to prescribed shear displacement to clarify relationship between knee shear displacement and ACL elongation**

# 3. Validation – ACL Failure Threshold

- Flex-PLI Knee Joint Model -

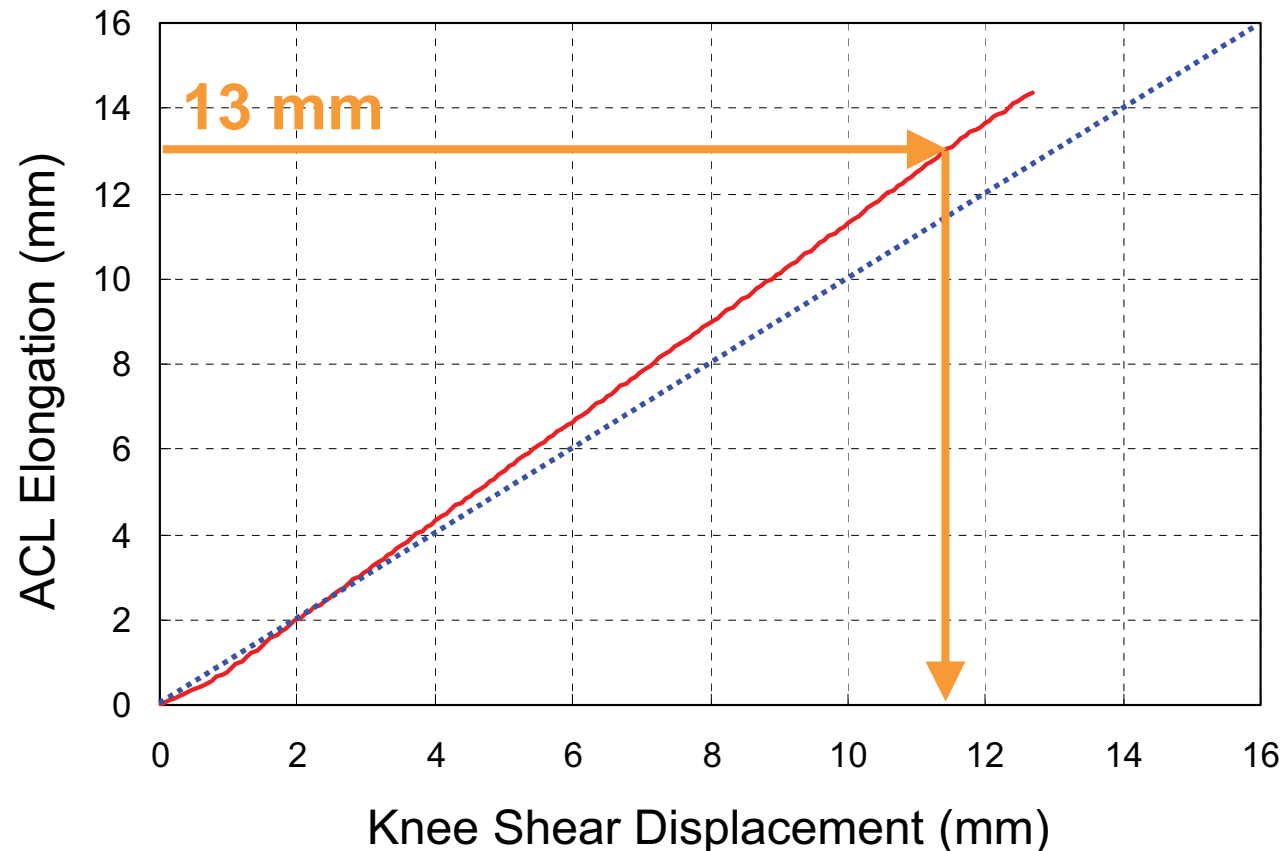

- ACL elongation nearly equals to knee shear displacement
- 13 mm ACL elongation corresponds to knee shear displacement smaller than 13 mm

## 4. Summary

- Injury thresholds proposed for Flex-PLI by Flex-TEG were determined based on different studies performed by different participants
- Tibia bending moment threshold proposed for Flex-PLI was estimated to be very similar to upper tibia acceleration threshold for TRL legform in terms of fracture probability
- MCL failure threshold proposed for Flex-PLI was estimated to be more conservative (by 3.5 %) than knee bending angle threshold for TRL legform in terms of fracture probability
- ACL failure threshold proposed for Flex-PLI corresponds to knee shear displacement smaller than 13 mm, which is the smaller value of the two data from Bhalla et al.



# References

- European Enhanced Vehicle-safety Committee, *EEVC Working Group 17 Report, IMPROVED TEST METHODS TO EVALUATE PEDESTRIAN PROTECTION AFFORDED BY PASSENGER CARS* (1998)
- Development of Anthropometrically Based Design Specifications for an Advanced Adult Anthropomorphic Dummy Family, Volume 1, UMTRI Report UMTRI-83-53-1 (1983)
- Bunketorp, O., Romanus, B., Hansson, T., Aldman, B., Thorngren, L., Eppinger, R., *Experimental Study of a Compliant Bumper System*, SAE Paper Number 831623 (1983)
- Kerrigan, J., Bhalla, K., Madeley, N., Funk, J., Bose, D., Crandall, J., Experiments for Establishing Pedestrian-Impact Lower Limb Injury Criteria, SAE Paper Number 2003-01-0895 (2003a)
- Kerrigan, J., Bhalla, K., Madeley, N., Crandall, J., Deng, B., *Response Corridors for the Human Leg in 3-Point Lateral Bending*, 7<sup>th</sup> US National Congress on Computational Mechanics (2003b)
- Kerrigan, J., Drinkwater, D., Kam, C., Murphy, D., Ivarsson, B., Crandall, J., Patrie, J., *Tolerance of the Human Leg and Thigh in Dynamic Latero-Medial Bending*, ICRASH (2004)

# References

- Nyquist, G., Cheng, R., El-Bohy, A., King, A., *Tibia Bending: Strength and Response*, SAE Paper Number 851728 (1985)
- Bhalla, K., Bose, D., Madeley, N., Kerrigan, J., Crandall, J., Longhitano, D., Takahashi, Y., *Evaluation of the Response of Mechanical Pedestrian Knee Joint Impactors in Bending and Shear Loading*, 18th ESV Conference, Paper Number 429 (2003)

***Thank you for your attention***