



GRSP UNECE R14 Workshop

GRSP UNECE R14 Workshop on Extended Use
Positions

27.05.2024 | B. Lorenz | BAST

GRSP UNECE R14 Workshop

- ▶ **Two-day workshop to discuss OICA's proposal for extending UNECE regulation No. 14 at BAST** (25.-26.04.2024) (Meeting Minutes → WSR14_7)
- ▶ **Presentations by experts** on the state of the art:
 - ▶ **Usability of ATDs in Extended Use Positions** (WSR14_3 – Dr. Hanna Paul, OICA/Mercedes-Benz)
 - ▶ **Current Dummies were developed for upright seating positions**
 - ▶ Hybrid III frontal impact dummies can be positioned up to an opening angle of 110° - THOR-50M can be positioned up to an opening angle of 120°
 - ▶ **Status of the ENOP Project** (WSR14_5 – D Dr. Andre Eggers, D/BAST)
 - ▶ **PMHS tests series to collect biomechanical reference data and to develop new injury risks curves for non-traditional seating positions**
 - ▶ Evaluation of different ATDs and HBMs in five different ENOP configurations
 - ▶ **OSCCAR** (WSR14_6 – Dr. Andre Eggers, D/BAST)
 - ▶ Type-approval of new seating positions by virtual testing methods with HBMs
 - ▶ **At the moment, HBMs were not validated to be used in new seating positions**

GRSP UNECE R14 Workshop

- ▶ Presentations by experts on the state of the art:
 - ▶ **Relation of the topic to the TF Virtual Testing in the EqOP IWG** (WSR14_4 – Dr. Corina Klug, A/TU Graz)
 - ▶ Possible link to EqOP TF3 on Virtual Crash-Testing and TF4 on Restraint System Requirements
 - ▶ The introduction of HBMs into regulations will potentially benefit occupant safety, but there is no qualification requirement yet.
 - ▶ **Status of the Validation of HBM for Extended Use Positions** (WSR14_4 – Dr. Corina Klug, A/TU Graz)
 - ▶ Literature review: Good correlation between HBM and PMHS in extended use positions. Some limitations w.r.t. pelvis rotation and lumbar spine loads.
 - ▶ So far, **no clear mechanism for submarining and higher lumbar spine loads identified.**
 - ▶ **New injury mechanisms might not be addressed in HBMs** so far and new validation on component level is probably required.
- ▶ **Discussion of OICA's proposal (WSR14_8) in a vehicle seat with different configurations and different dummies**

OICA Proposal for R14 Extension

- ▶ Permitted area is redefined for extended use positions (WSR14_8):
 - ▶ Upper anchorage point rotates with the backrest
 - ▶ Lower anchorage points are dependent on the change in the seat cushion and backrest inclination

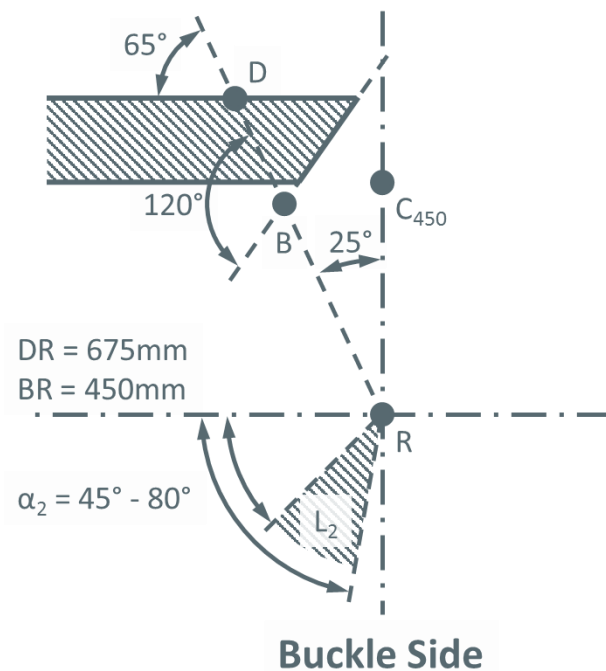
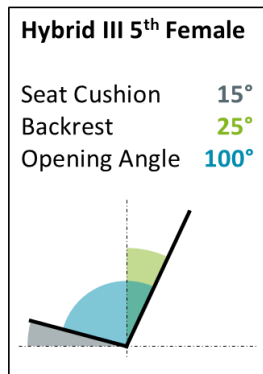

R14 Extension

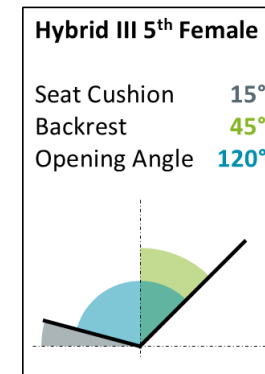
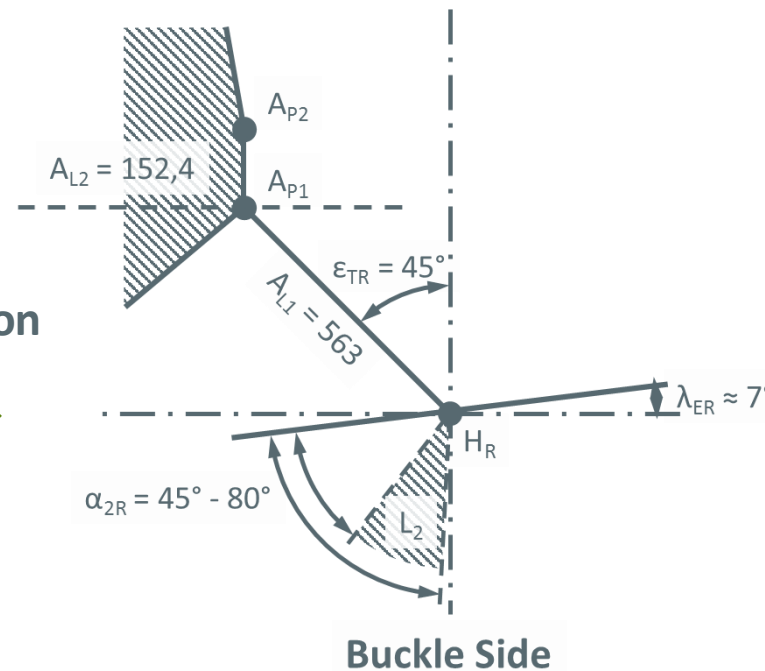

Workshop: OICA Proposal for R14 Extension

- ▶ Discussion of OICA's proposal (WSR14_8) in a vehicle seat with different configurations and different dummies:
 - ▶ No continuous contact between back and backrest for the Hybrid III family for 120° opening angle
 - ▶ Proposal to extend the R14 was positively received
 - ▶ Proposed area probably too high for an optimal belt routing for small occupants
 - ▶ The proposal allows L1 and L2 to be located in front of the H-point

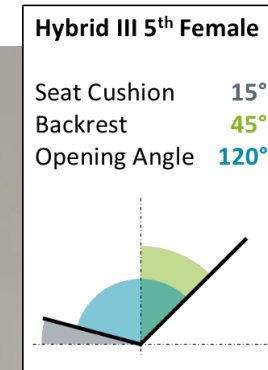
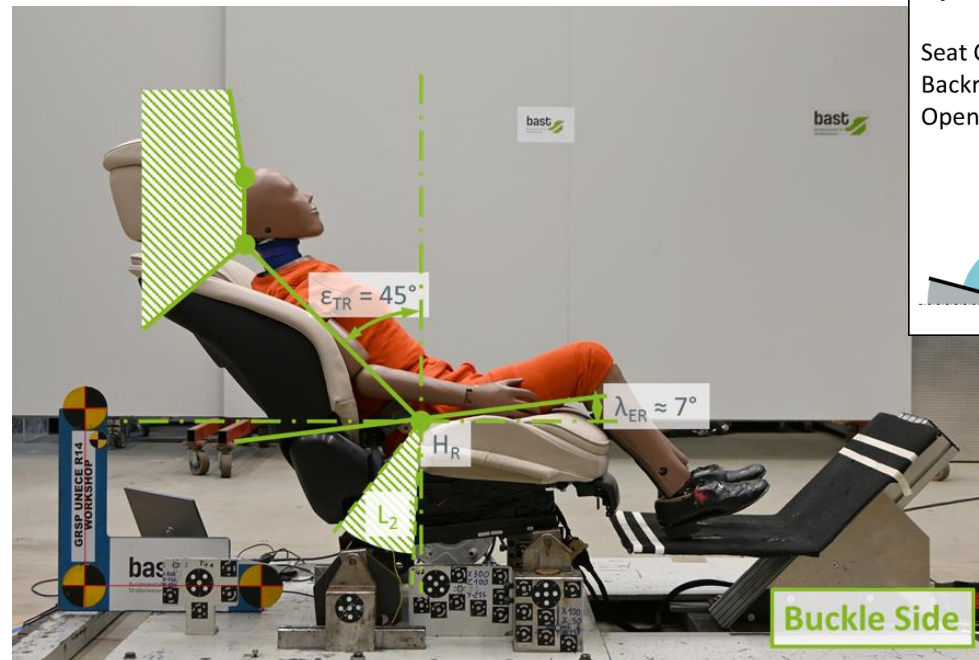
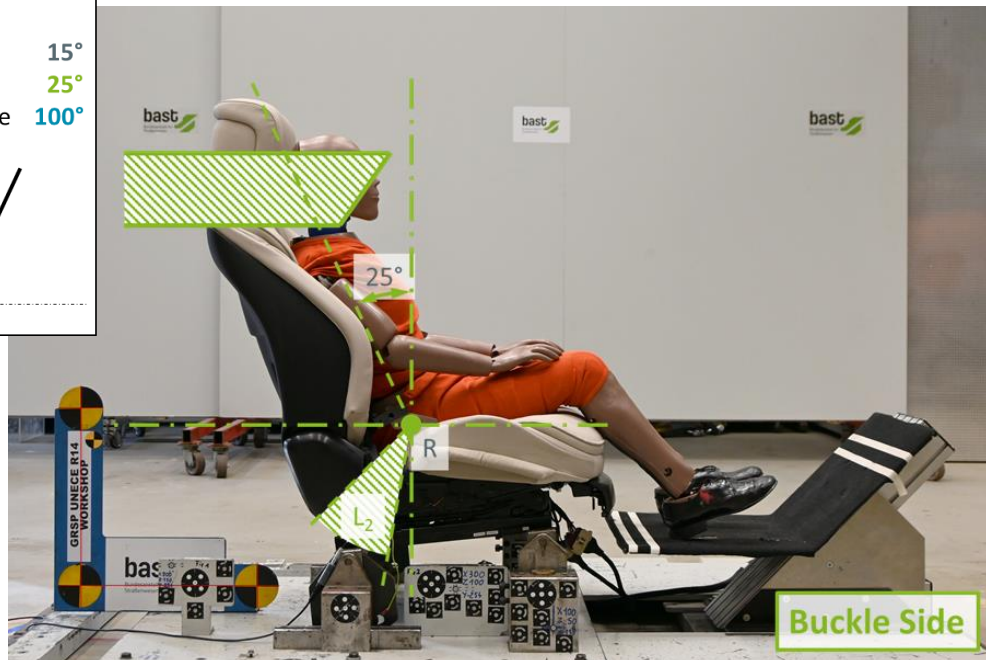
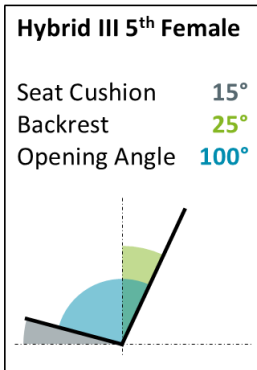

GRSP UNECE R14 Workshop @BAST



25 Participants

(2 virtual)

CPs: Austria, Germany,
Netherlands, Sweden

OICA and CLEPA

ATDs used:

Hybrid III 5%, Hybrid III 50%,
Hybrid III 95%, THOR 50%,
THOR 50% RS

Conclusion

- ▶ OICA's proposal (WSR14_8) to extend the R14 was positively received. Some adjustments remain to be discussed:
 - ▶ Proposed area might be too high for an optimal belt routing for small occupants
→ reduce A_{L_1} ?
 - ▶ The proposal allows L_1 and L_2 to be located in front of the H-point
→ some clarification needed (' L_1 and L_2 are not permitted to be in front of the H-point')
- ▶ No continuous contact between back and backrest for the Hybrid III family for 120° opening angle
- ▶ **Discussion on the definition of “care points” and how a link between UNECE Regulation No. 14 and other regulations (p. ex. R94, R95, R135, R137) can be established**

GRSP UNECE R14 Workshop

- ▶ All documents from the workshop can be found on the UNECE Wiki page:
<https://wiki.unece.org/pages/viewpage.action?pageId=246284335>
- ▶ Documentation for all ATDs in six different configurations is now also available on the Wiki page:
 - ▶ **WSR14_9**

Thank you!

**I look forward to the joint
discussion.**

Bernd Lorenz

Head of Section F2 – Passive Vehicle Safety, Biomechanics

 (+49) 2204 43-5200

 lorenz@bast.de