



NOT MEASUREMENT
SENSITIVE

DOE-HDBK-1092-2013
July 2013
Superseding
DOE-HDBK-1092-2004
December 2004

DOE HANDBOOK

ELECTRICAL SAFETY



U.S. Department of Energy
Washington, D.C.20585

AREA SAFT

DISTRIBUTION STATEMENT A. Approved for public release; distribution is unlimited.

Available on the Department of Energy
Technical Standards Program
Web site at
<http://www.hss.doe.gov/nuclearsafety/techstds/>

FOREWORD

1. This Department of Energy (DOE) Handbook is approved for use by the Office of Health, Safety and Security and is available to all DOE components and their contractors.
2. Specific comments (recommendations, additions, deletions, and any pertinent data) to enhance this document should be sent to:

Patrick Tran
HS-12/Germantown
U.S. Department of Energy
1000 Independence Ave. SW
Washington, DC 20585-0270

3. This DOE Electrical Safety Handbook replaces the DOE Electrical Safety Handbook that was originally issued in 1998, and revised in 2004. DOE handbooks are part of the DOE directives system and are issued to provide supplemental information regarding the Department's expectations for fulfilling its requirements as contained in rules, orders, notices, and regulatory standards. The handbooks may also provide acceptable methods for implementing those requirements. Handbooks are not substitutes for requirements, nor do they replace technical standards that are used to describe established practices and procedures for implementing requirements.
4. This updated handbook contains DOE-developed explanatory material in support of national electrical safety codes and standards, including those referenced in the Code of Federal Regulations (CFR) in 10 CFR 851, *Worker Safety and Health Program*. Sections of this handbook were revised and relocated within the handbook for improved clarity of information. This document references the most recent version of each code and standard at the time of development, recognizing that newer versions are invariably improved and provide increased safety over previous versions. 10 CFR 851 references the 2005 edition of the National Fire Protection Association (NFPA) 70, the National Electrical Code (NEC), and the 2004 edition of the *Standard for Electrical Safety in the Workplace* (NFPA 70E). This document, however, references the 2008 NEC and the 2009 NFPA 70E versions. Each site must ensure, through review, that its implementation of the newer versions meets the intent of 10 CFR 851. In addition other electrical codes and standards utilized in this handbook include: 29 CFR 1910, Subpart S, *Occupational Safety and Health Standards, Electrical*; 29 CFR 1926 Subpart K, *Safety and Health Regulations for Construction, Electrical*; IEEE/ANSI Std C2, *National Electrical Safety Code* (2007); NFPA 70B, *Recommended Practice for Electrical Equipment Maintenance* (2010); and others. For a complete list of references used in this document, see Section 14.

CONTENTS

1.0 INTRODUCTION	1
1.1 PURPOSE.....	1
1.2 SCOPE.....	1
1.3 ELECTRICAL SAFETY PROGRAM	2
1.4 AUTHORITY HAVING JURISDICTION	2
2.0 GENERAL REQUIREMENTS	4
2.1 ELECTRICAL MAINTENANCE OR REPAIRS	4
2.1.1 Work on Electrical Equipment.....	4
2.1.2 Considerations for Working on Energized Systems and Equipment.....	4
2.1.3 Safety Watch Responsibilities and Qualifications	5
2.2 BASIC SAFEGUARDS.....	5
2.3 RESPONSIBILITIES	6
2.3.1 Management Responsibilities	6
2.3.2 Employee Responsibilities	7
2.4 MODIFICATIONS TO FACILITIES	7
2.5 APPROVAL OF ELECTRICAL EQUIPMENT	7
2.6 CODES, STANDARDS, AND REGULATIONS.....	7
2.7 TRAINING AND QUALIFICATIONS OF QUALIFIED WORKERS	8
2.7.1 Formal Training and Qualifications	8
2.7.2 Training of Safety Personnel.....	9
2.8 WORKING SPACE AROUND ELECTRICAL EQUIPMENT	9
2.8.1 Electrical Equipment Rated at 600 Volts or Less.....	9
2.8.2 Electrical Equipment Rated over 600 Volts	11
2.9 IDENTIFICATION OF DISCONNECTING MEANS	12
2.9.1 Disconnecting Means.....	12
2.9.2 Panelboard Circuit Directories	12
2.9.3 Enclosure Labeling.....	12
2.9.4 Load Labeling.....	12
2.9.5 Source Labeling	12
2.10 WORK INSTRUCTIONS.....	13
2.10.1 Safe Work Instructions and Supervision	13
2.10.2 Work Planning.....	13
2.11 ELECTRICAL PERSONAL PROTECTIVE EQUIPMENT	14
2.11.1 Management's Responsibilities.....	14
2.11.2 Inspecting PPE.....	14
2.11.3 Cleaning and Electrical Testing of PPE	14
2.11.4 Live-Line Tools.....	15
2.11.5 Fiberglass-Handled Tools	15
2.11.6 Maximum-Use Alternating Current (AC) Voltage.....	15
2.11.7 Maximum Usage Voltage for Live-Line Tools	15
2.11.8 Rubber-Insulated Gloves	16
2.11.9 Storage.....	16
2.11.10 Safety Shoes, Hardhats, and Glasses.....	16

2.12	WORK PRACTICES	16
2.12.1	Establishing an Electrically-Safe Work Condition	16
2.12.2	Training	19
2.12.3	Planning the Work.....	19
2.12.4	Personal Protective Equipment.....	23
2.12.5	Electrical Injuries	23
3.0	Hazard Analysis	24
4.0	ELECTRICAL PREVENTIVE MAINTENANCE	25
4.1	DEVELOPMENT AND IMPLEMENTATION REQUIREMENTS	25
4.2	ELECTRICAL PREVENTIVE MAINTENANCE PROGRAM	25
4.3	MAINTENANCE	25
4.4	INSPECTION	25
4.5	ESSENTIAL ELEMENTS	26
4.6	PLANNING AND DEVELOPING AN EPM PROGRAM, AND FUNDAMENTALS OF EPM	26
4.7	GROUND FAULT PROTECTION AND ARC FAULT CIRCUIT INTERRUPTERS	26
4.7.1	Ground Fault Circuit Interrupters (GFCIs).....	27
4.7.2	Arc Fault Circuit Interrupters (AFCIs).....	28
4.7.3	Ground Fault Protection for Equipment (GFPE)	29
4.8	OVERCURRENT PROTECTIVE DEVICES	29
5.0	GROUNDING	30
5.1	SPECIFICATIONS AND DRAWINGS.....	30
5.2	CIRCUIT AND SYSTEM GROUNDING.....	30
5.3	EQUIPMENT GROUNDING	30
5.4	BONDING	31
5.5	GROUNDING OR UNGROUNDED SYSTEMS	32
5.5.1	Grounded Systems	33
5.5.2	Ungrounded Systems	34
5.5.3	High-Impedance Grounding.....	35
5.6	GROUNDING REQUIREMENTS.....	36
5.7	GROUNDING ELECTRODE CONDUCTOR (GEC).....	37
5.7.1	Sizing the Grounding Electrode Conductor	38
5.7.2	Exceptions to NEC 250.66.....	38
5.8	MAIN BONDING JUMPER.....	38
5.9	SYSTEM WITH GROUNDED CONDUCTOR.....	39
5.10	EQUIPMENT GROUNDING CONDUCTOR.....	40
5.10.1	Sizing the Equipment Grounding Conductor	41
5.10.2	Separate Equipment Grounding Conductors.....	41
5.11	UNGROUNDING SYSTEMS.....	41
5.12	GROUNDING A SEPARATELY DERIVED SYSTEM.....	42
5.13	GROUNDING ELECTRODE SYSTEM.....	42
5.14	PERSONNEL PROTECTIVE GROUNDS	43
5.14.1	Purpose of Personnel Protective Grounds	44
5.14.2	Criteria for Personnel Protective Grounds	44
5.14.3	Grounding Clamps	45

5.14.4	Screw-Tightening Devices	45
5.14.5	Grounding Cable Length	45
5.14.6	Grounding Cable Connection.....	45
5.14.7	Connecting Grounding Cables in Sequence.....	45
5.14.8	Removing Protective Grounds	45
5.14.9	Protective Apparel and Equipment	45
6.0	SPECIAL OCCUPANCIES	47
6.1	EXPLOSIVES.....	47
6.1.1	Evacuation	47
6.1.2	Shutdown of Operations	47
6.1.3	Lightning Protection	47
6.1.4	Static Electricity.....	48
6.1.5	Electrical Equipment and Wiring	51
6.1.6	Testing	53
6.2	PREVENTION OF EXTERNAL IGNITION AND EXPLOSION.....	57
6.2.1	Sources of Ignition	58
6.2.2	Combustion Principles	58
6.2.3	Evaluation of Hazardous Areas	59
6.2.4	Intrinsically Safe Equipment.....	59
6.2.5	Enclosures	59
6.2.6	Purging/Pressurization Systems	61
6.3	HAZARDOUS LOCATIONS.....	62
6.3.1	Class I	62
6.3.2	Class II	66
6.3.3	Groups	68
6.3.4	Ignition Temperature.....	68
6.3.5	Flammable (Explosion) Limits.....	68
6.3.6	Flashpoint.....	69
6.4	ELECTRICAL EQUIPMENT FOR CLASS I, II, AND III AREAS.....	69
6.4.1	Seals and Drains.....	69
6.5	DESCRIPTIONS, FEATURES, AND TEST CRITERIA OF ENCLOSURES FOR HAZARDOUS (CLASSIFIED) LOCATIONS (PER NEMA 250).....	71
6.5.1	Type 7 Enclosures	72
6.5.2	Type 8 Enclosures	72
6.5.3	Type 9 Enclosures	73
6.6	UNDERGROUND FACILITIES	74
6.6.1	Work on Electrical Equipment and Circuits.....	75
6.6.2	Power Cables and Conductors	75
6.6.3	Trailing Cables	76
6.6.4	Trolley Circuits for Track Haulage.....	76
7.0	REQUIREMENTS FOR SPECIFIC EQUIPMENT	77
7.1	CONVEYING SYSTEMS	77
7.1.1	Electrical Design Criteria.....	77
7.2	CRANES AND HOISTS	78
7.2.1	NEC General Requirements	78

DOE-HDBK-1092-2013

7.2.2	Disconnecting Means.....	78
7.2.3	Grounding	80
7.2.4	Control.....	80
7.2.5	Clearances	80
7.2.6	OSHA and NEC Requirements.....	80
7.2.7	Maintenance and Operations.....	80
7.2.8	Documented Maintenance	81
7.2.9	Mechanical Elevating and Rotating Equipment	81
7.3	ELEVATORS AND ESCALATORS.....	82
7.3.1	Codes and Standards	82
7.3.2	Design Specifications.....	82
7.3.3	Emergency Power.....	84
7.3.4	Design	84
7.3.5	Fire Protection.....	85
7.3.6	Inspections and Records	85
7.4	PORTABLE AND VEHICLE-MOUNTED GENERATORS	85
7.4.1	Ground Fault Circuit Interrupter	86
7.4.2	Grounding Portable and Vehicle-Mounted Generators.....	86
7.5	BATTERIES	86
7.5.1	Surrounding Space	86
7.5.2	Location.....	86
7.5.3	Ventilation	87
7.5.4	Conduit.....	87
7.5.5	Battery Room	87
7.5.6	Personal Protective Equipment.....	88
7.5.7	Tools	88
7.5.8	Storage Batteries and Battery Banks.....	88
8.0	WORK IN EXCESS OF 600 VOLTS	91
8.1	RESPONSIBILITIES FOR SAFETY	91
8.1.1	Workers.....	91
8.1.2	Supervisors	92
8.2	TRAINING	92
8.2.1	Employee Training	92
8.2.2	Qualified Employee Training.....	93
8.3	JOB BRIEFINGS.....	93
8.4	PERSONAL PROTECTIVE EQUIPMENT AND PROTECTIVE CLOTHING	94
8.4.1	Shoes	94
8.4.2	Hardhats.....	94
8.4.3	Eye Protectors.....	95
8.4.4	Conductive Articles	95
8.4.5	Work Gloves.....	95
8.4.6	Work Clothes.....	95
8.4.7	Fire-Resistant (FR) Arc-Rated (AR) Clothing	95
8.4.8	Rubber Gloves	96

DOE-HDBK-1092-2013

8.4.9	Rubber Line Hose, Hoods, Covers, Sleeves, and Blankets	97
8.4.10	Live Line Tools	97
8.4.11	Storeroom Storage.....	97
8.4.12	Truck Storage.....	97
8.4.13	Placing of Insulating Goods on Conductors.....	98
8.4.14	Removing Insulating Goods from Conductors	98
8.4.15	Cleaning and Inspecting	98
8.5	PROTECTIVE GROUNDING OF LINES AND EQUIPMENT	98
8.5.1	Purpose	98
8.5.2	Application.....	99
8.5.3	Grounding Equipment	101
8.5.4	Testing Before Installing Grounds.....	104
8.5.5	Attaching and Removing Grounds	104
8.5.6	Grounding Methods and Location of Grounds in Order of Preference	105
8.5.7	Testing Without Grounds	105
8.5.8	Ground Personnel	105
8.6	INSTALLING OR REMOVING CONDUCTORS	106
8.6.1	Working on Energized Line or Equipment	106
8.6.2	Stringing or Removing De-energized Conductors	106
8.6.3	Stringing Adjacent to Energized Lines	108
8.7	SPECIAL TOOLS.....	108
8.7.1	Lineworkers' Climbing Tools	109
8.7.2	Body Belts and Safety Straps	110
8.7.3	Tool Bag and Equipment	110
8.7.4	Tapes and Rulers.....	110
8.7.5	Spoon and Shovels.....	110
8.7.6	Pike Poles	110
8.7.7	Hand Axes and Sharp Tools.....	110
8.7.8	Handlines and Taglines	110
8.8	TREE TRIMMING	111
8.8.1	Care and Use of Tools	111
8.8.2	Climbing	111
8.9	UNDERGROUND	111
8.9.1	Working in Manholes, Utility Tunnels, and Vaults.....	111
8.9.2	Working on Energized Underground Cables	113
8.9.3	Terminals of Underground Cables (Potheads)	113
8.10	FERRO-RESONANCE.....	113
9.0	TEMPORARY WIRING	115
9.1	REQUIREMENTS AND INSTALLATION CONDITIONS OF USE.....	115
9.1.1	Contact Prevention.....	115
9.1.2	Vertical Clearances	115
9.1.3	Wet Locations	115
9.1.4	Bushings	115
9.1.5	Lighting.....	115

9.1.6	Confined Spaces	116
9.1.7	Exposed Sockets and Broken Bulbs.....	116
9.1.8	Ground Fault Protection for Personnel	116
9.1.9	Wiring Methods	116
9.2	Using Assured Equipment Grounding Conductor Program	117
9.3	PORTABLE ELECTRICAL TOOLS AND EQUIPMENT	118
9.3.1	Inspection and Maintenance	118
9.3.2	Conditions of Use.....	119
9.3.3	Use of Extension Cords	119
9.3.4	Double Insulated Tools	119
10.0	ELECTRICAL SAFETY DURING EXCAVATION	121
10.1	GENERAL	121
10.2	UTILITIES IDENTIFICATION.....	121
10.2.1	Configuration Management.....	121
10.2.2	Excavation Permit	122
10.3	UTILITIES VERIFICATION AND MARKING.....	122
10.3.1	Field Location of Excavation Boundaries.....	122
10.3.2	Locator Equipment Selection and Limitations.....	123
10.3.3	Locator Operator Training.....	124
10.3.4	Field Marking of Identified Utilities	125
10.4	UTILITIES DISPOSITION	125
10.5	WORK CONTROL DURING EXCAVATIONS	125
10.5.1	Safety Equipment and Procedures	125
10.6	THE EXCAVATION PROCESS	125
10.6.1	Excavations in Concrete Walls and Slabs	126
10.6.2	Machine or Hand Digging	126
10.7	AS-BUILT DRAWINGS	127
11.0	ENCLOSED ELECTRICAL/ELECTRONIC EQUIPMENT	128
11.1	GROUNDING AND BONDING	128
11.1.1	Objectionable Current over Grounding Conductors.....	128
11.1.2	Enclosure Equipment Grounding and Bonding.....	129
11.2	RACK POWER DISTRIBUTION	132
11.2.1	General Requirements Applying to All AC Power Equipment within or Attached to Instrument Racks	132
11.2.2	Conductors, Cords and Cables Specific Requirements.....	132
11.2.3	Power Switches and Interlock Devices Specific Requirements.....	134
11.3	CHASSIS POWER DISTRIBUTION	134
11.3.1	AC Power Distribution	135
11.3.2	DC Power Distribution.....	136
11.4	PROTECTIVE DEVICES FOR ENCLOSED ELECTRICAL/ ELECTRONIC EQUIPMENT	136
11.4.1	Surge Arresters	136
11.4.2	Fuses	136
11.4.3	Circuit Breakers.....	137
11.4.4	Power Interlock Devices	137
11.5	DISCONNECTING MEANS	137

DOE-HDBK-1092-2013

11.5.1 General 137

11.5.2 Emergency Shutdown 138

11.5.3 Special Considerations 138

11.6 MARKING AND LABELING REQUIREMENTS 138

11.6.1 General Marking Requirements 138

11.6.2 Hazard Marking Requirements 138

11.6.3 Other Requirements 138

11.7 WORKING CLEARANCE 139

11.8 CABLE/UTILITY MANAGEMENT SYSTEM 140

11.8.1 Usage with Enclosed Electrical/Electronic Equipment 140

11.8.2 Requirements 141

11.9 ELECTRICAL SAFETY REQUIREMENTS FOR TESTER FACILITIES 143

11.9.1 Ampacity of Facility Wiring and Distribution Equipment 143

11.9.2 Facility Grounding at Temporary or Remote Sites 143

11.9.3 Facility Lightning Protection 144

11.9.4 Surge Protection 144

11.10 ENCLOSED POWER ELECTRONICS 144

11.10.1 Enclosures 144

11.10.2 Component Clearances 144

11.10.3 Instrumentation 145

11.10.4 General 145

11.11 NON-IONIZING RADIATION 145

11.11.1 Electromagnetic Radiation 145

11.11.2 Electromagnetic Radiation Threat to Electro Explosive Devices 146

11.12 AMPACITY INFORMATION FOR WIRE SIZING 147

11.12.1 Ampacity Information 147

11.12.2 Color Coding Guidelines 148

12.0 APPROVAL OF UNLISTED ELECTRICAL EQUIPMENT 151

13.0 RESEARCH & DEVELOPMENT 152

13.1 OPERATION AND MAINTENANCE 152

13.2 EMPLOYEE QUALIFICATIONS 152

13.2.1 Hazards 152

13.2.2 Additional Qualifications 153

13.3 GENERIC R&D EQUIPMENT 153

13.3.1 Power Sources 153

13.3.2 Conditions of Low-Voltage and High-Current 154

13.3.3 Conditions of High-Voltage and Low-Current 155

13.3.4 Radio-Frequency/Microwave Radiation and Fields 156

13.4 METHODS 158

13.4.1 Wiring Methods 158

13.4.2 Unconventional Practices 159

13.4.3 Work on Energized or De-Energized Electrical Equipment 166

13.5 REQUIREMENTS FOR SPECIFIC R&D EQUIPMENT 166

13.5.1 Capacitors 167

DOE-HDBK-1092-2013

13.5.2	Inductors	170
13.5.3	Electrical Conductors and Connectors.....	171
13.5.4	Induction and Dielectric Heating Equipment.....	172
13.5.5	Batteries	173
13.5.6	Lasers and X-Ray Equipment.....	177
14.0	REFERENCES	179
APPENDIX A	DOE MODEL ELECTRICAL SAFETY PROGRAM	A-1
APPENDIX B	ACRONYMS AND DEFINITIONS	B-1
APPENDIX C	EXAMPLE PROGRAM FOR UNLISTED ELECTRICAL EQUIPMENT	C-1
APPENDIX D	HAZARD ANALYSIS	D-1
APPENDIX E	REFERENCED REGULATION CITATIONS	E-1
APPENDIX F	EXAMPLE OF A WAY TO MEASURE ELECTRICAL SEVERITY	F-1

1.0 INTRODUCTION

Generally, the guidance contained in this Department of Energy (DOE) *Handbook for Electrical Safety*, DOE-HDBK-1092-2013, for implementing electrical safety at DOE facilities is based on well-developed industrial practices, mandatory rules, or nationally-recognized consensus codes or standards. The guidelines are written to be flexible, so that they encompass the range from large, permanent DOE test or production facilities to small research or testing facilities. These guidelines form a compendium of good practices and describe key elements of programs that support electrical safety at DOE facilities. Implementation of these guidelines should result in a high level of performance and, therefore, contribute to safe work practices and work places that reduce the risk of exposure to electrical hazards for both people and property. Experience has shown that better performing facilities have well-defined, effectively-administered policies and programs to govern the activities of the people responsible for maintaining an electrically-safe workplace. These guidelines have, therefore, been prepared to assist facilities in the review and development of programs important to electrical safety.

These guidelines have been written to assist facilities in meeting performance and safety objectives related to electrical hazard reduction. It is intended that these guidelines be used to review existing or planned programs or facilities and to develop programs where none presently exist. It is expected that facilities may use different approaches or methods than those defined in the guidelines. Some expansion of the intent of the guidelines is provided in the introduction and discussion sections of each section, and the specific guidelines that follow reflect generally accepted methods for conducting an effective electrical safety program. Deviation from any particular guideline would not, in itself, indicate a programmatic problem. However, differences between the guidelines and actual practices should be reviewed to determine if a facility practice should be changed. A change in facility practice would be appropriate if a performance weakness is determined to exist. It is recognized that these guidelines cross into areas covered by multiple electrical safety references. During the development of this Handbook, no specific guidance was found to be in conflict with other DOE directives. If a user finds any conflicts, the matter should be resolved by bringing the issue to the attention of DOE's Office of Health, Safety and Security, Office of Worker Safety and Health Assistance, HS-12.

1.1 PURPOSE

The purpose of this Handbook is to present DOE's safety standards for its field offices or facilities involved in the use of electrical energy. It has been prepared to provide a uniform set of electrical safety guidance and information to assist DOE organizations in efforts to effect a reduction or elimination of risks associated with the use of electrical energy. The objectives of this Handbook are to enhance electrical safety awareness and mitigate electrical hazards to employees, the public, and the environment.

This Handbook does not supersede any existing standards or laws. Rather, this document offers methodologies that augment and support the intended safety objectives of applicable codes and standards.

1.2 SCOPE

This Handbook provides general information to enhance understanding of DOE orders (O), national codes, national standards, and local, state, and federal regulations. Each user should reference their contract document(s) and determine what legal requirements are to be followed in the area of electrical safety. These requirements and the implementing mechanisms may

vary by location. In other than the appendices of this document, "shall" refers to requirements of regulatory standards identified in the Code of Federal Regulations (CFR) in 10 CFR 851, *Worker Health and Safety Program*, that may or may not apply to a specific location (e.g. Southwestern Power Administration, Western Area Power Administration, Bonneville, etc.). Regulations designated by "shall" are referenced by superscript to the appropriate citation listed in Appendix E. "Should" refers to guidance from consensus standards that may not apply contractually, or to practices in use at various DOE sites. Where there are multiple references that reflect a particular rule, in some cases only one of the references is cited. References to the National Fire Protection Association's (NFPA) NFPA 70, *National Electric Code* (NEC), are taken from the 2008 edition. References to NFPA 70E, *Standard for Electrical Safety in the Workplace*, are taken from the 2009 edition. References to Occupational Safety and Health Administration (OSHA) regulations are taken from the 2007 edition. Appendices provide references, examples, definitions, and other information that enhances the material found in the body of the document.

The design of new facilities should conform to relevant DOE orders and industry-recognized engineering design standards. Existing facilities should evaluate their systems and operations in relation to this Handbook, applicable DOE orders, national codes, national standards, and local, state, and federal regulations to determine if they comply or if a safety problem exists. If the evaluation determines that an unacceptable risk of exposure to an imminent hazard exists, corrective actions should be initiated, including consideration to bring the systems or operations into compliance with current standards. In the case of a major renovation of an existing facility, the modification shall^{1.1} comply with current standards.

Existing facilities shall^{1.2} conform to 10 CFR 851, which permits compliance with an existing code of record and relevant DOE orders. The OSHA standards have specific requirements that shall^{1.3} apply to all electrical installations and utilization equipment, regardless of when they were designed or installed, and identify other mandatory provisions and specify effective dates. Installations in compliance with the code at the time of design or installation (code of record), do not need to be upgraded to the updated code unless required to correct a known hazard or a major modification is being performed.

1.3 ELECTRICAL SAFETY PROGRAM

Each DOE site shall^{1.4} establish an electrical safety program that meets the requirements of 10 CFR 851. Electrical safety programs should institute elements described in Appendix A "DOE Model Electrical Safety Program" of this Handbook. Electrical safety requirements shall^{1.5} flow down to all appropriate contractors and lower-tiered subcontractors and vendors.

1.4 AUTHORITY HAVING JURISDICTION

In states and municipalities, an organization (electrical safety committee or board) or official (electrical inspector, engineer, or equivalent qualified individual) is usually designated as the electrical Authority Having Jurisdiction (AHJ). The AHJ should possess such executive ability as is required for performance of the position, and should have thorough knowledge of standard materials and work practices used in the installation, operation, construction, and maintenance of electrical equipment. The AHJ should, through experience or education, be knowledgeable of the requirements contained in 10 CFR 851, OSHA standards, the Institute of Electrical and Electronic Engineers' (IEEE) *National Electrical Safety Code* (NESC) (IEEE/ANSI C-2), NFPA 70, NFPA 70E, DOE requirements, and other appropriate local, state, and national standards. The AHJ should be responsible to interpret codes, regulations and standards, and approve

equipment, assemblies, or materials. If the AHJ needs to address items outside their electrical expertise, such as fire, confined space, fall protection, or like issues, the AHJ should consult with cognizant experts before a decision is reached. The AHJ may permit alternate methods when it is assured that equivalent objectives can be achieved by establishing and maintaining effective safety equal to, or exceeding, established codes, regulations, and standards.

In DOE, levels of authority exist that serve the function of the AHJ. The AHJ may be the contracting officer, such as an area manager. This person may choose to delegate authority to an individual or organization within their control. It is acceptable for DOE sites to delegate authority to an appropriate committee (refer to Appendix A “DOE Model Electrical Safety Program” of this Handbook). The authority may reside with a safety or facilities department. The field office manager or designated representative may act as a higher level of authority. Per the Integrated Safety Management model, responsibility for electrical safety continues down to all workers. Figure 1-1 illustrates a typical AHJ and worker responsibility hierarchy.

DOE contractors should establish lines of authority within their organizations. It is important that a line of authority be established, documented, and recognized. Formal delegation should be obtained from the responsible DOE field office. The limits of the authority and recognition of a higher authority should be delineated. DOE, as the governing agency, is the ultimate authority for all decisions regarding mandatory electrical codes and standards.

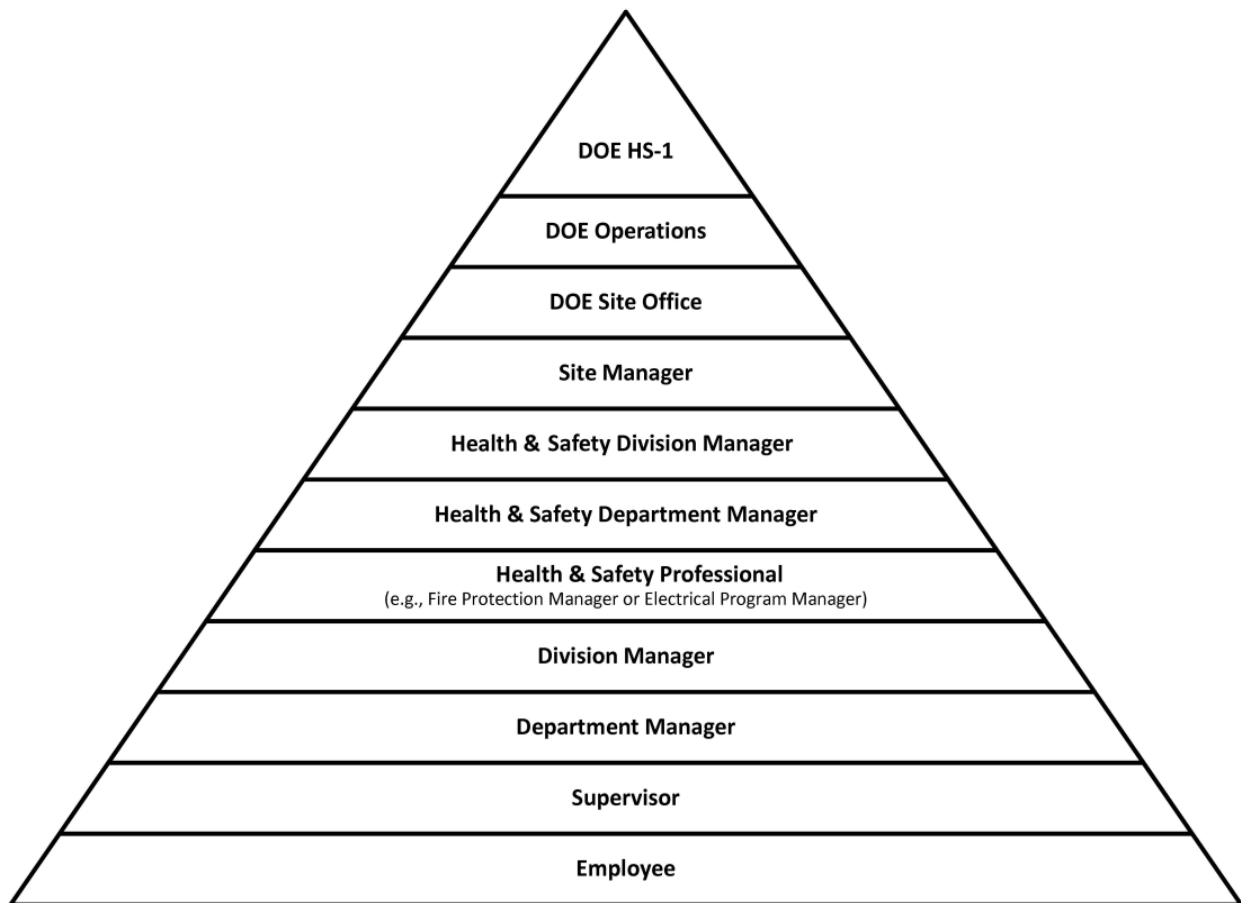

Fig. 1-1. Flow down of Electrical AHJ and worker responsibility.

2.0 GENERAL REQUIREMENTS

This section deals with the general requirements for a work environment free from exposure to electrical hazards. Protection of workers begins with careful planning and proper design. Safe work practices shall^{2.1} be used to safeguard employees from injury while they are exposed to electrical hazards. The training of personnel in safety-related work practices that pertain to their respective job assignments is discussed.

2.1 ELECTRICAL MAINTENANCE OR REPAIRS

Only qualified persons, which include persons working under the direct supervision of a qualified person, shall^{2.2} perform electrical repairs. Before any electrical maintenance or troubleshooting is performed, sources of hazardous electrical energy shall^{2.3} be placed in an electrically-safe work condition except when it is necessary for troubleshooting, testing, or areas that are infeasible.

2.1.1 Work on Electrical Equipment

The first consideration for working on any electrical system operating at 50 volts (V) or higher is to place the circuit in an electrically-safe work condition, which is defined in Appendix B. Work on energized circuits of 50 V or higher is not considered a routine activity. All circuits and equipment shall^{2.4} be considered energized until opened, tagged, and/or locked according to an approved procedure, and proven de-energized with an approved electrical test instrument known to be in proper working order. After de-energizing and where possible, the circuit should be challenged in some way (e.g. pressing the start button) to prove hazardous energy has been removed. A review of system drawings and/or system walk downs should be performed to identify all potential sources of electrical energy within the scope of planned work activity. Where the possibility exists that the circuit can become energized from other sources, or where capacitive devices (including cables) may retain or build up a charge, the circuit should be grounded and shorted. When equipment contains storage batteries, workers should be protected from the various hazards associated with those devices (See Section 7.5). Whenever work is to be performed on a de-energized system, the work plan shall^{2.5} also identify and provide for protection against any unplanned contact with exposed energized parts in the vicinity of the work. When electrical equipment contains sources of stored or mechanical hazardous energy (i.e. thermal, mechanical, pneumatic), these sources shall^{2.6} be blocked or otherwise relieved.

2.1.2 Considerations for Working on Energized Systems and Equipment

Energized parts to which an employee might be exposed shall^{2.3} be put into an electrically-safe work condition before the employee works on, or near them, unless the employer can demonstrate that de-energizing introduces additional or increased hazards or is infeasible due to equipment design or operational limitations.

If energized systems and equipment are not placed into an electrically-safe work condition, qualified and authorized employees performing such tasks as electrical repairs, modifications, demolition, servicing, troubleshooting, and testing on energized electrical systems, parts, and equipment, shall^{2.1} comply with the following:

1. Personnel shall^{2.7} not work on energized circuits unless they are qualified to do so, or they work under the direct supervision of a qualified person in an approved on-the-job training program.

2. Sufficient protection in the form of insulated tools, arc-rated (AR) apparel, insulated protective equipment, or other personal protective equipment (PPE) shall^{2.8} be used as necessary while working on or near exposed energized parts.
3. Other work, independent of voltage, that presents a significant shock, arc flash, or arc blast hazard to employees shall^{2.9} be analyzed and appropriate controls provided.

2.1.3 Safety Watch Responsibilities and Qualifications

Safety watch is an additional control that exceeds the regulatory requirements. The responsibilities and qualifications of personnel for sites that require the use of a safety watch should consider the following items:

1. Training in methods of release of victims from contact with electrical energy, cardiopulmonary resuscitation (CPR), and the use of automated external defibrillators (AED).
2. The possession of a thorough knowledge of location and operation of emergency-shutdown push buttons and power disconnects.
3. The possession of a thorough knowledge of the specific working procedures to be followed and the work to be done.
4. Specific safety watch responsibilities, including: monitoring the work area for unsafe conditions or work practices and taking necessary action to ensure abatement of the unsafe condition or work practices; de-energizing equipment and alerting emergency rescue personnel as conditions warrant; maintaining visual and audible contact with personnel performing the work; and the removal of injured personnel, if possible. The safety watch should have no other duties that preclude observing, rendering aid if necessary, and preventing unqualified persons from crossing the established safe approach boundaries.

2.2 BASIC SAFEGUARDS

To protect employees from electrical hazards, standards and federal regulations limit the performance of electrical work to qualified and authorized personnel. Specifically, OSHA requires that only a qualified person (per OSHA definition), or someone working under the direct supervision of a qualified person, is permitted to perform any repair, installation, or testing of electrical equipment. See Section 2.7 and the definitions of "Qualified Employee" or "Qualified Person" in Appendix B.

Following Integrated Safety Management System (ISMS) principles should improve the safety of the workplace:

1. Define Work Scope
 - a. Ensure that work is adequately planned through an approved work control process;
 - b. Plan and analyze for safety in each step of a project;
 - c. Conduct a pre-job briefing; and
 - d. Define response to changing scope or conditions.

2. Identify the hazards
 - a. Refer to system drawings and perform system walk downs with workers;
 - b. Identify potential hazards;
 - c. Maintain electrical equipment in accordance with the manufacturer's instructions; and
 - d. Post electrical hazard warning labels.
3. Establish controls
 - a. Use properly rated test equipment and verify its condition and operation before and after use;
 - b. Know and practice applicable emergency procedures;
 - c. Become qualified in CPR and first aid and maintain current certifications;
 - d. Inspect and wear appropriate PPE and apparel; and
 - e. Control access to work area.
4. Perform the work safely
 - a. Maintain good housekeeping and cleanliness;
 - b. Anticipate problems;
 - c. Resist pressure to "hurry up"; and
 - d. Maintain a questioning attitude.
5. Feedback
 - a. Document work; and
 - b. Conduct a post job briefing.

2.3 RESPONSIBILITIES

Management is responsible to provide a workplace that is free from recognized hazards that might cause injury, illness, or death and to comply with the specific safety and health standards issued by federal, state, and local authorities. Managers expect their employees to comply with these regulations as well as the DOE requirements formulated for the health and safety of employees. Prevention of injury and illness requires the efforts of all and is a goal well worth achieving.

2.3.1 Management Responsibilities

To ensure safety and protection of employees, managers have the following responsibilities:

1. Ensure that employees are provided a workplace that is free from recognized hazards;
2. Ensure that employees performing electrical work are trained and qualified (see Section 2.7);
3. Ensure that approved PPE and clothing is provided, available, and used properly; and
4. Establish, implement, and maintain procedures and practices that ensure safe conduct of electrical work.

2.3.2 Employee Responsibilities

Employees are responsible to comply with occupational safety and health regulations and standards that apply to their own actions and conduct, including immediately reporting to management unsafe and unhealthful conditions.

See Section 8.1 for additional responsibilities of employees working on or around electrical equipment or systems operating above 600 volts.

2.4 MODIFICATIONS TO FACILITIES

Modifications to existing and new facilities should be subject to inspection by the AHJ, or authorized designee, to verify compliance with the codes and standards in effect on the date that the work was approved by a final design review. If the installation involves a hazard to life, equipment, or property, current standards and codes should be used to mitigate the hazard.

2.5 APPROVAL OF ELECTRICAL EQUIPMENT

Generally, consensus codes and standards do not obligate the user to retrofit existing installations to more current editions of the document. However, according to OSHA, there are installation requirements in 29 CFR 1910.303-308 that require compliance based on the date of original installations. In some cases, compliance is required regardless of installation date. Whenever a modification invalidates the original approval by the AHJ, the modification should meet the most current code or standard. An inspection should validate compliance. Generally, minor equipment modifications should not warrant complete update to current codes and standards unless the AHJ determines the lack of conformity to current codes and standards presents an imminent danger.

All electrical equipment, components, and conductors shall^{2.10} be approved for their intended use, which means they are acceptable to the AHJ. There are several methods for determining acceptability to the AHJ, including: listing by a nationally recognized testing laboratory (NRTL), field evaluations by an NRTL or an inspection and approval by the AHJ or designee. Electrical utility generation, transmission and distribution equipment built to nationally recognized standards is considered acceptable.

2.6 CODES, STANDARDS, AND REGULATIONS

Electrical or electronic equipment and work performed on these installations, shall^{2.11} comply with 10 CFR 851, DOE orders, state and local requirements (where applicable), and, where applicable, other relevant standards, regulations, codes, etc. from organizations, such as:

1. Institute of Electrical and Electronics Engineers (IEEE)
2. International Society of Automation (ISA)
3. National Electrical Manufacturers Association (NEMA)
4. American National Standards Institute (ANSI)
5. American Society for Testing and Materials (ASTM)
6. National Fire Protection Association (NFPA)
7. NRTL's recognized by OSHA, such as:
 - a. Underwriters Laboratory, Inc. (UL)

b. Factory Mutual Research Corporation (FMRC)

8. National Electrical Installation Standards (NEIS)

When no clear applicable code or standard provides adequate guidance or when questions regarding workmanship, judgment, or conflicting criteria arise, personnel safety protection shall^{2.12} be the primary consideration. Therefore, when there are differing controls for similar hazards identified in the mandatory requirements of the relevant codes, standards, and regulations, the requirements that address the particular hazard and provides for the greatest margin of safety should govern.

2.7 TRAINING AND QUALIFICATIONS OF QUALIFIED WORKERS

Only qualified workers or those working under the direct supervision of a qualified person in an on-the-job training program shall^{2.2} perform work on electrical systems. There shall^{2.13} be an employee training program implemented to qualify workers in the safety-related work practices that pertain to their respective job assignments.

2.7.1 Formal Training and Qualifications

According to 10 CFR 851 which references such standards as NFPA 70E, 110.6(D), the employer is obligated to provide training and qualifications for qualified workers before they are permitted to perform electrical work. Refresher training is recommended at intervals, not to exceed three years, to provide an update on new regulations and electrical safety criteria.

The training shall^{2.14} include on-the-job and/or instructor-led methods in a classroom setting. Portions of the training may be provided using self-paced methods such as self-study of print material, web-based training or computer-based training. The degree of training provided should be determined by the risk to the employee. This training shall^{2.15} be documented. Qualified employees shall^{2.16} be trained and familiar with, but not be limited to, the following:

1. Safety-related work practices, including hazard identification and analysis, and proper selection, use and care of PPE, that pertain to their respective job assignments.
2. Skills and techniques necessary to distinguish exposed energized parts from other parts of electrical equipment.
3. Skills and techniques necessary to determine the nominal voltage of exposed energized parts, clearance distances, and the corresponding voltages to which the qualified person might be exposed.
4. Procedures on how to perform their jobs safely and properly.
5. How to lockout/tagout energized electrical circuits and equipment safely.
6. Approach distances defined in NFPA 70E.
7. Knowledge to select and use adequately rated test instruments.

Other types of training to be considered for electrical workers should include the following:

1. *National Electrical Code* (NFPA 70);
2. *National Electrical Safety Code* (IEEE/ANSI C2);
3. *Standard for Electrical Safety in the Workplace* (NFPA 70E);
4. Use of personal protective grounds;

5. Work permit and work authorization procedures;
6. Proper clothing required for arc flash or arc blast protection; and
7. First-aid, CPR, AED, and methods of release training.

OSHA under 29 CFR 1910.269(a), *Electric Power Generation, Transmission, and Distribution*, and 1910.332, *Electrical Training*, also require training for persons other than qualified workers if their job assignments bring them within a safe distance of hazardous electrical energy.

Supervisors of unqualified personnel should have at least the same level of electrical safety training if the work of those they supervise bring them close enough to exposed parts of electrical circuits for a hazard to exist.

2.7.2 Training of Safety Personnel

Safety personnel designated to support electrical safety programs should be knowledgeable and trained at levels commensurate with their duties. Supervisors directly supervising energized work should have at least the same level of electrical safety training as the workers they supervise.

2.7.3 Training of Technical Personnel

In addition to electrical safety training requirements, DOE Order 426.2 provides criteria for technical personnel supporting an operating nuclear facility. According to the order, not only do affected personnel require basic qualification training, but their qualification is to be recertified every two years.

2.8 WORKING SPACE AROUND ELECTRICAL EQUIPMENT

Working space around electrical enclosures or equipment shall^{2.17} be adequate for conducting all anticipated maintenance and operations safely, including sufficient space to ensure safety of personnel working during emergency conditions and workers rescuing injured personnel. Spacing shall^{2.18} provide the dimensional clearance (addressed in the following subsections) for personnel access to equipment likely to require examination, adjustment, servicing, or maintenance while energized. Such equipment includes panelboards, switches, circuit breakers, switchgear, controllers, and controls on heating and air conditioning equipment.

These clearances should be in accordance with the most restrictive of OSHA, NESC, or NEC requirements. These working clearances are not required if the equipment is not likely to require examination, adjustment, servicing, or maintenance while energized. However, sufficient access and working space is still required.

Sufficient working space is necessary for the protection of workers to ensure there is adequate space for safe egress and entry into areas where energized work is likely. Dedicated space, which includes the area directly above electrical equipment, is necessary for the protection of electrical equipment and to allow for safe future expansion. See OSHA and NFPA 70 (NEC) for more information on clearing space and dedicated space.

2.8.1 Electrical Equipment Rated at 600 Volts or Less

A minimum working space 30 inches wide shall^{2.18} be provided in front of electrical equipment rated at 600 V or less and is likely to require servicing while energized. This provides room to

avoid body contact with grounded parts while working with energized components of the equipment. The 30-inch wide space may be centered in front of the equipment or can be offset. The depth of the working space shall^{2.19} be clear to the floor. Where rear access is required to work on de-energized parts, a minimum of 30 inches shall^{2.20} be provided. There shall^{2.21} be clearance in the work area to allow at least a 90-degree opening of equipment doors or hinged panels on the service equipment. Working spaces may overlap. The depth of the working space shall^{2.18} be 3 feet, 3.5 feet, or 4 feet, depending upon existing conditions. The conditions are as follows:

1. Condition 1: Exposed live parts on one side of the working space and no live or grounded parts on the other side of the working space, or exposed live parts on both sides of the working space that are effectively guarded by insulating materials.
2. Condition 2: Exposed live parts on one side of the working space and grounded parts on the other side of the working space. Concrete, brick, or tile walls shall^{2.22} be considered as grounded.
3. Condition 3: Exposed live parts on both sides of the working space.

See Fig. 2-1 for the clearance requirements in front of electrical equipment rated 600 V or less.

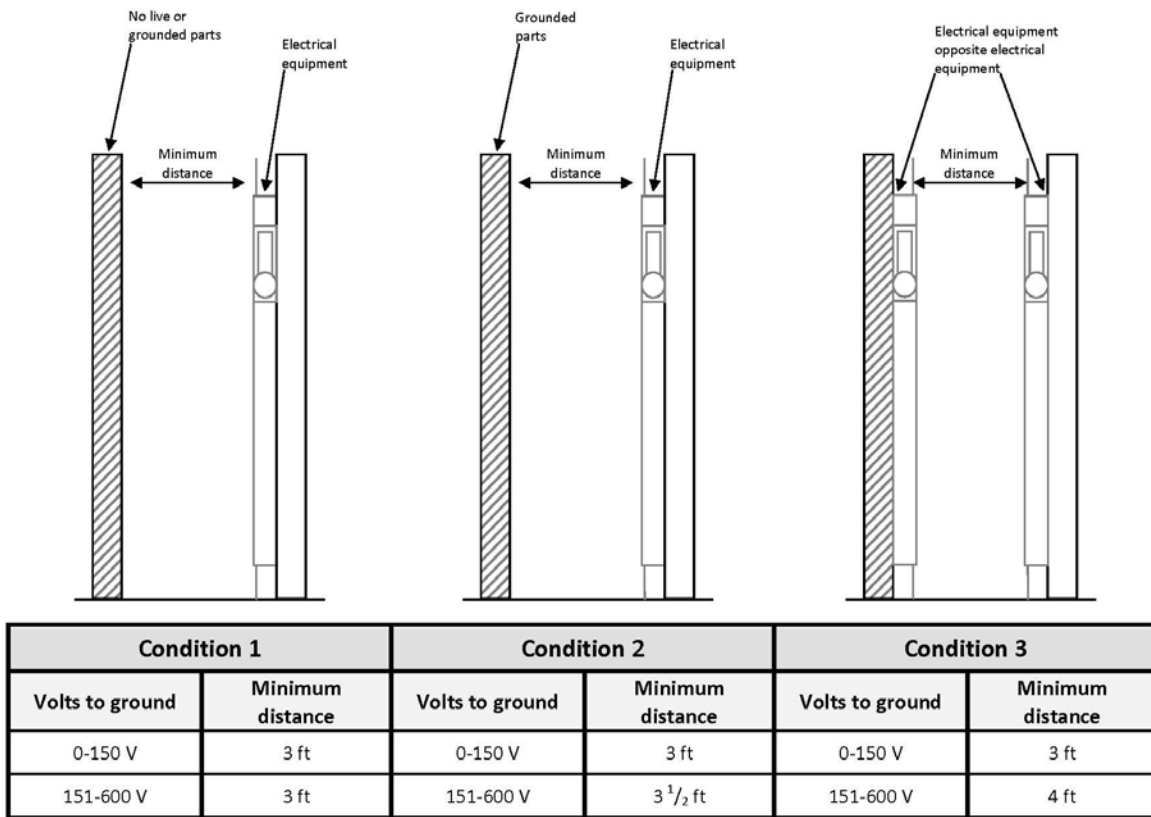

NEC Table 110-16 (a)
OSHA Table S-1

Fig. 2-1. Minimum clearances in front of electrical equipment (600 V or less).

2.8.2 Electrical Equipment Rated over 600 Volts

OSHA and the NEC lists minimum clearances required for working spaces in front of high-voltage electrical equipment such as switchboards, control panels, switches, circuit breakers, switchgear, and motor controllers.

There are three conditions to apply:

1. Exposed live parts on one side of the working space and no live or grounded parts on the other side of the working space, or exposed live parts on both sides of the working space that are effectively guarded by insulating materials.
2. Exposed live parts on one side of the working space and grounded parts on the other side of the working space. Concrete, brick, or tile walls shall^{2,23} be considered as grounded.
3. Exposed live parts on both sides of the working space.

See Fig. 2-2 for the clearance requirements in front of electrical equipment rated at over 600 V.

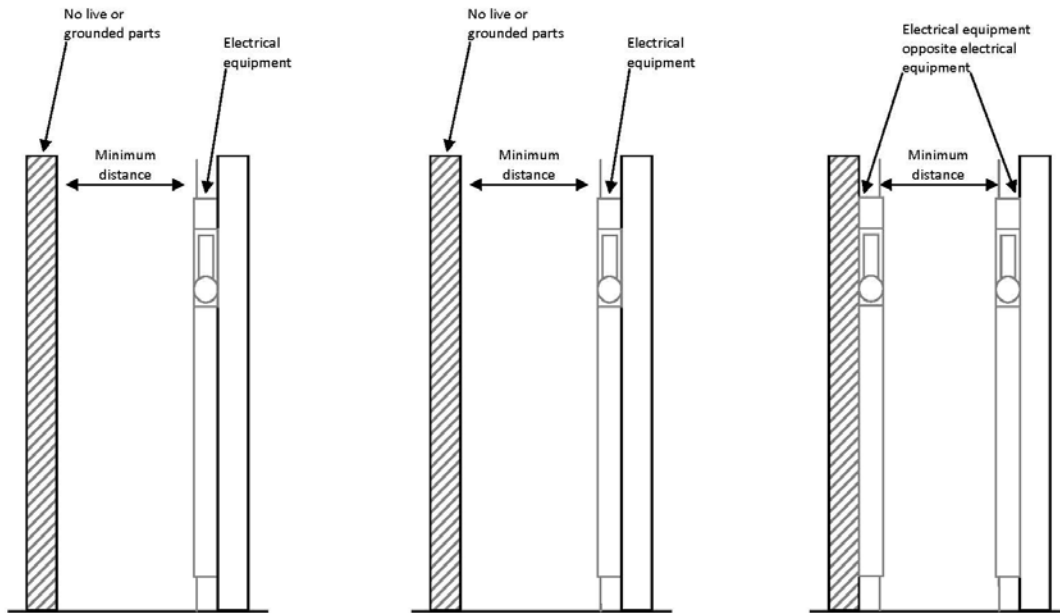

Condition 1		Condition 2		Condition 3	
Volts to ground	Minimum distance	Volts to ground	Minimum distance	Volts to ground	Minimum distance
601-2,500 V	3 ft	601-2,500 V	4 ft	601-2,500 V	5 ft
2,501-9,000 V	4 ft	2,501-9,000 V	5 ft	2,501-9,000 V	6 ft
9,001-25,000 V	5 ft	9,001-25,000 V	6 ft	9,001-25,000 V	8 ft
25,001-75,000 V	6 ft	25,001-75,000 V	8 ft	25,001-75,000 V	10 ft
Above 75,000 V	8 ft	Above 75,000 V	10 ft	Above 75,000 V	12 ft

NEC Table 110-34
OSHA Table S-2

Fig. 2-2. Minimum clearances in front of electrical equipment (over 600 V).

2.9 IDENTIFICATION OF DISCONNECTING MEANS

Disconnecting means in service panels, subpanels, or elsewhere shall^{2.24} be marked to show what loads or equipment are supplied, unless located and arranged so that the purpose is evident.

2.9.1 Disconnecting Means

Disconnecting means (e.g., a disconnect switch or circuit breaker) shall^{2.25} be located for easy access and shall^{2.24} be clearly and permanently marked to show the purpose of the disconnecting means, unless located and arranged so that the purpose is evident. Labeling should match and be traceable to appropriate drawings. This applies to all existing electrical systems and all new, modernized, expanded, or altered electrical systems. Disconnecting means shall^{2.26} be capable of being locked out where required.

2.9.2 Panelboard Circuit Directories

Panelboard circuit directories shall^{2.24} be provided and maintained accurate.

2.9.3 Enclosure Labeling

Printed labeling or embossed identification plates affixed to enclosures shall^{2.24} comply with the requirements that disconnects are legibly marked and that the marking shall^{2.24} be of sufficient durability for the environment involved.

2.9.4 Load Labeling

As with the disconnecting device, the load should be labeled. For example, the motor, the controller, and the disconnecting device could have the same identification number.

2.9.5 Source Labeling

The source supplying power to the disconnecting means and load should be labeled as well. This good practice allows the electrical worker to know the identification of the elements from the source of power through the entire circuit. (See Fig. 2-3.)

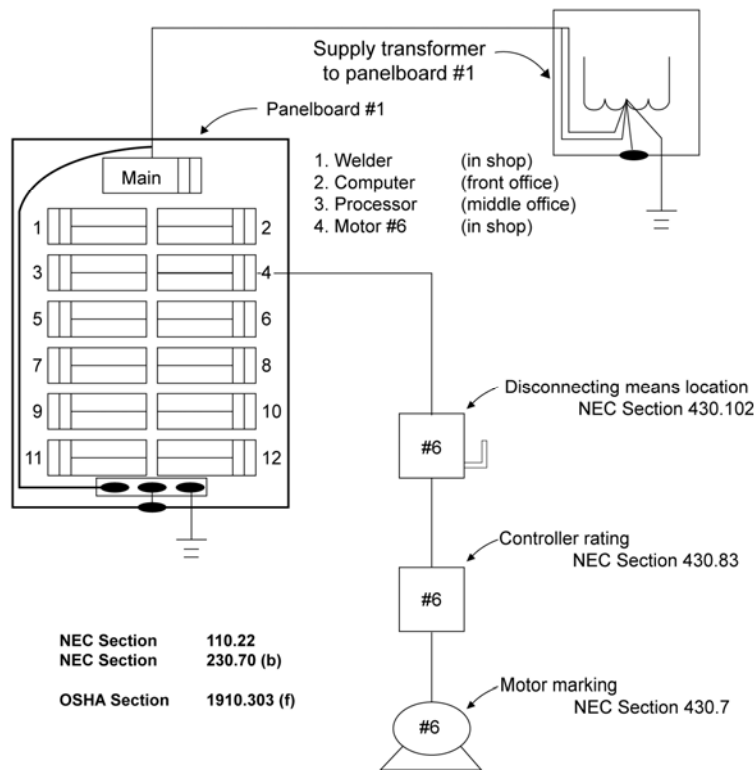

Fig. 2-3. Marking of disconnecting means.

2.10 WORK INSTRUCTIONS

Before electrical work begins, the qualified worker should review and understand the work instructions to ensure the work can be performed safely and compliantly.

2.10.1 Safe Work Instructions and Supervision

Electrical work should be performed according to safety procedures. Energized electrical work should be directed by a supervisor who is qualified by training and experience in the applicable safety-related work practices.

Workers should report any electrical hazards to their immediate supervisor. The supervisor should take all corrective actions necessary to address an employee's concerns.

Electrical instructions shall^{2.27} be based on a thorough analysis of the job and its hazards. If the same task is repeated, it may be performed under specific work rules that are based on such analyses.

2.10.2 Work Planning

Electrical work planning may include, but not be limited to, the following:

1. Hazardous Energy Control (Lock Out/Tag Out)
2. Shock Hazard Analysis
3. Flash Hazard Analysis

4. Safe work practices necessary to prevent exposure of the workers to electrical hazards
5. Methods of using test equipment to ensure safe conditions
6. Provision that insulated protective equipment is rated for the highest voltage present
7. Qualification requirements of personnel (see Section 2.7)
8. PPE and protective clothing (e.g., hardhats, safety shoes, eye and face protection, insulated live-line tools/barriers, hot sticks, AR clothing, and arc flash protection, etc.)
9. Special provisions for working on experimental equipment
10. The need to conduct a pre-job safety briefing
11. Temporary protective grounding equipment
12. Temporary lighting
13. Consideration for "what can go wrong"
14. Incorporating lessons learned from similar work tasks
15. Worker feedback in the planning process

2.11 ELECTRICAL PERSONAL PROTECTIVE EQUIPMENT

Qualified workers are responsible for avoiding and preventing accidents while performing electrical work, repairs, or troubleshooting electrical equipment. Personnel shall^{2.28} wear PPE and protective clothing that is appropriate for safe performance of work. Personnel shall^{2.29} wear appropriate AR clothing and PPE whenever there is potential exposure to an electrical arc flash. Required AR clothing shall^{2.30} meet the requirements of ASTM F 1506, *Standard Performance Specifications for Flame Retardant Textile Materials for Wearing Apparel for Use by Electric Workers Exposed to Momentary Electric Arc and Related Thermal Hazards*.

2.11.1 Management's Responsibilities

Managers shall^{2.31} ensure that appropriate PPE is provided, used, and that employees using PPE are trained in the proper use of the PPE.

2.11.2 Inspecting PPE

Employees shall^{2.32} visually inspect PPE and protective clothing prior to use, as well as after any work performed that could have damaged the PPE or apparel. Such inspections shall^{2.32} include a field air test of the gloves used. Visual inspection shall^{2.33} be performed on hot sticks, grounds, aerial lift equipment and booms, rope, ladders, insulated tools, AR clothing, etc. Equipment that does not successfully pass visual inspection shall^{2.34} not be used and shall^{2.34} be returned for repair and testing or disposal.

2.11.3 Cleaning and Electrical Testing of PPE

Rubber-insulated PPE issued for use shall^{2.34} receive periodic cleaning and electrical testing in accordance with the requirements of 29 CFR 1910.137 and the appropriate ANSI/ASTM standards. The intervals of retest for rubber goods issued for service shall^{2.35} not be more than 6 months for gloves, and 12 months for sleeves and blankets. Gloves or sleeves that have been electrically tested, but not issued for service, shall^{2.35} not be placed into service unless they have been electrically tested within the previous 12 months. A record of testing of PPE should be maintained according to applicable standards.

AR apparel that becomes contaminated with grease, oil, or flammable liquids or combustible materials should not be used. The garment manufacturer's instructions for care and maintenance should be followed. When AR clothing is cleaned, manufacturer's instructions should be followed to avoid loss of protection. When AR clothing is repaired, the same AR materials used to manufacture the AR clothing should be used to repair the garment.

2.11.3.1 Testing

All testing methods, apparatus, and facilities shall^{2.34} meet the applicable ANSI/ASTM standards. The method used and the results of such tests should be documented and made available for inspection.

2.11.3.2 Retested PPE

Retested rubber-insulated PPE shall^{2.34} be identified to indicate the date of the latest test, or date of retest, in accordance with the appropriate standard cited in 29 CFR 1910.137, *Standards on Electrical Protective Equipment*. Manufacturer's recommendations shall^{2.34} be followed on the type of paint or ink to be used.

2.11.4 Live-Line Tools

Live-line tools shall^{2.36} be cleaned and inspected before use and receive a dielectric test whenever their insulating value is suspect. A record of the testing of live-line tools shall^{2.37} be maintained.

2.11.5 Fiberglass-Handled Tools

Fiberglass-handled tools shall^{2.38} be designed and constructed by the manufacturer to withstand 100 kV per foot of length. The in-service test shall^{2.39} be 75 kV per foot.

2.11.6 Maximum-Use Alternating Current (AC) Voltage

Maximum-Use AC voltage phase-to-phase or phase-to-ground for insulating blankets, mats, covers, line hose, sleeves, and gloves, as shown in Table 2-1 shall^{2.34} be as follows:

Class	Voltage	Label Color
00	500	Beige
0	1,000	Red
1	7,500	White
2	17,500	Yellow
3	26,500	Green
4	36,000	Orange

Table 2-1. Class and rating of rubber insulating PPE.

2.11.7 Maximum Usage Voltage for Live-Line Tools

Maximum usage voltage per foot of length and phase-to-phase or phase-to-ground for live-line tools shall^{2.40} be as follows:

1. Tools with wooden handles: 75 kV

2. Tools with fiberglass handles: 100 kV

2.11.8 Rubber-Insulated Gloves

Whenever rubber-insulated protective gloves are required for shock protection, approved protective gloves shall^{2.41} also be worn. In some cases, rubber-insulated protective gloves may be used without protectors, see 29 CFR 1910.137 and referenced standards for those conditions.

2.11.9 Storage

Electrical insulating and protective clothing and equipment should be stored lying flat, undistorted, right-side out, and unfolded, as appropriate, in protective containers. Blankets may be stored rolled provided the inner diameter of the roll is at least 2 inches.

Rubber goods shall^{2.42} be stored in a location that is as cool, dark, and dry as possible. The location should be as free as practicable, from ozone, chemicals, oils, solvents, damaging vapors and fumes, and away from electrical discharges and sunlight. Rubber gloves should be stored cuff-down in a bag, box, or container designed for rubber glove storage. Rubber gloves may be kept inside of leather protectors.

2.11.10 Safety Shoes, Hardhats, and Glasses

Safety shoes (ASTM F 2413, *Standard Specification for Performance Requirements for Protective (Safety) Toe Cap Footwear*, and F 2412, *Standard Test Methods for Foot Protection*), hardhats (ANSI/ISEA Z89.1, *American National Standard for Industrial Head Protection*), and safety glasses (ANSI/ASEE Z87.1, *Occupational and Educational Personal Eye and Face Protection Devices*) and face shields (ASTM F 2178, *Standard Test Method for Determining the ARC Rating and Standard Specification for Face Protective Products*) worn by electrical workers shall^{2.43} meet the requirements of appropriate standards.

2.12 WORK PRACTICES

NFPA 70E, OSHA regulations, and the NESC cover electrical safety-related work practices and procedures for qualified and unqualified employees exposed to energized electrical conductors or circuit parts in workplaces. This information provides a foundation for establishing an electrically-safe working environment. Basic work strategies include:

1. Establishing an electrically-safe work condition;
2. Training (see Section 2.7);
3. Planning the work;
4. Identifying required personal protective equipment; and
5. Utilizing Energized Electrical Work Permits, when required.

2.12.1 Establishing an Electrically-Safe Work Condition

As referenced in 10 CFR 851, NFPA 70E, 120.1 provides a six-step process for achieving an Electrically-Safe Work Condition. For transmission and distribution work in excess of 600 V see 29 CFR 1910.269.

2.12.1.1 Exposed Energized Parts

Energized parts to which an employee may be exposed shall^{2.3} be de-energized before the employee works on, or near, them, unless it can be demonstrated and documented that de-energizing introduces additional or increased hazards or is infeasible because of equipment design or operational limitations (see Section 2.1.2).

2.12.1.2 Safe Procedure

Safe procedures for de-energizing circuits and equipment shall^{2.44} be determined before circuits or equipment are de-energized. De-energization procedures shall^{2.45} be included in the lockout/tagout procedure for the circuit or equipment to be de-energized.

2.12.1.3 Circuits and Equipment

Circuits and equipment to be worked on shall^{2.45} be disconnected from all electric energy sources. Control circuit devices such as push-buttons, selector switches, and interlocks shall^{2.45} not be used as the sole means for isolating circuits or equipment.

2.12.1.4 Stored Electrical Energy

Stored electrical energy that might endanger personnel shall^{2.46} be placed in a safe state. Capacitors shall^{2.46} be discharged and high-capacitance elements shall^{2.46} be short-circuited and grounded if the stored electrical energy could endanger personnel.

2.12.1.5 Stored Non-Electrical Energy

Stored non-electrical energy in devices that could re-energize electric circuit parts shall^{2.47} be blocked or relieved to the extent that the device could not accidentally energize the circuit parts. Examples include wound springs and pneumatic-driven devices.



OSHA sections 29 CFR 1910.147, 1910.269 (d) and (m), 1910.333, and 1926.417

Fig. 2-5. A lockout/tagout program is required.

2.12.1.6 Lockout/Tagout Procedure

Each employer shall^{2.48} document and implement lockout/tagout procedures to safeguard employees from injury while they are working on or near de-energized electric circuits and equipment. The lockout/tagout procedures shall^{2.49} meet the requirements of 29 CFR 1910.147(c) to (f), *The Control of Hazardous Energy (lockout/tagout)*, 1910.269(d) and (m), 1910.333, *Selection and Use of Work Practices*, 1926.417, *Lockout and Tagging of Circuits*,

DOE-STD-1030-96, Guide to Good Practice for Lockouts and Tagouts, and NFPA 70E, as applicable (see Fig. 2-5).

2.12.1.7 Verification of De-energized Condition

Verification shall^{2.50} be made to ensure that all circuits, parts, and other sources of electrical energy, including mechanical energy, have been disconnected, released, or restrained. All electrical circuit conductors and circuit parts shall^{2.4} be considered energized until the source of energy is removed and verified.

A qualified worker shall^{2.51} operate the equipment operating controls, perform voltage verification, and inspect open switches and draw out breakers to ensure that energy sources are isolated.

2.12.1.8 Voltage Verification Test

A qualified worker shall^{2.50} use appropriate test equipment to test the circuit elements and electrical parts of equipment to which employees will be exposed and shall^{2.50} verify that the circuit elements and equipment parts are de-energized. The test shall^{2.50} also determine if a hazardous energized condition exists as a result of induced voltage or voltage backfeed after specific parts of the circuit have been de-energized. The test equipment shall^{2.52} be checked for proper operation immediately before and immediately after this test. Testing shall^{2.53} be performed as if the circuit is energized, wearing the appropriate PPE. The voltage verification device used shall^{2.52} be rated for the application. Proximity testers and solenoid-type devices shall^{2.52} not be used to test for the absence of voltage for purposes of establishing lockout/tagout. Use of low-impedance test instruments should be considered when there is the possibility of small induced voltages to detect when those voltages would be hazardous.

2.12.1.9 Application of Personnel Protective Grounds

Personnel protective grounds shall^{2.54} be applied on circuits where residual charges may accumulate. Personnel protective grounds shall^{2.54} be selected and installed in accordance with appropriate standards (see Sections 8.5 and 13.5.1.2.2). Consideration should be given to step and touch potentials in the area of the temporary ground connections.

2.12.1.10 Re-energizing Equipment

The requirements in the following subsections shall^{2.55} be met before circuits or equipment are re-energized, even on a temporary basis:

2.12.1.10.1 Tests and Visual Inspections

A qualified worker shall^{2.56} verify that all personnel are in the clear and that all tools, electrical jumpers, shorts, grounds, and other such devices have been removed, so that the circuits and equipment can be safely energized.

2.12.1.10.2 Warning Employees

Employees exposed to the hazards associated with re-energizing the circuit or equipment shall^{2.57} be warned to stay clear of circuits and equipment.

2.12.1.10.3 Removing Lock and Tag

Each lock and tag shall^{2.58} be removed by applying the following:

1. Each lockout or tagout device shall^{2.58} be removed from each energy-isolating device by the authorized employee who applied the lockout or tagout device, or under his/her direct supervision, or as stated below.
2. When the authorized employee who applied the lockout or tagout device is not available to remove it, that device may be removed under the direction of his or her supervisor. Specific procedures shall^{2.59} be followed, including, at a minimum, the following elements:
 - a. Verification by the supervisor that the authorized employee who applied the device is not at the affected facility.
 - b. Making all reasonable efforts to contact the authorized employee to inform him or her that the lockout or tagout device has been removed.
 - c. Ensuring that the authorized employee has this knowledge before he or she resumes work at the affected facility.

2.12.2 Training

Qualified workers shall^{2.60} be knowledgeable of, and trained in, safety-related work practices, safety procedures, and other requirements that pertain to their respective job assignments. Employees shall^{2.61} not be permitted to work in an area where they are likely to encounter an electrical hazard, unless they have been trained to recognize and avoid these hazards. (See Section 2.7.)

2.12.3 Planning the Work

Whenever electrical equipment is taken from its accepted and static condition, an appropriate level of hazard analysis and work planning shall^{2.62} be completed before a worker is dispatched to manipulate the equipment. The analysis and associated work instructions shall^{2.62} account for any electrical hazards that result from the assigned task.

Hazard controls shall^{2.63} be selected based on the following hierarchy:

1. Elimination or substitution of the hazards where feasible and appropriate.
2. Engineering controls where feasible and appropriate.
3. Work practices and administrative controls that limit worker exposures.
4. Personal protective equipment.

2.12.3.1 Safe Work Instructions and Supervision

Before electrical work begins, the qualified worker should review and understand the work instructions to ensure the work can be performed safely and compliantly.

Electrical work should be performed according to safety procedures. A supervisor who is qualified by training and experienced in the applicable safety-related work practices should direct energized electrical work.

Workers should report any electrical hazards to their immediate supervisor. The supervisor should take all corrective actions necessary to address an employee's concerns.

Electrical instructions shall^{2.64} be based on a thorough analysis of the job and its hazards. If the same task is repeated, it may be performed under specific work rules that are based on such analyses.

2.12.3.2 Hazard Analysis and Control

Electrical hazard analysis and control considerations may include, but not be limited to, the following:

1. Hazardous Energy Control (Lock Out/Tag Out);
2. Shock Hazard Analysis;
3. Flash Hazard Analysis;
4. Safe work practices necessary to prevent exposure of the workers to electrical hazards;
5. Methods of using test equipment to ensure safe conditions;
6. Provision that insulated protective equipment is rated for the highest voltage present;
7. Qualification requirements of personnel (see Section 2.7);
8. PPE and protective clothing (e.g., hardhats, safety shoes, eye and face protection, insulated live-line tools/barriers, hot sticks, AR clothing, and arc flash protection, etc.);
9. Special provisions for working on experimental equipment;
10. The need to conduct a pre-job safety briefing;
11. Temporary protective grounding equipment;
12. Temporary lighting;
13. Consideration for "what can go wrong";
14. Incorporating lessons learned from similar work tasks; and
15. Worker feedback in the planning process.

2.12.3.3 Safe Energized Work (Hot Work)

If live parts are not placed into an electrically-safe work condition, work to be performed shall^{2.65} be considered energized electrical work and shall^{2.65} be performed by written permit only. Work performed on energized conductors by qualified persons related to tasks such as testing, trouble-shooting, voltage measuring, etc., shall^{2.66} be permitted to be performed without an energized electrical work permit, provided appropriate safe work practices and PPE are provided and used.

Safety-related work practices shall^{2.27} be used to prevent electrical shock or other electrically induced injuries when employees work on, or near, electrical conductors or circuit parts that are energized. Only qualified workers who are knowledgeable and have been trained to work safely on energized circuits and trained to use the appropriate PPE, protective clothing, insulating shielding materials, insulated tools shall^{2.67} be permitted to work on energized conductors or circuit parts and have an authorized energized work permit (refer to NFPA 70E, Article 130.1).

2.12.3.4 Approach Distance

No unqualified employee shall^{2.60} be permitted to approach closer to exposed, energized lines or parts than the Restricted Approach Boundary. The unqualified worker shall^{2.60} be permitted to cross the Limited Approach Boundary only when continuously escorted by a qualified worker.

No worker shall^{2.68} approach or take any conductive object, including jewelry, nearer to exposed live parts than the Restricted Approach Boundary.

2.12.3.5 Multiple Workers

Due to the potential for exposure to energized parts, electrical work that presents a shock or arc flash hazard to employees should be analyzed to determine the necessary number of employees involved.

2.12.3.6 Illumination and Egress Routes

Adequate illumination shall^{2.69} be provided and emergency routes should be identified before workers are allowed to enter spaces containing exposed energized parts.

2.12.3.7 Systems Under Load

Electrical equipment intended to switch current should have a rating sufficient for the current. Manual switches and disconnects, taps, terminators, and non-enclosed switches should not be operated while under load, unless the devices are rated as load-break type and are so marked.

2.12.3.8 Working with Test Instruments and Equipment

Sometimes it becomes necessary to check the continuity of power circuits, control circuits, etc., by using a particular testing instrument (volt, ohm, and/or amp meter) designed for the testing involved. The voltage device used shall^{2.70} be rated for the application. Proximity testers and solenoid-type devices shall^{2.70} not be used to test for the absence of voltage, except for applications above the service point, because they do not accurately detect and/or measure voltage. Also, proximity testers do not detect direct current (DC) or AC voltage in a cable that is shielded. Proximity testers are very useful in certain applications, (for example, for finding cables that go through a panel, but that do not terminate in the panel, or for testing energized electrical equipment ahead of the service point). However, it should be noted that a proximity tester's failure to detect voltage does not guarantee that the equipment or device is de-energized. The absence of voltage shall^{2.70} only be verified with a voltmeter rated for the application. When appropriate, test instruments and associated leads, probes, etc. should meet the American National Standard for voltmeters, ANSI/ISA/UL-61010-1, *Safety Requirements for Electrical Equipment for Measurement, Control, and Laboratory Use*. Appropriate category rated and listed meters should be used.

2.12.3.8.1 Qualified Employees

Only qualified workers who have been trained to work safely with test instruments and equipment on energized circuits shall^{2.50} be permitted to perform testing work on electrical circuits or equipment where there is danger of injury from accidental contact with energized parts or improper use of the test instruments and equipment.

2.12.3.8.2 Visual Inspections

Test instruments and equipment and all associated test leads, cables, power cords, probes, and connectors shall^{2.71} be visually inspected for external defects or damage before being used. If

there are defects or evidence of damage that might expose an employee to injury, the defective or damaged item shall^{2.71} not be used until replaced and tests have been made.

2.12.3.8.3 Rating Instruments and American National Standards Institute Equipment

Test instruments and equipment and their accessories shall^{2.72} be rated for the circuits and equipment to which they will be connected and shall^{2.73} be suitable for the environment in which they will be used.

2.12.3.8.4 Calibration of Electrical Instruments

ANSI Standard C39.1, *Requirements for Electric Analog Indicating Instruments*, defines the minimum performance and general requirements level for electrical instruments. ANSI standards also ensure that an instrument, when calibrated to National Institute of Standards and Technology traceable standards, is capable of transferring that quality of measurement to field conditions, within specified limits, when that level of measurement quality is needed.

A record should be maintained for each instrument, by serial number or equivalent method that shows: the dates of inspection; calibration data, as received; the date when it should be recalled from the field; and, a recalibration check made, and any interim repairs.

2.12.3.9 Work Near Overhead Lines

The work planning practices listed below should be used for: all work conducted near the limited approach boundary of electrical overhead lines; work inside underground electrical vaults; or, movement of any mechanical equipment near overhead lines. Work practices by qualified workers performed on electrical overhead lines should be applied using information contained in Section 8.0.

1. Work areas should be walked down by planners and workers to identify all electrical hazards during work planning.
2. Facility electrical maintenance or engineering organization, along with site electrical utilities should be involved in planning work in the vicinity of overhead electrical lines.
3. If it is possible to de-energize electrical overhead lines without causing a hazard greater than working near these lines, they should be de-energized prior to performing work.
4. Work performed near energized electrical lines should be controlled using a 2-barrier system, as described in item 6 below.
5. For work performed under high-voltage power lines (1 kV and higher), workers should be advised of potential static shock hazards, where a static charge may build up on conductive and non-conductive equipment and personnel (such as telephone wire, fences, and personnel who are working in an insulated bucket, ladder, or elevated platform).
6. All work near the limited approach boundary of overhead transmission and distribution lines, other than by electrical utility personnel, shall^{2.74} be performed in accordance with OSHA requirements. Two barriers should be incorporated to ensure no contact is made with energized overhead lines. Typical barriers include, but are not limited to:
 - a. The use of trained spotters that have direct communication with the operator.
 - b. Having electrical utility personnel measure line height to enable the spotter to accurately determine clearance distance.

- c. The installation of physical barriers to prevent encroachment into the limited approach boundary.
- d. The use of stakes or painted lines to provide constant reminders to operator and spotters of the proximity to overhead energized lines.
- e. The use of reflective materials to enhance visibility of overhead lines by spotters.
- f. The posting of signs indicating line height and clearance distance on common haul routes to warn of overhead energized electrical lines and enable the spotter to accurately determine clearance distance.
- g. Having electrical utility personnel rise or relocate overhead power lines to reduce possibility of inadvertent contact.
- h. The use of other control(s) that may be available and permitted provided they are effective.

2.12.4 Personal Protective Equipment

PPE is a last barrier for protecting the worker from hazards associated with the use or maintenance of electrical equipment and systems. It is a means for isolating the worker when establishing an electrically-safe work condition is not feasible or creates a greater hazard. See Section 2.11 for specific information regarding electrical PPE use and care.

PPE for electrical shock hazard shall^{2.74} be selected based on the results of a Shock Hazard Analysis required by NFPA 70E, 130.2(A). Arc flash PPE shall^{2.74} be selected based on the results of a Flash Hazard Analysis required by NFPA 70E, 130.3. Electrical workers should wear non-melting clothing, safety glasses, and leather gloves as minimum protection whenever working on or around energized electrical equipment.

2.12.5 Electrical Injuries

All electrical injuries (other than obvious static shocks) should be reported to supervision immediately. Electrical injuries may include thermal burns, arc burns, arc blast trauma, and electrical shocks. A medical professional should evaluate electrical injury victims as soon as possible.

3.0 Hazard Analysis

Paragraph 21 of 10 CFR 851, mandates "Contractors must establish procedures to identify existing and potential workplace hazards and assess the risk of associated worker injury and illness." Specific to electrical hazards, OSHA and NFPA 70E provide methods that electrical planners and workers use to develop processes to identify hazards in the workplace. Monthly performance metrics have shown that these methods appear to be effective since their implementation at DOE workplaces over the past several years. Recognizing that, in addition to standard industrial electrical hazards, many DOE workplaces have electrical hazards that may not be familiar to the general public or, in some cases; to all members of the organizations that develop consensus electrical codes and standards. Some DOE contractors have developed procedures that attempt to address these individual hazards and processes. Each site should incorporate a process based on the best interest of the site and workers.

4.0 ELECTRICAL PREVENTIVE MAINTENANCE

The term "electrical preventive maintenance" (EPM) refers to a program of regular inspection and service of equipment to detect potential problems and to take proper corrective measures.

4.1 DEVELOPMENT AND IMPLEMENTATION REQUIREMENTS

An EPM program should be developed and implemented based on the requirements of:

1. DOE O 433.1, *Maintenance Management Program for DOE Nuclear Facilities*
2. NFPA 70B, *Recommended Practice for Electrical Equipment Maintenance*
3. NFPA 70E, *Standard for Electrical Safety in the Workplace*
4. NFPA 72, *National Fire Alarm Code*
5. *ANSI/NETA MTS, National Electrical Testing Association, Standard for Maintenance Testing Specifications*
6. IEEE/ANSI-C2, *National Electrical Safety Code*

4.2 ELECTRICAL PREVENTIVE MAINTENANCE PROGRAM

An EPM program is defined as a managed program of inspecting, testing, analyzing, and servicing electrical systems and equipment with the purpose of maintaining safe operations and production by reducing or eliminating system interruptions and equipment breakdowns.

This system manages the conduct of routine inspections and tests and the servicing of electrical equipment so that impending troubles can be detected and reduced or eliminated. When designers, installers, or constructors specify, install, and construct equipment with optional auxiliary equipment, that optional equipment should be part of the EPM program. Records of all inspections, tests, and servicing should be documented and reviewed.

All electrical equipment that is appropriate for EPM should be inspected, tested, and serviced in accordance with an EPM program.

Inspections, tests, and servicing shall^{4.1} be performed by personnel who are qualified for the work to be performed. These qualifications can be shown by appropriate documentation of work experience, on-the-job training, as well as offsite formal training to verify understanding and retention of minimum knowledge, skills, and abilities.

4.3 MAINTENANCE

Electrical equipment should be maintained in accordance with the manufacturer's recommendations and instructions for the local operating environment. A copy of the manufacturer's recommendations should be documented and on file.

4.4 INSPECTION

If an EPM program does not exist, an inspection, testing, and servicing program should be developed and implemented to establish a baseline to initiate an EPM program. The inspection frequency should be as recommended by the manufacturer or as otherwise indicated in NFPA 70B. An initial period of inspection (sometimes several years) provides sufficient knowledge

that, when accumulated, may permit increasing or decreasing that interval, based upon documented observations and experience.

4.5 ESSENTIAL ELEMENTS

The EPM program should include the essential elements described in NFPA 70B, Chapter 5, *What is an Effective EPM Program?* This includes planning, identifying the main parts, and utilizing available support services for a program. For example, an EPM program should include the following essential ingredients:

1. Responsible and qualified personnel;
2. A survey and an analysis of electrical equipment and systems to determine maintenance requirements and priorities;
3. Programmed routine inspections and suitable tests;
4. Accurate analysis of inspection and test reports so that proper corrective measures can be prescribed;
5. Performance of necessary work; and
6. Concise, but complete, records.

4.6 PLANNING AND DEVELOPING AN EPM PROGRAM, AND FUNDAMENTALS OF EPM

The EPM program should be planned and developed to include each of the functions, requirements, and economic considerations described in NFPA 70B, Chapter 6, *Planning and Developing an EPM Program*, and NFPA 70B, Chapter 8, *Fundamentals of EPM*. Chapter 6 includes: surveying the existing electrical system installation; identifying crucial equipment; establishing a systematic program to follow; and, developing methods and procedures to plan, analyze, and record maintenance activities.

Electrical drawings should be kept current. A system of recording changes in electrical systems and then integrating those changes into the applicable drawings should be developed and implemented.

NFPA 70B includes designing to accommodate maintenance, scheduling maintenance, personnel and equipment safety, circuit protection, and initial acceptance testing.

4.7 GROUND FAULT PROTECTION AND ARC FAULT CIRCUIT INTERRUPTERS

The EPM program should include the essential ingredients of Chapter 15 of NFPA 70B, *Ground Fault Protection*. This includes ground fault circuit interrupters (GFCIs) and ground fault protection for equipment (GFPE). Ground fault protective devices are intended to protect personnel and equipment. There are two distinct types: the GFCI and the GFPE. It is extremely important to understand the difference between them. A Class A GFCI trips when the current to ground has a value in the range of 4 through 6 milliamperes (mA) and is used for personnel protection. A Class B GFCI (commonly used as ground fault protection for equipment) trips when the current to ground exceeds 20 mA. A Class B GFCI is not suitable for employee protection.

A GFCI is defined in Article 100 of the NEC as a device intended for the protection of personnel that functions to de-energize a circuit, or portion thereof, within an established period of time, when a current to ground exceeds a set value.

4.7.1 Ground Fault Circuit Interrupters (GFCIs)

Ground fault circuit protection should be permitted to be used in any location, circuit, or occupancy to provide additional protection from line-to-ground shock hazards because of the use of electric hand tools. Where GFCI protection is not permanently installed, portable GFCI protection is acceptable.

4.7.1.1 How a GFCI Works

GFCIs are devices that sense when current—even a small amount—passes to ground through any path other than the proper conductor. When this condition exists, the GFCI quickly opens the circuit, stopping all current flow to the circuit and to a person receiving the ground fault. Figure 4-1 shows a typical circuit arrangement of a GFCI designed to protect personnel. The incoming two-wire circuit is connected to a two-pole, shunt-trip overload circuit breaker.

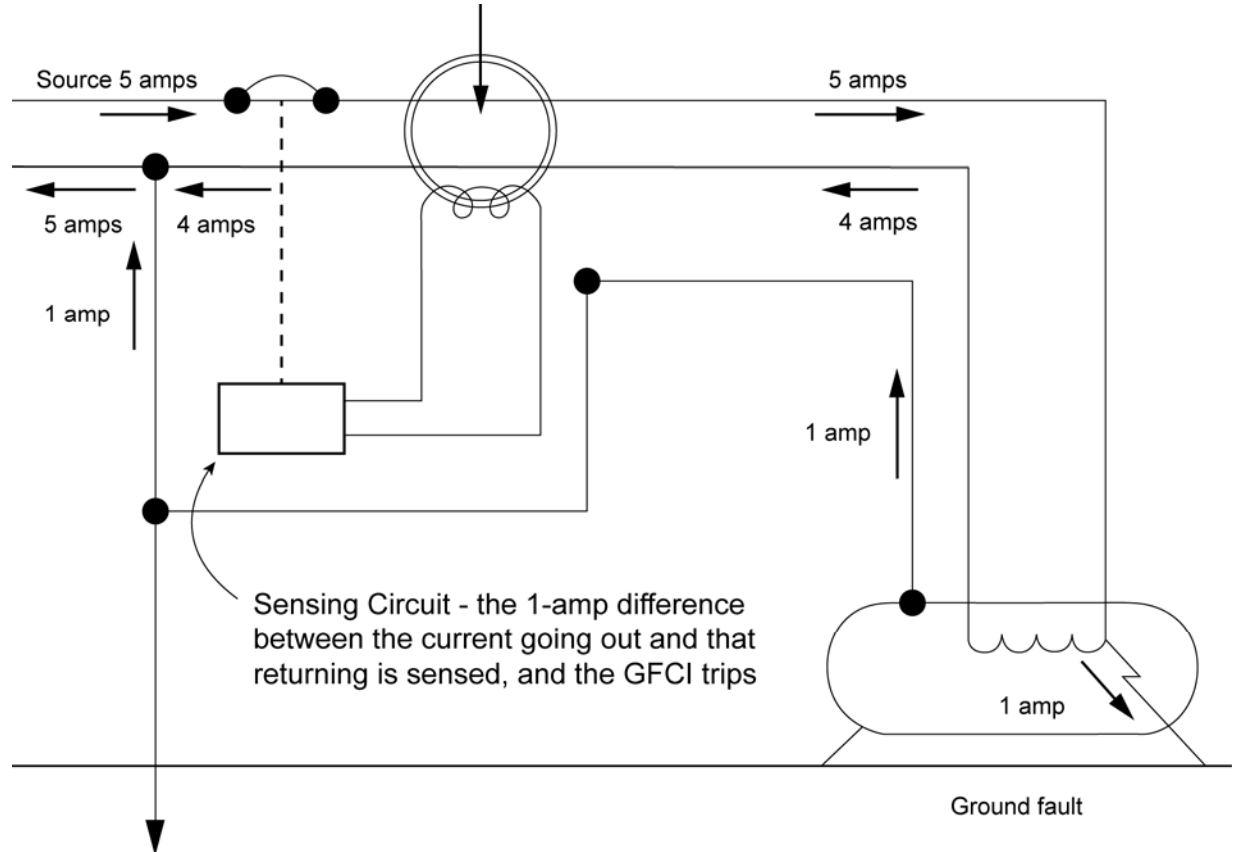

OSHA Section 29 CFR 1910.304(b)(1)

Fig. 4-1. Principle of GFCI operation.

The load-side conductors pass through a differential coil onto the outgoing circuit. As long as the current in both load wires is within specified tolerances, the circuit functions normally. If one of the conductors comes in contact with a grounded condition or passes through a person's body to ground, an unbalanced current is established. The differential transformer picks up this unbalanced current, and a current is established through the sensing circuit to energize the shunt trip of the overload circuit breaker and quickly open the main circuit. A fuse or circuit breaker cannot provide this kind of protection. The fuse or circuit breaker trips or opens the circuit only if a line-to-line or line-to-ground fault occurs that is greater than the circuit protection device rating.

Differential transformers continuously monitor circuits to ensure that all current that flows out to motor or appliances returns to the source via the circuit conductors. If any current leaks to a fault, the sensing circuit opens the circuit breaker and stops all current flow.

A GFCI does not protect the user from line-to-line or line-to-neutral contact hazards. For example, if an employee using a double-insulated drill with a metal chuck and drill bit protected by a GFCI device drills into an energized conductor and contacts the metal chuck or drill bit, the GFCI device does not trip (unless it is the circuit the GFCI device is connected to) as it does not detect a current imbalance.

4.7.1.2 Uses of GFCIs

The use of GFCIs in branch circuits for other than dwelling units is defined in NFPA 70.

Ground fault protection for personnel or an assured equipment grounding program shall^{4.2} be used for temporary wiring installations utilized to supply temporary power to equipment used by personnel during construction, remodeling, maintenance, repair, or demolition activities.

For temporary wiring installations:

1. All 120-V, single-phase, 15-, 20-, and 30-A receptacle outlets that are not a part of the permanent wiring of the building or structure, and that are in use by employees, shall^{4.3} have GFCI protection for personnel.
2. GFCI protection, or an assured equipment grounding program (see Section 5.0) for all other receptacles, shall^{4.4} be used to protect against electrical shocks and hazards.
3. GFCIs shall^{4.5} be tested according to the manufacturer's instructions.

4.7.2 Arc Fault Circuit Interrupters (AFCIs)

A technique for reducing the risk of arc-generated fires is the use of the arc fault current interrupter (AFCI). An AFCI is a device intended to provide protection from the effects of arc faults by recognizing characteristics unique to arcing and by functioning to de-energize the circuit when an arc fault is detected. AFCIs are evaluated to UL1699, *Safety Standard for Arc-Fault Circuit Interrupters*, using testing methods that create or simulate arcing conditions to determine the product's ability to detect and interrupt arcing faults.

Although the NEC requires that AFCI protection be provided on branch circuits that supply outlets (receptacle, lighting, etc.) in dwelling units, there is no prohibition against providing AFCI protection on other circuits or locations.

4.7.3 Ground Fault Protection for Equipment (GFPE)

A GFPE is defined in Article 100 of the NEC as a system intended to provide protection of equipment from damaging line-to-ground fault currents. GFPE systems (equipped with or without a test panel) shall^{4,6} be inspected and tested at installation and at specified intervals, as recommended by the manufacturer.

Figure 4-2 shows a zero-sequence type of ground fault protection. Ground fault protection shall^{4,7} be provided with 277/480-V, three-phase, four-wire services with overcurrent protective devices (OCPDs) of 1,000 amperes (A) or more. A ground fault sensor (window) can be used to encircle all service conductors, including the grounded conductor (neutral).

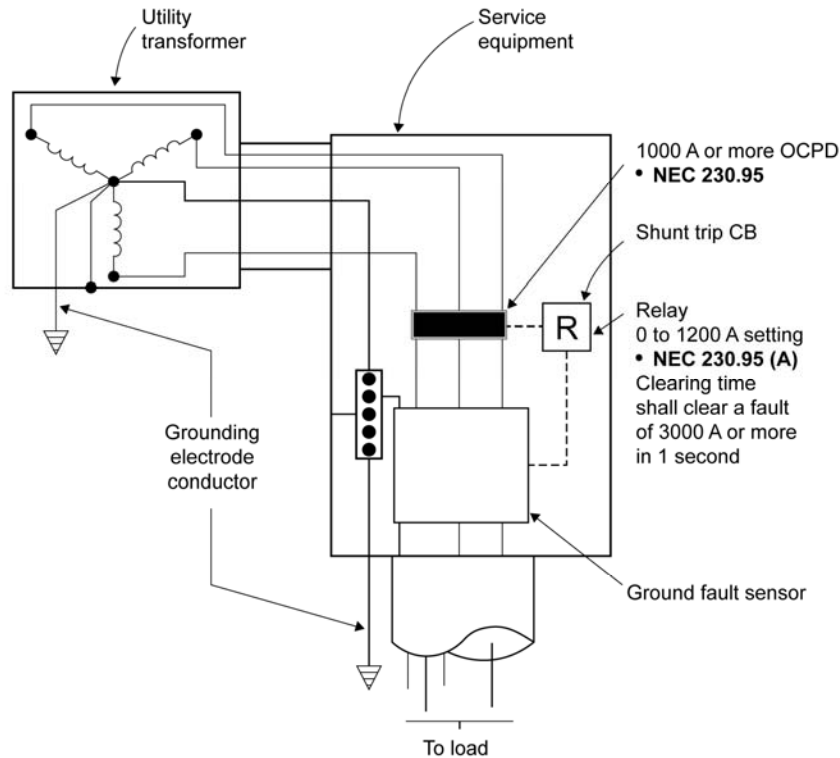

Fig. 4-2. Example of ground fault protection of equipment.

4.8 OVERCURRENT PROTECTIVE DEVICES

Devices, such as fuses and circuit breakers that interrupt current flow through the circuit provide a critical safety function. These circuit elements protect conductor insulation in downstream equipment by limiting the time high currents can flow through the circuit and protect property from fire hazards by interrupting current under overload conditions. These devices may also result in protecting the worker from serious injury. To ensure these protective devices perform effectively, overcurrent protective devices shall^{4,8} be maintained in accordance with the manufacturers' instructions or industry consensus standards.

5.0 GROUNDING

This section presents general rules for the grounding and bonding of electrical installations. Qualified workers should clearly understand the concepts of grounding practices as required by the NEC. They should also clearly understand the definition and intent of the following components of a grounding system that are explained in this section:

1. Grounded conductor
2. Grounding conductor
3. Grounding electrode conductor (GEC)
4. Bonding jumper
5. Grounding electrode

5.1 SPECIFICATIONS AND DRAWINGS

Engineering specifications and drawings should identify the requirements for all components and clearly illustrate the grounding electrode system, the GEC, bonding points and bonding jumpers and the connection point for the grounded conductor, as well as the grounding conductors. When used for installation or construction purposes, these specifications and drawings should also include detailed installation instructions.

5.2 CIRCUIT AND SYSTEM GROUNDING

Circuit and system grounding consists of connecting the grounded conductor, the equipment grounding conductor (EGC), the grounding bus bars, and all noncurrent-carrying metal parts to ground. This shall^{5.1} be accomplished by connecting a properly sized continuous GEC between the grounded bus and the grounding electrode system. There are three fundamental purposes for grounding and bonding an electrical system and equipment:

1. To limit excessive voltage from lightning, line surges, and crossovers with higher voltage lines;
2. To keep conductor enclosures and noncurrent-carrying metal enclosures and equipment at zero potential to ground; and
3. To facilitate the opening of OCPDs in case of insulation failures because of faults, short circuits, etc.

5.3 EQUIPMENT GROUNDING

Equipment grounding systems, which consist of interconnected networks of EGCs, are used to perform the following functions:

1. Limit the hazard to personnel (shock voltage) from the noncurrent-carrying metal parts of equipment raceways and other conductor enclosures in case of ground faults; and
2. Safely conduct ground-fault current at sufficient magnitude for fast operation of the circuit OCPD.

To ensure the performance of the above functions, EGCs shall^{5.2,5.3,5.4}:

1. Be permanent and continuous;
2. Have ample capacity to safely conduct ground-fault current likely to be imposed on them; and
3. Have impedance sufficiently low to limit the voltage to ground to a safe magnitude and to facilitate the operation of the circuit overcurrent protection devices.

5.4 BONDING

Caution shall^{5.5} be taken to ensure that the main bonding jumper and equipment bonding jumper are sized and selected correctly. Bonding completes the grounding circuit so that it is continuous. If a ground fault occurs, the fault current flows and opens the OCPDs. The means of bonding shall^{5.5} provide the following to ensure the grounding system is intact:

1. Provide a permanent connection;
2. Provide positive continuity at all times; and
3. Provide ampacity to conduct fault current.

See Fig. 5-1 which depicts the proper grounding of electrical systems. Circuit and system grounding consists of earth grounding the electrical system at the supply transformer and the line side of the service equipment. Equipment grounding and bonding is accomplished by connecting all metal enclosures and raceways together with the grounding conductors.

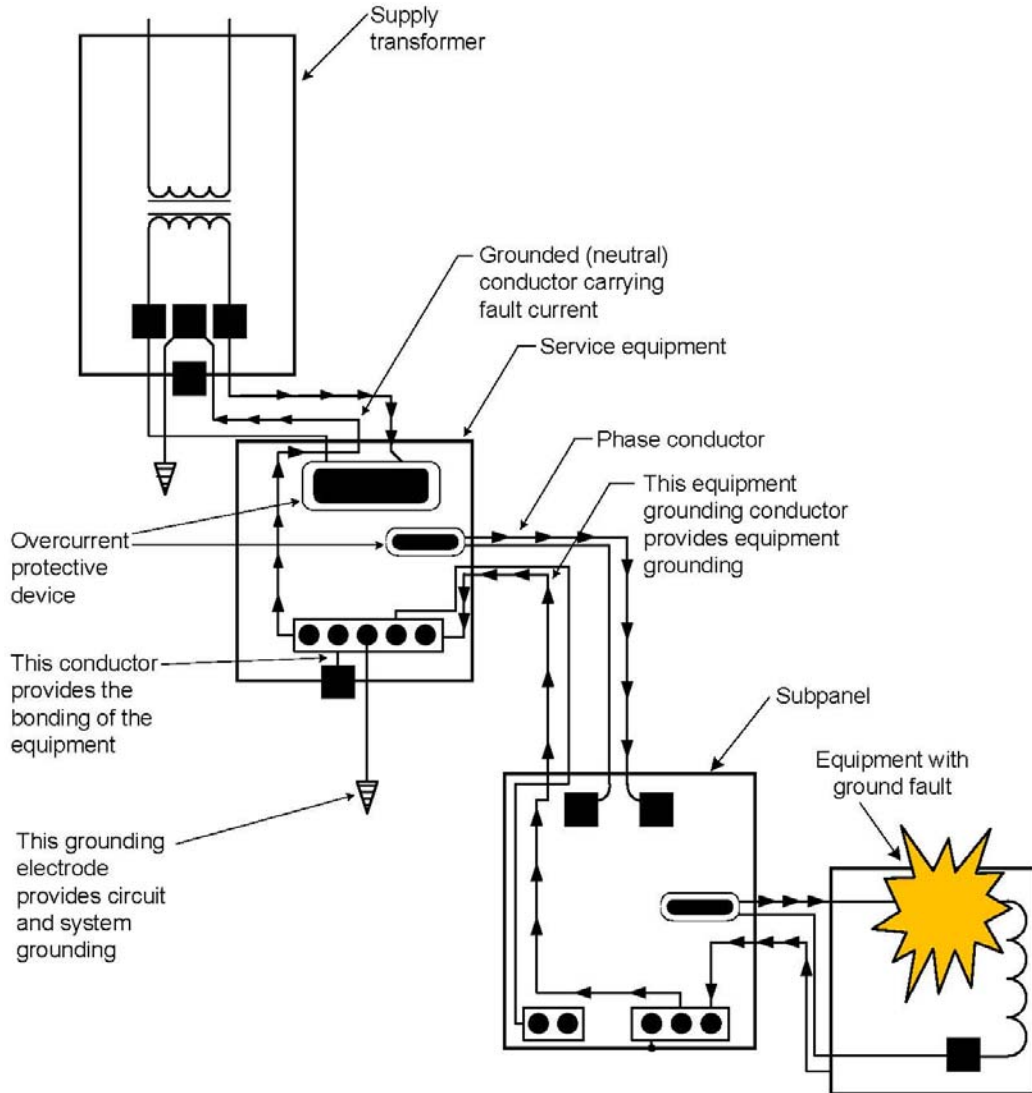

NEC 250.4

Fig. 5-1. System grounding in a typical facility.

5.5 GROUNDED OR UNGROUNDED SYSTEMS

Ungrounded systems may provide greater continuity of operations in the event of a fault. However, the second fault can most likely be more catastrophic than a grounded system fault. Whenever ungrounded systems are used in a facility, the maintenance personnel shall^{5,6} receive training in how to detect and troubleshoot the first fault on an ungrounded system.

"Grounded" means that the connection to ground between an electrical system conductor and earth has been made. Ungrounded electrical systems are used where the designer does not want the OCPD to clear in the event of a ground fault. The noncurrent-carrying metallic parts of an ungrounded electrical system shall^{5,7} be grounded.

Ground detectors shall^{5.8} be installed on ungrounded systems per the NEC to sound an alarm or send a message to alert personnel that a first fault has occurred on one of the phase conductors. Ground detectors detect the presence of leakage current or developing fault current conditions while the system is still energized and operating. By warning of the need to take corrective action before a problem occurs, safe conditions can usually be maintained until an orderly shutdown is implemented.

5.5.1 Grounded Systems

Grounded systems are equipped with a grounded conductor that is required^{5.9} to be run to each service disconnecting means for equipment operating at less than 1000 VAC. The grounded conductor can be used as a current-carrying conductor to accommodate all neutral-related loads. It can also be used to provide an effective ground fault current path on the supply side of the service disconnecting means to clear ground faults.

A network of EGCs is routed from the service equipment enclosure to all metal enclosures throughout the electrical system. The EGC carries fault currents from the point of the fault to the grounded bus in the service equipment where it is transferred to the grounded conductor. The grounded conductor carries the fault current back to the source and returns over the faulted phase and trips open the OCPD.

Note: A system is considered grounded if the supplying source, such as a transformer or generator, is grounded in addition to the grounding means on the supply side of the service equipment disconnecting device for separately derived systems.

The neutral of any grounded system serves two main purposes: (1) it permits the utilization of line-to-neutral voltage and, thus, serves as a current-carrying conductor; and, (2) it plays a vital role in providing a low-impedance path for the flow of fault currents to facilitate the operation of the overcurrent devices in the circuit (see Fig. 5-2). Consideration shall^{5.10} be given to the sizing of the neutral conductor for certain loads due to the presence of harmonic currents.

**NEC 250.130**

Fig. 5-2. A typical grounded system from a utility service.

5.5.2 Ungrounded Systems

Ungrounded systems operate without a grounded conductor. In other words, none of the circuit conductors of the electrical system are intentionally grounded to an earth ground, such as a metal water pipe, or building steel. The noncurrent-carrying conductive materials of an ungrounded electrical system shall^{5.7} be grounded. The same network of EGCs is provided for ungrounded systems as that for solidly grounded electrical systems. However, EGCs are used only to locate phase-to-ground faults and sound some type of alarm. Therefore, a single sustained line-to-ground fault does not result in an automatic trip of the OCPD. This is a major benefit if electrical system reliability is required, or if it would result in the shutdown of a continuous process. However, if an accidental ground fault occurs and is allowed to flow for a substantial time, overvoltage can develop in the associated phase conductors. Such an overvoltage situation can lead to conductor insulation damage, and while a ground fault remains on one phase of an ungrounded system, personnel contacting one of the other phases and ground are subjected up to 1.732 times the voltage they would experience on a solidly grounded neutral system. (See Fig. 5-3.)

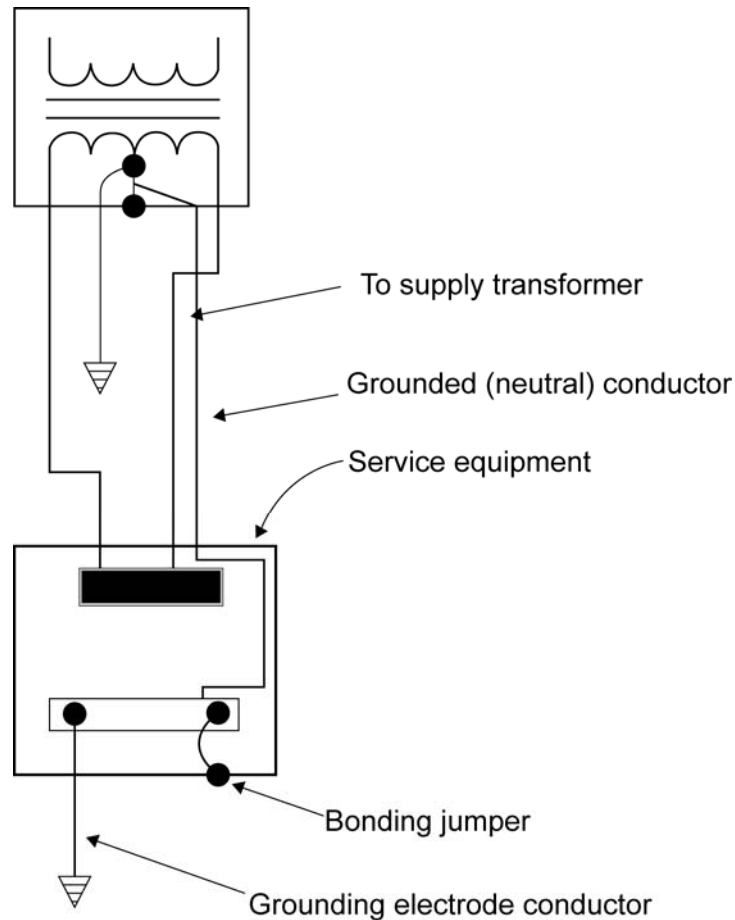
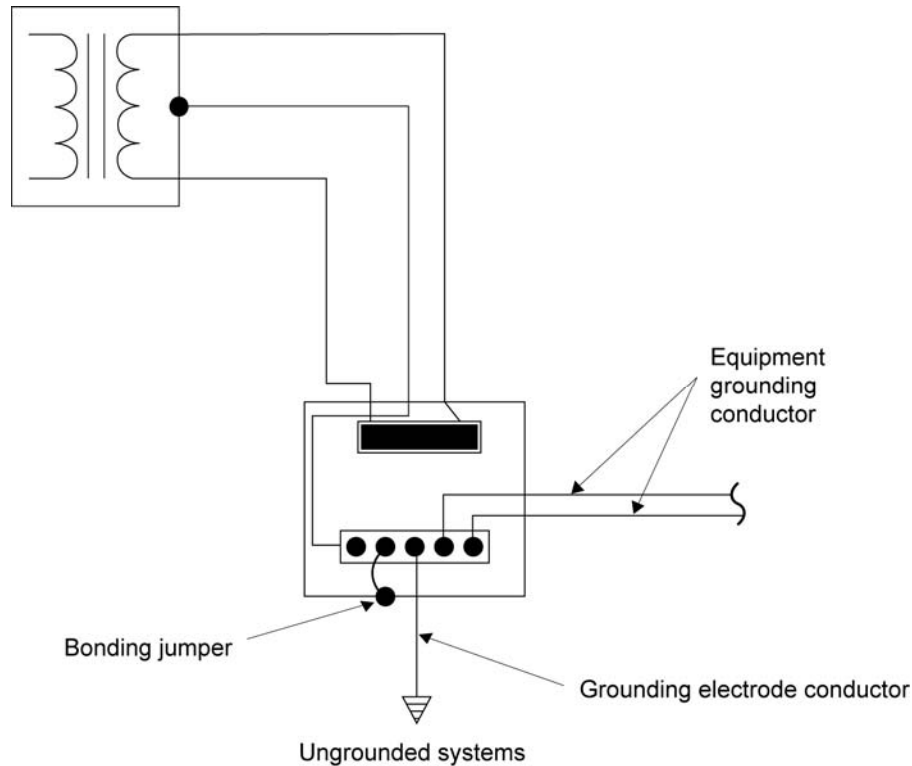
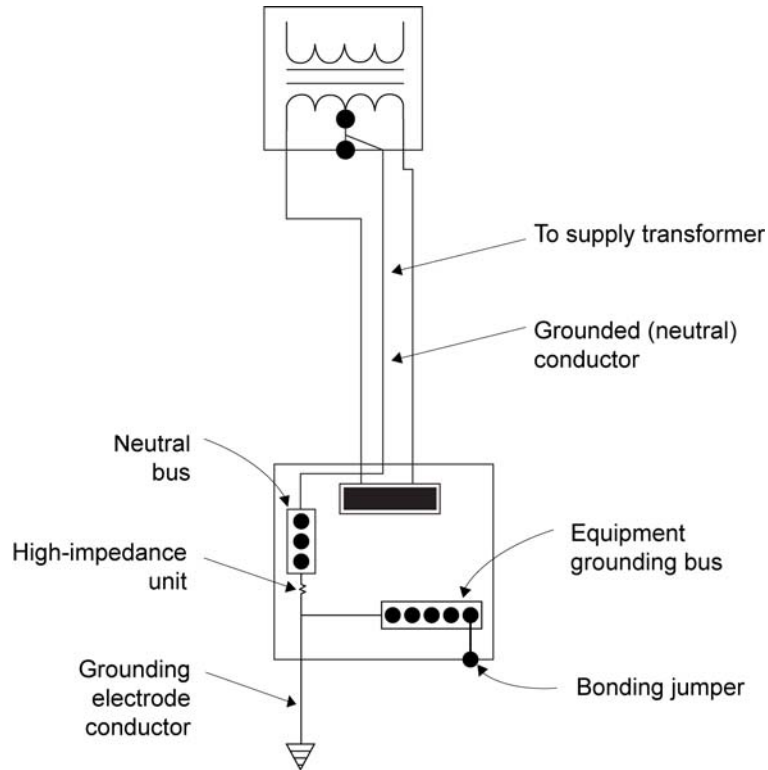

Fig. 5-3. An ungrounded system.

Note: Ungrounded systems, 120 – 1000 V AC, shall^{5.8} be equipped with ground detectors and proper maintenance applied to avoid, to the extent practical, the overcurrent of a sustained ground fault on ungrounded systems. If appropriate maintenance is not provided for ungrounded systems, a grounded system should be installed to ensure that ground faults are cleared and circuits, equipment, and personnel are safe.

5.5.3 High-Impedance Grounding

Electrical systems containing three-phase, three-wire loads, as compared to grounded neutral circuit conductor loads, can be equipped with a high-impedance grounded system. High-impedance grounded systems shall^{5.11} not be used unless they are provided with ground fault indicators or alarms, or both, and unless qualified personnel are available to quickly locate and eliminate such ground faults. Ground faults should be promptly removed or the service reliability could be reduced. See the NEC for requirements on installing a high-impedance grounding system. (See Fig. 5-4.)



NEC 250.36

Fig. 5-4. A high-impedance grounding system.

5.6 GROUNDING REQUIREMENTS

Alternating current systems of less than 50 V shall^{5.12} be grounded. Systems of 50 to 1,000 V shall^{5.13} be solidly grounded. Systems supplying phase-to-neutral loads shall^{5.11} be solidly grounded (see Fig. 5-5). Solidly grounded means^{5.14} connected to the earth without inserting any resistance or impedance. The following electrical systems shall^{5.13} be solidly grounded:

1. 240/120-V, single-phase, three-wire;
2. 208Y/120-V, three-phase, four-wire where there are line-to-neutral loads;
3. 480Y/277-V, three-phase, four-wire where there are line-to-neutral loads; and
4. 240/120-V, three-phase, four-wire, delta (midpoint of one phase used as a grounded circuit conductor).

Transformer secondary

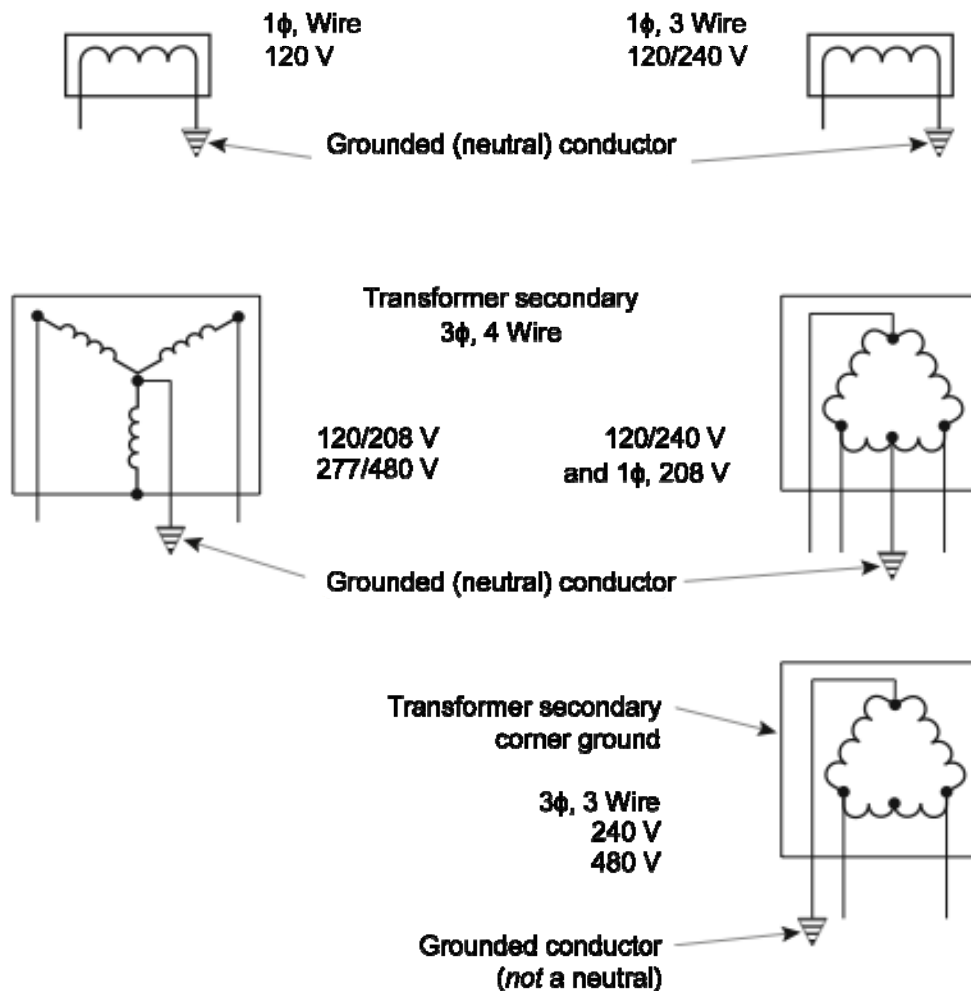

Fig. 5-5. Grounding for systems of 50 to 1,000 V AC.

If the following systems are not solidly grounded they shall^{5,13,5,15} have ground detectors installed:

1. 240-V, three-phase, three-wire delta;
2. 480-V, three-phase, three-wire;
3. 600-V, three-phase, three-wire; and
4. 480-V, three-phase, four-wire where the neutral is not used as a circuit conductor.

These electrical systems do not supply phase-to-neutral loads. They supply only phase-to-phase loads.

5.7 GROUNDING ELECTRODE CONDUCTOR (GEC)

The purpose of the GEC is to connect the electrical system to earth ground.

In grounded systems, the GEC connects to the neutral bar in the service equipment enclosure. In ungrounded systems, the GEC connects to the grounding terminal bar. It grounds the

following items to the grounding electrode system and provides a common reference between earth and:

1. The grounded conductor, if present.
2. The equipment grounding conductor, if present.
3. The metal of conduits, if present.
4. The metal of enclosures, if present.
5. The bonding jumpers bonding together metal enclosures and conduits.
6. The metal enclosure of the service equipment.

5.7.1 Sizing the Grounding Electrode Conductor

NEC 250.66 requires the GEC to be sized by the circular mils rating of the largest service entrance conductor or conductors and selected from NEC Table 250.66 based on these values.

5.7.2 Exceptions to NEC 250.66

There is an exception to the main rule. It has three parts and pertains to specific types of grounding electrodes. The exception applies to grounded and ungrounded systems.

Exception (A) applies to made electrodes only, such as rod, pipe, or plate electrodes. The GEC is not required to be larger than #6 copper or #4 aluminum.

Exception (B) to NEC 250.66 permits a copper conductor not greater than #4 American Wire Gauge (AWG) to be used as a GEC to ground the electrical system to a concrete-encased electrode.

Exception (C) permits a conductor not larger than the ground ring size to be used as a GEC when the electrode is a ground ring.

5.8 MAIN BONDING JUMPER

The function of the main bonding jumper is to connect the grounded circuit conductor and the EGC at the service equipment. If the main bonding jumper is left out, there may be no low-impedance circuit for fault current, which poses a potentially dangerous situation.

The main bonding jumper shall^{5.16} connect together the following items within the enclosure for each service disconnect:

1. System grounded conductor;
2. EGCs; and
3. Service disconnect enclosure.

If supplied, the manufacturer's main bonding jumper is the preferred conductor to be used as the main bonding jumper. The NEC requires^{5.16} the main bonding jumper to be a: (1) wire, (2) screw, (3) bus bar, or (4) a similar suitable conductor. If the bonding jumper is a screw only, it shall^{5.17} be identified with a green finish that shall^{5.17} be visible with the screw installed.

The NEC requires^{5.16} the main bonding jumper to be at least the same size as the GEC when the circular mils rating of the service entrance conductors does not exceed 1100 thousand

circular mils (KCMil) for copper or 1750 KCMil for aluminum. For phase conductors greater than 1100 KCMil copper or 1750 KCMil aluminum, the size of the main bonding jumper shall^{5.18} be not less than 12.5% of the largest phase conductor.

5.9 SYSTEM WITH GROUNDED CONDUCTOR

The main purpose of the grounded conductor is to carry unbalanced neutral current under normal operating conditions or fault current in the event that one phase should go to ground.

Note: The grounded conductor does not always have to be a neutral conductor. It can be a phase conductor, as when used in a corner grounded delta system. NEC Article 200 provides specific requirements for the use and identification of grounded conductors.

In solidly grounded service-supplied systems, the EGS shall^{5.19} be bonded to the system-grounded conductor and the GEC at the service equipment. The grounded conductor may be used to ground the noncurrent-carrying metal parts of equipment on the supply side of the service disconnecting means per NEC 250.142. The grounded conductor can also serve as the ground fault current return path from the service equipment to the transformer that supplies the service.

Generally, the grounded conductor shall^{5.20} not be used to ground the metal parts of enclosures enclosing conductors and components on the load side of the service. The grounded conductor shall^{5.21} be connected as follows:

1. The GEC shall^{5.22} be connected to the grounded (neutral) service conductor.
2. The connection shall^{5.16} be at an accessible point. The accessible point can be anywhere from the load end of the service drop or service lateral to, and including, the neutral bar in the service disconnecting means or service switchboard.

Fig. 5-6 illustrates the use of the grounded conductor. The grounded (neutral) conductor is used to carry normal neutral current or ground fault current in case a ground fault should develop on one of the ungrounded (hot) phase conductors.

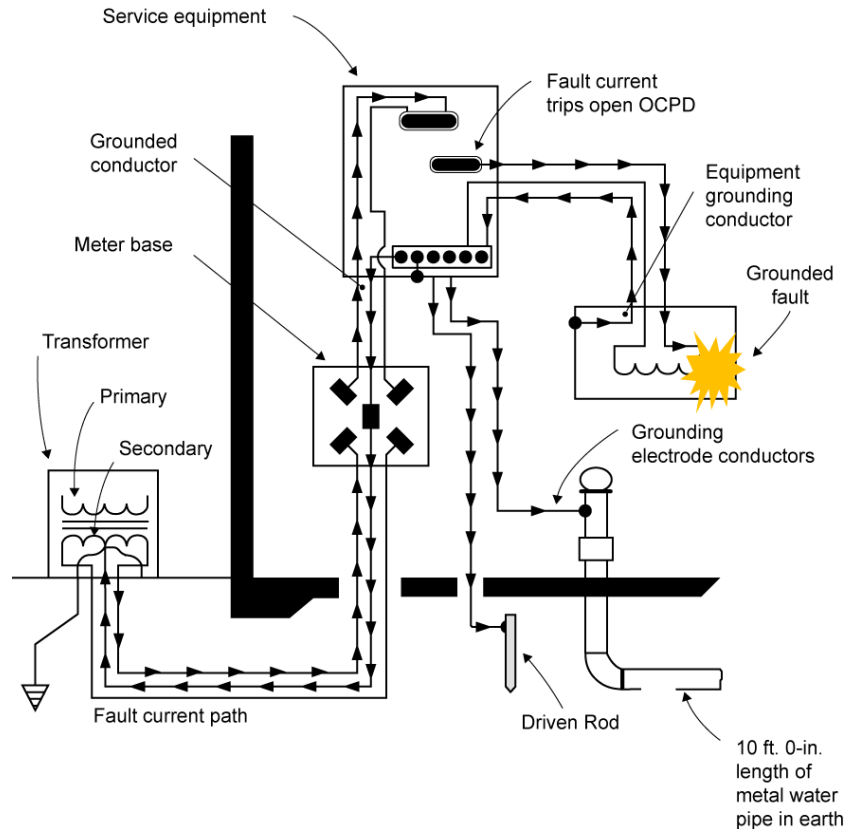

Fig. 5-6. The grounded neutral conductor.

NEC 250.24 lists the rules for sizing the grounded conductor where it is not used as a grounded neutral circuit conductor. NEC 220.61 gives the rules for calculating and sizing the grounded conductor, when it is used as a circuit conductor. The minimum size for the grounded conductor is the larger of the load calculated by NEC 220.61, or computed as follows:

1. The basic rule is to select the size directly from NEC Table 250.66 when the size of the service-entrance conductors is not larger than 1100 KCMil copper or 1750 KCMil aluminum.
2. When the service entrance conductors are larger than 1100 KCMil copper or 1750 KCMil aluminum, the grounded conductor shall^{5.16} be 12.5% of the largest phase conductor.
3. When the service phase conductors are paralleled, the size of the grounded conductor shall^{5.23} be based on the total cross-sectional area of the phase conductors. When installed in two or more raceways, the size of the grounded conductor should be based on the phase conductors, but not smaller than 1/0.

5.10 EQUIPMENT GROUNDING CONDUCTOR

EGCs for AC systems, where used, shall^{5.24} be run with the conductors of each circuit per NEC 300.3, 250.102 (E) and 250.134.

Earth and the structural metal frame of a building shall^{5.25} not be used as the sole EGC for AC systems.

5.10.1 Sizing the Equipment Grounding Conductor

NEC 250.122 lists the requirements for calculating the size of the EGCs in an electrical circuit. There are basically five steps to be applied in sizing, selecting, and routing the EGCs:

1. NEC Table 250.122 shall^{5.26} be used to size the EGC.
2. When conductors are run in parallel in more than one raceway, the EGC is also run in parallel. Each parallel EGC shall^{5.27} be sized based on the ampere rating of the overcurrent device protecting the circuit conductors.
3. When more than one circuit is installed in a single raceway, one EGC may be installed in the raceway. However, it shall^{5.28} be sized for the largest overcurrent device protecting conductors in the raceway.
4. When conductors are adjusted in size to compensate for voltage drop, the EGC shall^{5.29} also be adjusted in size.
5. The EGC shall^{5.30} not be required to be larger than the feeder tap conductors.

5.10.2 Separate Equipment Grounding Conductors

The possibility of worker exposure to electric shock can be reduced by the use of separate EGCs within raceways.

Ground fault current flows through every available path inversely proportional to the impedance of the path. The metallic raceway enclosing the conductors may provide the lowest impedance path sufficient to permit the overcurrent device to operate in a timely manner. However, fittings and raceway systems have been found that are not tightly connected or are corroded and may cause the raceway to present a high impedance path. Therefore, the separate EGC is an assured path for the fault current to travel over and clear the OCPD protecting the circuit.

NEC 250.134(B) requires the EGCs to be routed in the same raceway, cable, cord, etc., as the circuit conductors. All raceway systems should be supplemented with separate EGCs.

Note: The EGC, where used, shall^{5.31} be routed with supply conductors back to the source. Additional equipment grounding may be made to nearby grounded structural members or to grounding grids, but this shall^{5.32} not take the place of the co-routed EGCs. Raceway systems should not be used as the sole grounding conductor.

5.11 UNGROUNDED SYSTEMS

Three-phase, three-wire, ungrounded systems (delta), which are extensively used in industrial establishments, shall^{5.15} not require the use of grounded conductors as circuit conductors.

The same network of EGCs shall^{5.33} be provided for ungrounded systems as those for grounded systems. EGCs in ungrounded systems shall^{5.34} provide shock protection and present a low-impedance path for phase-to-phase fault currents in case the first ground fault is not located and cleared before another ground fault occurs on a different phase in the system.

GECs and bonding jumpers shall^{5.35} be computed, sized, and installed in the same manner as if the system were a grounded system. Apply all the requirements listed in Section 5.7 for sizing the elements of an ungrounded system.

5.12 GROUNDING A SEPARATELY DERIVED SYSTEM

NEC 250.30 covers the rules for grounding separately derived systems. The system grounded conductor for a separately derived system shall^{5.36} be grounded at only one point. That single system grounding point is at any point from the source of the separately derived system to the first system disconnecting means or overcurrent device. When there is no main system disconnecting means, the connection shall^{5.36} be made at the source of the system.

The grounding electrode for a separately derived system is the nearest of either an effectively grounded structural metal member of the building or an effectively grounded water pipe. If neither is available, concrete-encased electrodes or made electrodes are permitted.

In a grounded, separately derived system, the EGCs shall^{5.36} be bonded to the system-grounded conductor and to the grounding electrode at, or ahead of, the main system disconnecting means or OCPD. The EGC shall^{5.37} always be bonded to the enclosure of the supply transformer, generator, or converter.

The GEC, the system bonding jumper, the grounded conductor, and the EGC are calculated, sized, and selected by the rules listed in Sections 5.7 through 5.10 (see Fig. 5-7). The grounded (neutral) conductor can be used to carry both normal neutral current and abnormal ground fault current.

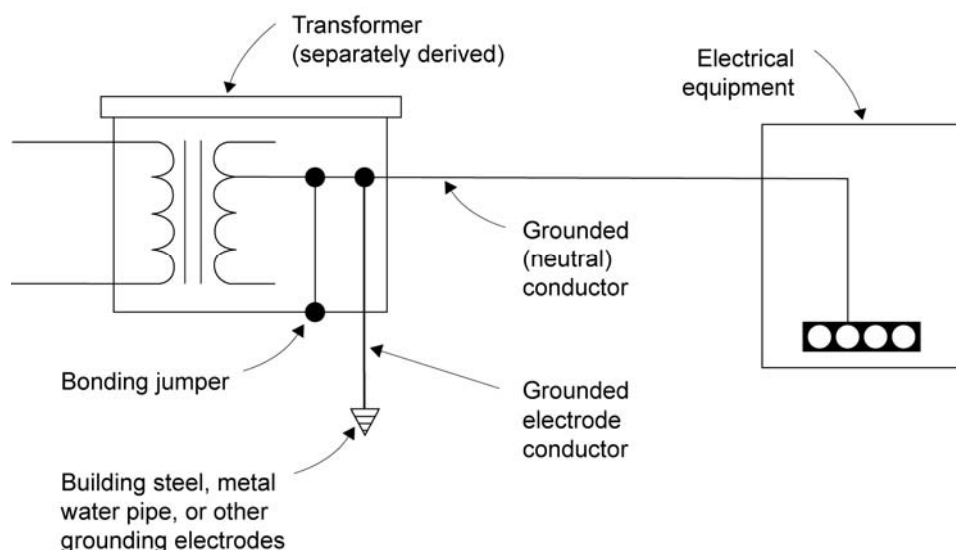

Fig. 5-7. The grounded conductor.

5.13 GROUNDING ELECTRODE SYSTEM

NEC 250.52 lists types of electrodes. If one or more are available, they shall^{5.38} be bonded together to make up the grounding electrode system. The bonding jumper that connects these electrodes shall^{5.39} be at least as large as the GEC of the system sized by NEC 250.66. The types of electrodes are as follows:

1. A metal water pipe in contact with the earth for 10 feet or more. An interior metal water pipe beyond 5 feet from the point of building entrance shall^{5.40} not be used as a part of

the grounding electrode system or, as a conductor to interconnect those electrodes, unless the entire length used as an electrode is exposed.

2. A metal frame of the building or structure, where effectively grounded.^{5.41}
3. A bare #4 conductor at least 20 feet in length and near the bottom of the concrete foundation (within 2 inches), or ½ inch minimum reinforcing steel or rods at least 20 feet in length (one continuous length or spliced together using usual steel tie wires).^{5.42}
4. A bare #2 conductor encircling building at least 20 feet in length and 2.5 feet in the ground.^{5.43}
5. Rod and pipe electrodes at least 8 feet in length.^{5.44}
6. A plate electrode that exposes at least 2 square feet of surface to exterior soil.^{5.45}
7. Other local metal underground systems or structures that are not effectively bonded to a metal water pipe.^{5.46}

The GEC at the service equipment shall^{5.47} be permitted to be connected to any convenient interbonded electrodes that provide a solid, effective connection where the other electrode(s), if any are properly connected together. (See Fig. 5-8, which illustrates some of the different types of grounding electrodes.)

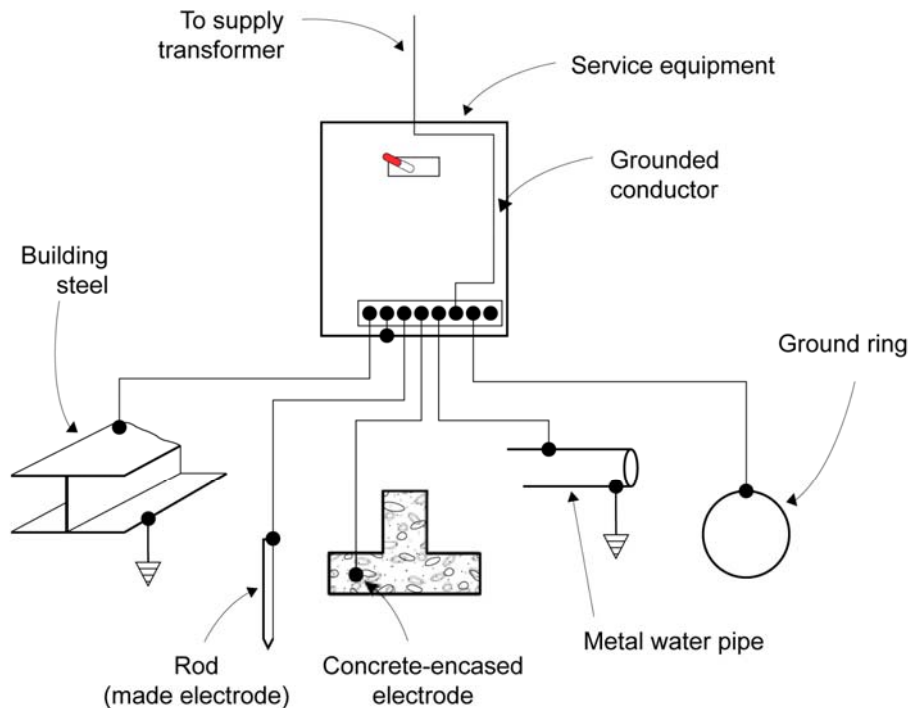

Fig. 5-8. Types of grounding electrodes.

5.14 PERSONNEL PROTECTIVE GROUNDS

Personnel working on, or near, de-energized lines or conductors in electrical equipment shall^{5.48} be protected against shock hazard and flash burns that could occur if the circuit was inadvertently re-energized. Properly installed equipotential protective grounds can aid in lessening the risk of exposure to such hazards by providing additional protection to personnel while they service, repair, and work on such systems.

5.14.1 Purpose of Personnel Protective Grounds

Personnel protective grounds are applied to de-energized circuits to provide a low-impedance path to ground should the circuits become re-energized while personnel are working on or near conductive parts. In addition, the personnel protective grounds provide a means of draining off static and induced voltage from other sources while work is being performed on a circuit (Fig. 5-9 illustrates an example of a personnel protective ground).

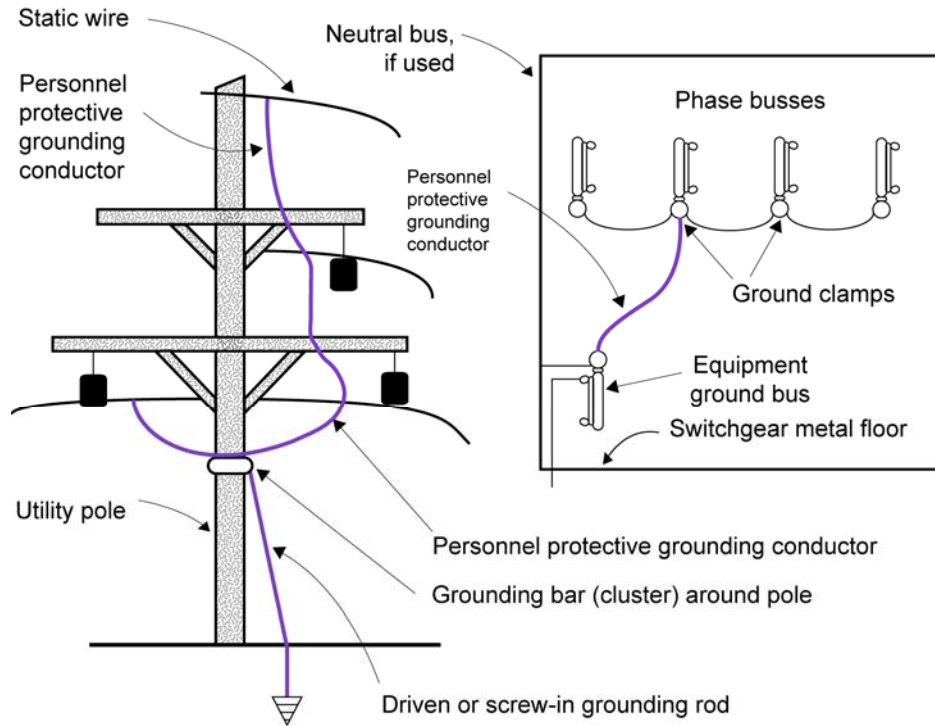

OSHA Sections 29 CFR 1910.269(n) and 1926.954(t)

Fig. 5-9. Equipotential personnel protective grounds.

5.14.2 Criteria for Personnel Protective Grounds

Before personnel protective grounds are selected, the following criteria shall^{5.49} be met for their use, size, and application:

1. A grounding cable shall^{5.50} have a minimum conductance equal to #2 AWG copper.
2. Grounding cables shall^{5.51} be sized large enough to carry fault current long enough for the protective devices to sense and the circuit breaker to clear the fault without damage to cable insulation. An example would be a 4/0 Neoprene-insulated welding cable that is capable of passing 30,000 A for 0.5 seconds without melting its insulation.
3. The following are factors that contribute to adequate capacity:
 - a. Terminal strength depends on the ferrules installed on the cable ends.
 - b. Cross-sectional area to carry maximum current without melting.
 - c. Low resistance to keep voltage drop across the areas in which personnel are working at a safe level during any period to prevent re-energization. The voltage

drop should not exceed 100 V for 15-cycle clearing times or 75 V for 30-cycle clearing times.

- d. Verify that the grounding cable and clamp assembly is tested periodically by using the millivolt drop, micro-ohm meter, AC resistance, or DC resistance test methods. For example, if it is desired to maintain a maximum of 100 V across a worker whose body resistance is 1000 ohms, during a fault of 1000 amperes, a personnel protective ground resistance of 10 milliohms, or less, is calculated.

5.14.3 Grounding Clamps

Grounding clamps used in personnel protective grounds are manufactured specifically for this use. The size of grounding clamps shall^{5.50} match the size of conductor or switchgear bus being grounded.

The ground clamp also shall^{5.50} be rated to handle the full capacity of the available fault currents. Fault currents can typically range in magnitude to over 200,000 A.

5.14.4 Screw-Tightening Devices

Approved screw-tightening devices designed for the purpose of pressure metal-to-metal contact are necessary for connections to an adequate system ground.

5.14.5 Grounding Cable Length

Grounding cables should be no longer than is necessary, both to minimize voltage drop and to prevent violent movement under fault conditions. For example, as a general rule, grounding cables should not exceed 30 feet for a transmission line and 40 feet for substation use.

5.14.6 Grounding Cable Connection

Grounding cables should be connected between phases to the grounded structure and to the system neutral, if present, to minimize the voltage drop across the work area if the circuit should become inadvertently re-energized. Workers shall^{5.52} install the ground end clamp of a grounding cable first and remove it last.

5.14.7 Connecting Grounding Cables in Sequence

Grounding cables shall^{5.52} be connected to the ground bus, structure, or conductor first, then to the individual phase conductors. The first connection of the grounding cables to the circuit phase conductors should be to the closest phase of the system and, then to each succeeding phase in the order of closeness.

5.14.8 Removing Protective Grounds

When removing personnel protective grounds, the order in which they were applied to the phases should be reversed. The grounding cable conductors attached to the ground bus, structure, or conductors shall^{5.53} always be removed last.

5.14.9 Protective Apparel and Equipment

Protective apparel shall^{5.54} be worn when applying or removing grounds. An insulating tool (hot stick) shall^{5.52} be used to install and remove grounding cables.

Protective apparel should include at least the following (see Section 2.11):

1. Safety glasses and, if necessary, a face shield appropriate for existing fault currents;
2. Hardhat (Class E);
3. Appropriate electrical gloves and protectors; and
4. Appropriate AR clothing.

6.0 SPECIAL OCCUPANCIES

This section covers the specific requirements and information for installing electrical equipment and wiring in explosive and hazardous locations and underground facilities. Classifications of areas or locations with respect to hazardous conditions are covered. Information is provided on the correct methods and techniques needed for system grounding, lightning protection, and controlling of static electricity.

This section references DOE, NFPA, and Department of Defense (DoD) standards and manuals. These standards and manuals should be used to ensure safe and reliable installations of electrical equipment and wiring methods in explosive and hazardous locations.

6.1 EXPLOSIVES

This section references DOE M 440.1-1, *Explosives Safety Manual*; NFPA 70; NFPA 77; NFPA 780; and DoD 6055.9-STD, *DoD Ammunition and Explosives Safety Standards*. As noted above, these standards and manuals should be used to ensure safe and reliable installations of electrical equipment and wiring methods in explosive and hazardous locations.

6.1.1 Evacuation

Whenever an electrical storm approaches, personnel shall^{6.1.6.2} exit any location where a hazard exists from explosives being detonated by lightning. Evacuation may be necessary from locations listed below:

1. All outdoor locations, locations in buildings that do not have lightning protection, and locations within an inhabited building distance of the hazard. (When an electrical storm is imminent, work with explosives operations shall^{6.2} not be undertaken.); and
2. Locations (with or without lightning protection) where operations use electrostatic-sensitive bulk explosives or electro-explosive devices (EEDs).

6.1.2 Shutdown of Operations

The following guidelines shall^{6.2} be used for shutdown of an operation during an electrical storm:

1. Process equipment containing explosives shall^{6.2} be shut down as soon as safety permits.
2. When buildings or bays containing explosives are evacuated, functions that cannot be shut down immediately shall^{6.2} be operated by the minimum number of personnel necessary for safe shutdown. When the operation has been brought to a safe condition, those remaining personnel shall^{6.2} evacuate.
3. Automatic emergency power equipment shall^{6.2} be provided if electrical power is critical to an explosives operation during a power shutdown or interruption.

6.1.3 Lightning Protection

It is DOE policy to install lightning protection on all facilities used for storage, processing, and handling of explosive materials where operations cannot be shut down and personnel evacuated during electrical storms. Specific operations should be assessed for the risk of detonation of explosives by lightning. Such assessment should consider the need for the protection factors outlined in NFPA 780, Chapter 8. When risk is high, as in operations with highly sensitive electrostatic materials or components, operations should be conducted only in

lightning-protected facilities. Approved lightning-protection systems shall^{6.2} conform to the requirements of NFPA 780, Chapter 8.

Lightning-protection systems should be visually inspected every seven months and a report on their conditions filed at least annually. Any evidence of corrosion, broken wires or connections, or any other problem that negates the system's usefulness should be noted and the problem repaired.

Lightning-protection systems should be tested electrically every 14 months to ensure testing during all seasons, or immediately following any repair or modification. The testing shall^{6.3} be conducted only with instruments designed specifically for earth-ground system testing. The instruments should be able to measure 10 ohms $\pm 10\%$ for ground resistance testing and 1 ohm $\pm 10\%$ for bonding testing. Electrical resistance readings should be recorded.

Inspection records shall^{6.4} contain the most recent electrical test report, as well as any subsequent visual inspection reports for each building with a lightning-protection system.

6.1.4 Static Electricity

Static electricity shall^{6.5} be controlled or eliminated in areas where materials are processed or handled that are ignitable by static spark discharge. This category includes spark-sensitive explosives, propellants, and pyrotechnics, as well as solvent vapors and flammable gases. Approved systems to dissipate static electricity should conform to the requirements of DOE M 440.1, *Explosives Safety Manual*.

6.1.4.1 Bonding and Grounding Equipment

Bonding straps should be used to bridge locations where electrical continuity may be broken by the presence of oil on bearings, or by paint or rust at any contact point. Permanent equipment in contact with conductive floors or tabletops is not considered adequately grounded. Static grounds shall^{6.6} not be made to: gas, steam, or air lines; dry-pipe sprinkler systems; or, air terminals of lightning-protection systems. Any ground that is adequate for power circuits or lightning-protection is more than adequate for protection against static electricity.

6.1.4.2 Testing Equipment Grounding Systems

Grounding systems shall^{6.7} be tested for electrical resistance and continuity when installation is complete and, in the case of active equipment, at intervals to be locally determined. The grounding system shall^{6.7} be visually inspected for continuity before it is reactivated, if the equipment has been inactive for more than one month. All exposed explosives or hazardous materials shall^{6.7} be removed before testing. During a test for resistance to ground, all equipment, except belt-driven machines, should be considered as a unit. In measuring the total resistance to ground for belt-driven machinery (to ensure compliance with Section 6.1.4.3), resistance of the belt is to be excluded. All conductive parts of equipment shall^{6.8} be grounded so that resistance does not exceed 25 ohms, unless resistance is not to exceed 10 ohms because of the lightning protection system. For existing equipment, the rate of static electricity generation should be considered before changes are made in grounding systems. The resistance of conductive rubber hose should not exceed 250,000 ohms.

6.1.4.3 Conductive Floors, Shoes, Mats, and Wristbands

Conductive floors and shoes should be used for grounding personnel conducting operations involving explosives that have an electrostatic sensitivity of 0.1 joule (J) or less. Many

flammable liquids and air mixtures can be ignited by static discharge from an individual. In areas where personnel come close enough to have possible contact with static-sensitive explosives or vapors, conductive floors shall^{6.9} be installed, except where the hazards of dust-air or flammable vapor-air mixtures are eliminated by adequate housekeeping, dust collection, ventilation, or solvent-recovery methods. Conductive floors may also be required where operations are performed involving EEDs that contain a static-sensitive explosive.

Conductive floors are not necessary throughout a building or room if the hazard remains localized. In such cases, conductive mats or runners may suffice. These mats or runners shall^{6.10} be subject to all the specifications and test requirements that apply to conductive floors. Conductive wristbands may be substituted for conductive mats and footwear at fixed, grounded workstations or outdoor locations.

6.1.4.4 Specifications for Conductive Floors and Wristbands

Conductive floors shall^{6.11} be made of non-sparking materials such as conductive rubber, or conductive flooring material, and shall^{6.11} meet the following requirements:

1. The flooring and its grounding system shall^{6.12} provide for electrical resistance not to exceed 1,000,000 ohms (measured as specified in Section 6.1.4.5).
2. The surface of the installed floor shall^{6.13} be reasonably smooth and free from cracks. The material shall^{6.13} not slough off, wrinkle, or buckle under operating conditions. Conductive tiles are not recommended for use in areas where contamination can be caused by explosive dust. The large number of joints and the tendency of tiles to loosen may provide areas where explosive dust can become lodged and that are not easy to clean with normal cleaning procedures.
3. Where conductive floors and shoes are required, resistance between the ground and the wearer shall^{6.14} not exceed 1,000,000 ohms, which is the total resistance of conductive shoes on a person plus the resistance of floor to ground. Where conductive floors and shoes are required, tabletops on which exposed explosives or dust are encountered should be covered with a properly grounded conductive material meeting the same requirements as those for flooring.
4. Conductive floors shall^{6.15} be compatible with the explosive materials to be processed.
5. Conductive wristbands shall^{6.16} not exceed a resistance of 1,200,000 ohms between the wearer and ground. This resistance shall^{6.16} be measured with a suitably calibrated ohmmeter. Wristbands shall^{6.16} be of a design that maintains electrical contact with the wearer when tension is applied to the ground lead wire or the wristband is placed under strain.

6.1.4.5 Conductive Floor Test

Before use, tests shall^{6.17} be conducted on all conductive floors. Subsequent tests shall^{6.17} be made at least semiannually. Test results shall^{6.17} be permanently recorded and a copy filed in a central location. Instruments used in testing shall^{6.17} be used only when the room is free from exposed explosives and mixtures of flammable gases.

Maximum floor resistance shall^{6.18} be measured with a suitably calibrated insulation resistance tester that operates on a normal open-circuit output voltage of 500 V DC and a short-circuit current of 2.5 mA with an effective internal resistance of approximately 200,000 ohms. Minimum floor resistance shall^{6.18} also be measured with a suitably calibrated ohm meter.

Each electrode shall^{6.19} weigh 2.3 kilograms (kg) and shall^{6.19} have a dry, flat, circular contact area 6.5 centimeters (cm) in diameter, which shall^{6.19} comprise a surface of aluminum or tinfoil 1.3 to 2.5 millimeters (mm) thick, backed by a layer of rubber 0.6 to 0.65 cm thick, and measuring between 40 and 60 durometer hardness as determined with a Shore Type A durometer.

The floor shall^{6.20} be clean and dry. Only electrode jelly should be used to establish a good contact. (Brushless shaving soap and saline solution shall^{6.20} not be used.)

The resistance of the floor shall^{6.21} be more than 5,000 ohms in areas with 110-V service, 10,000 ohms in areas with 220-V service, and less than 1,000,000 ohms in all areas, as measured between a permanent ground connection and an electrode placed at any point on the floor, and also as measured between two electrodes placed 3 feet apart at any points on the floor. Measurements shall^{6.21} be made at five or more locations in each room. If the resistance changes appreciably during a measurement, the value observed after the voltage has been applied for about 5 seconds shall^{6.21} be considered the measured value. (See Fig. 6-1.)

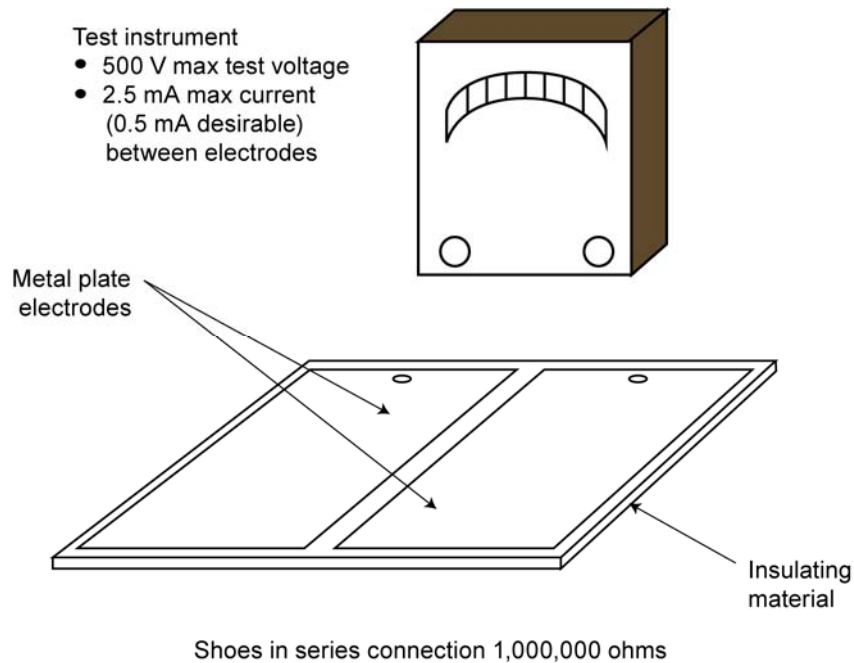

Fig. 6-1. Testing shoes on wearer.

6.1.4.6 Humidification

Humidification to prevent accumulations and subsequent discharges of static electricity is usually effective if the relative humidity is above 60%. However, certain materials, such as metallic powders and some pyrotechnic mixtures cannot be exposed to air with 60% relative humidity because of the possibility of spontaneous ignition. Where this technique is used to prevent accumulations of static electricity, a daily check of the humidity levels should be performed before work starts.

6.1.4.7 Ground-Fault Circuit Interrupter

GFCI protection should be provided in static-grounded areas where personnel are using hand-held, portable, AC-powered electrical equipment operating at 120 V.

6.1.5 Electrical Equipment and Wiring

Electrical equipment and wiring in locations containing explosives shall^{6.22} comply with relevant provisions of the NEC and DOE regulations, plus the requirements in this section.

6.1.5.1 Hazardous Locations

According to DOE M 440.1-1A, *Explosives Safety Manual*, Revision 9F Chapter II Section 8.0, 8.1d(3), NEC definitions of, and requirements for, hazardous locations Class I and Class II are modified as follows for application to DOE explosives facilities:

1. Areas containing explosive dusts or explosives which may, through handling or processing, produce dust capable of being dispersed in the atmosphere shall^{6.23} be regarded as Class II Division 1 hazardous locations.
2. Areas that contain exposed explosives, but where no dust hazard exists, shall^{6.24} be regarded as Class II Division 2 hazardous locations.
3. Suitable National Electrical Manufacturers Association (NEMA)-rated enclosures shall^{6.25} (NEC 110.20) be provided in those locations where water/explosives mixtures may contact electrical equipment and wiring.
4. Areas where explosives are processed and sublimation may occur, or where flammable gases or vapor may be present in quantities sufficient to produce explosive or ignitable mixtures, shall^{6.26} be regarded as Class I Division 1 and Class II Division 1 hazardous locations.
5. To ensure a location is assigned to the proper hazardous location class and division, it is necessary to know the properties of the explosives involved therein, including, at a minimum, sensitivity to heat and spark and thermal stability. If the properties of an explosive area are such that Class II Group G equipment provides inadequate surface temperature limits, special protection shall^{6.27} be provided or the equipment will be excluded from the hazardous location. This equipment shall^{6.27} not have a surface temperature exceeding the lowest onset of the exotherm of the explosive as determined by the differential thermal analysis test or the differential scanning calorimetry test. When NEC Class I or II equipment is not available, the substitute equipment shall^{6.28} be purged or sealed to prevent explosives contamination, shall^{6.29} be determined intrinsically safe by facility management, or shall^{6.30} be administratively controlled. If the equipment is purged, it shall^{6.31} be monitored for flow.
6. Areas that contain explosives that are not defined as hazardous locations (areas containing no dust, vapor, gas hazards, or exposed explosives, such as, storage magazines), should be evaluated and documented by facility management to ensure that electrical ignition sources are minimized or should be regarded as NEC Class II.
7. Procedures shall^{6.32} be established by each DOE facility to control the use and modification of electrical equipment in explosives areas and ensure that uniform standards are adhered to throughout the facility.

6.1.5.2 Electrical Supply Systems

There may be multiple hazards where explosives facilities are located near electrical supply lines. To protect against these hazards, the NESC and the following requirements apply to all new construction or major modification and should be considered for existing facilities:

1. Electric lines serving explosive facilities shall^{6.33} be installed underground from a point not less than 50 feet from such facilities. This also applies to communications and instrumentation lines and security alarm systems.
2. Electric service lines required to be close to an explosives facility shall^{6.34} be no closer to that facility than the length of the lines between the poles or towers supporting the lines, unless an effective means is provided to ensure that broken, energized lines cannot come into contact with, and present a hazard to, the facility or its appurtenances.
3. Unmanned electrical substations shall^{6.35} be no closer to explosives facilities than public traffic route distances.
4. Electric transmission lines (carrying 69 kV or more) and the tower or poles supporting them shall^{6.36} be located not closer to explosives than:
 - a. Inhabited-building distance if the line in question is part of a system serving a large, offsite area.
 - b. Public traffic route distance if loss of the line shall^{6.36} not create serious social or economic hardships.
 - c. Underground utility separation distance criteria found in Table 6-1.

Quantity of explosive (maximum pounds)	Distance, m (ft)
100	26 (80)
200	26 (80)
500	26 (80)
1,000	26 (80)
2,000	26 (80)
5,000	26 (80)
10,000	26 (80)
20,000	28 (85)
50,000	36 (110)
100,000	46 (140)
250,000	62 (190)

Table 6-1. Quantity-distance separation for protection of underground service installations^a

^a If the planned building is designed to contain the effects of an explosion, the formula $D \text{ (distance)} = 3.0 w^{1/3}$ (w=weight) can be used to determine separation distances for less than 20,000 lb.

6.1.5.3 Building Service Entrance

1. The electrical service entrance for explosives facilities should be provided with: an intermediate, metal-oxide surge lightning arrester on the primary side of the transformer;
2. Surge arresters and surge capacitors on the supply side of the main service disconnect; and
3. Interconnected grounding between the lightning arrester, surge arrester, surge capacitors, service entrance ground, and building ground.

6.1.6 Testing

Certain provisions shall^{6.37} be complied with before tests are performed. Qualified personnel shall^{6.37} be used to determine the time and procedure of the test.

6.1.6.1 Test Setup

In setting up a test at a firing site, all preparatory work should be completed before explosives are received. Such work should include the following items:

1. Checking all firing site safety devices at regular intervals. Such safety devices include warning lights, door and gate firing circuit interlocks, emergency firing circuit cutoff switches, and grounding devices (including those that are remote from the firing bunker).
2. Completing all firing pad and shot stand setup work that requires power tools or other potential spark-producing devices. The firing pad shall^{6.38} be cleared of all unnecessary gear. Special precautions and procedures shall^{6.38} be developed and implemented if power tools or other spark-producing devices are needed after the explosive has been received at the firing pad.
3. If a special structure is required, as much work as possible should be accomplished on it, including assembly of all materials.
4. When possible, all diagnostic equipment shall^{6.39} be set up and checked, and dry runs shall^{6.39} be performed.

6.1.6.2 Pin Switches and Other Non-initiating Circuits

Whenever pin switches and other non-initiating circuits are to be checked (such as for charging current or leakage) and are in contact with, or close to, explosives, the check should be performed remotely. Other non-initiating electrical circuits include strain gauges, pressure transducers, and thermocouples, which may be affixed to, or close to, the explosives within an assembly. If a continuity-only (resistance) check is desired, this may be accomplished as a contact operation with an electrical instrument approved for use with the particular explosive device. When low-firing current actuators are involved, it may be advisable to conduct these tests remotely.

6.1.6.3 Lightning Storms

All operations in open test-firing areas shall^{6.40} be discontinued during lightning storms when explosives are present. Completion of a test after receipt of a lightning alert should be allowed only if test preparation has progressed to the extent that discontinuance of testing would represent a greater personnel risk than would completion of testing.

6.1.6.4 Low-Energy Electro-Explosive Devices

When using hot-wire or low-energy EEDs for a test firing, the following requirements shall^{6.41} be applied:

1. Establishment of procedures to ensure that radio frequency (RF), frequency modulation (FM), and TV transmitters having sufficient output energy to initiate an EED at the test site are either restricted to a safe distance from the site or not operated. Tables 6-2, 6-3, and 6-4 specify minimum safe distances for the various types of transmitters at several output power levels.

Transmitter Power (watts)	Minimum Safe Distances (ft)	
	Commercial Amplitude Modulation (AM) broadcast transmitters	High Frequency (HF) transmitters other than AM
100	750	750
500	750	1,700
1,000	750	2,400
4,000	750	4,800
5,000	850	5,500
10,000	1,300	7,600
25,000	2,000	12,000
50,000 ^a	2,800	17,000
100,000	3,900	24,000
500,000 ^b	8,800	55,000

^a Present maximum power of U.S. broadcast transmitters in commercial AM broadcast frequency range (0.535 to 1.605 MHz).

^b Present maximum for international broadcast.

Table 6-2. Minimum safe distances between RF transmitters and electric blasting operations.

Effective Radiation Power (watts)	Minimum Safe Distances (ft)		
	Channels 2-6 & FM	Channels 7-13	Ultra High Frequency (UHF)
Up to 1,000	1,000	750	600
10,000	1,800	1,300	600
100,000 ^a	3,200	2,300	1,100
316,000 ^b	4,300	3,000	1,450
1,000,000	5,800	4,000	2,000
5,000,000 ^c	9,000	6,200	3,500
10,000,000	10,200	7,400	6,000
100,000,000	-	-	-

^a Present maximum power, channels 2 to 6 and FM.

^b Present maximum power, channels 7 to 13.

^c Present maximum power, channels 14 to 83.

Table 6-3. Minimum safe distances between TV and FM broadcasting transmitters and electric blasting operations.

Transmitter Power (watts)	Minimum Safe Distances (ft)				
	MF ^b	HF ^b	VHF(1) ^b	VHF(2) ^{b,c}	UHF ^b
5 ^a	-	-	-	-	-
10	40	100	40	15	10
50	90	220	90	35	20
100	125	310	130	50	30
180 ^b	-	-	-	65	40
250	200	490	205	75	45
500 ^c	-	-	209	-	-
600 ^d	300	760	315	115	70
1,000 ^e	400	980	410	150	90
10,000 ^f	1,200	-	1,300	-	-

MF ^b	1.6 to 3.4 MHz	Industrial
HF	28 to 29.7 MHz	Amateur
VHF(1)	35 to 44 MHz	Public use
	50 to 54 MHz	Amateur
VHF(2)	144 to 148 MHz	Amateur
	150.8 to 161.6 MHz	Public use
UHF	450 to 460 MHz	Public use

^a Citizens band radio (walkie-talkie), 26.96 to 27.23 MHz and cellular telephones, 3 watts power, 845 MHz; minimum safe distance; 5 feet.

^b Maximum power for 2-way mobile units in VHF, 15.08- to 161.6-MHz range, and for 2-way mobile and fixed station units in UHF, 450- to 460-MHz range.

^c Maximum power for major VHF 2-way mobile and fixed-station units in 35- to 44-MHz range.

^d Maximum power for 2-way fixed-station units in VHF, 150.8- to 161.6-MHz range.

^e Maximum power for amateur radio mobile units.

^f Maximum power for some base stations in 42- to 44-MHz band, 1.6- to 1.8- MHz band.

Table 6-4. Minimum safe distances between mobile RF transmitters and electric blasting operations.

1. Blasting caps and other low-firing current igniters or detonators shall^{6.42} be kept separate from explosives at all times, except during actual test charge assembly and setup.
2. The entire wiring system of the explosive charge and of any low-firing-current initiators shall^{6.43} be kept insulated at all times from every possible source of extraneous current. Shunts shall^{6.43} be left on all low-energy initiators or lead wires until actual connections are to be made. Connections shall^{6.43} be taped or otherwise insulated.
3. Test unit low-firing-current actuators or detonators shall^{6.44} be clearly marked. No contact operations involving electrical testing shall^{6.44} be permitted on this type of unit unless an electric meter for the specific application is used.

6.1.6.5 Warning Signals

Each DOE explosives testing facility shall^{6.45} use standard audible signals to warn personnel of any impending firing in a test area. Signals shall^{6.45} be established by each facility and approved by facility management.

6.1.6.6 Firing Leads

All detonator lead wires shall^{6.46} be electrically insulated. Firing leads or cables of low-energy detonators for explosive assemblies shall^{6.46} be kept properly shorted during setup on the firing point.

6.1.6.7 Electrical Testing Instruments for Use with Explosives Systems

Testing instruments shall^{6.47} meet certain criteria and be certified and labeled for the types of testing they are permitted to perform.

6.1.6.7.1 Classification

Testing instruments shall^{6.48} be assigned to categories on the basis of electrical characteristics that affect their safe use with explosives systems. Specifically, instrument categories shall^{6.48} be established so that testing instruments in each category can be safely applied to one or more of the following classes of explosives systems:

1. Low-energy or hot-wire initiators (blasting caps, actuators, squibs, etc.);
2. High-energy initiators (exploding bridge wires, slappers, etc.); or
3. Non-initiating electrical circuits.

Testing instruments that do not meet the safety criteria may be used on an explosives system only if the activity is considered a remote operation and adequate personnel shielding or separation distance is provided.

6.1.6.7.2 Certification

Each DOE facility using electrical testing instruments on explosives systems shall^{6.49} establish a formal system for reviewing and certifying those instruments. Procedures for marking instruments to show their approved use, along with restrictions on their use, should also be established, so that every testing instrument is prominently labeled with its approved use and with a warning if there is a restriction on its use.

Inspection and calibration of certified instruments shall^{6.50} be required at prescribed intervals, or whenever the instrument is opened for servicing or repair.

Records of all certified testing instruments shall^{6.51} be maintained by each DOE facility using electrical instruments to test explosives systems. These records should include type, manufacturer, model, electrical specifications, wiring diagrams, and failure mode analyses.

6.1.6.7.3 Electrical Testing Instruments for Use with Initiating Electrical Circuits

Instruments used with electrical initiating circuits connected to electro-explosive devices may be further categorized for use with either low-energy initiators or high-energy initiators. All testing instruments used for this purpose shall^{6.52} be current-limited. Before being used on initiating circuits, every instrument wiring diagram and internal circuitry design shall^{6.52} be analyzed, examined, and certified for the following:

1. The output current through a resistance equivalent to that of the minimum resistance initiator of the class should not exceed 1% and shall^{6.53} not exceed 10% of the no-fire rating for the most sensitive initiator of the class. The current-limiting features of the testing instrument shall^{6.53} be internal to the instrument and shall^{6.53} not depend on the circuit load characteristics.

2. The internal circuitry shall^{6.54} ensure isolation features that require, at a minimum, two independent failure modes before the specified output current can be exceeded.
3. A comprehensive (point-to-point, if possible) wiring check should be made to ensure that the wiring corresponds to the diagram and that all components are functioning properly and within specifications.

6.1.6.7.4 Electrical Testing Instruments For Use With Non-initiating Electrical Circuits

Testing instruments in this category are used with electric circuits connected to instruments, such as strain gauges, pin switches, pressure transducers, thermocouples, and electrical components that are affixed to or within an assembly with explosives. These instruments shall^{6.55} meet the following requirements:

1. Each use of the testing instrument shall^{6.56} be analyzed to ensure there is no credible scenario in which the normal test energy from the testing instrument can ignite explosive charges or initiators in the test. This testing should be consistent with Section 6.1.6.7.3.
2. Where a testing instrument is used to make measurements on sensors directly applied to explosives (e.g., bonded strain gauges or pin switches), the testing instrument shall^{6.57} be certified and controlled.
3. Testing instruments shall^{6.58} be prominently marked with restrictions on their use. Many of these testing instruments do not meet the requirements for use with initiating systems and shall^{6.58} be marked to prevent their use on this type of circuit.

6.2 PREVENTION OF EXTERNAL IGNITION AND EXPLOSION

Explosives can ignite under many conditions, but around electricity they become even more dangerous since an arc, spark, or hot surface can easily touch off an explosion. Therefore, the electrical installation shall^{6.59} contain these ignition sources or house them in an area well separated from the explosives storage area.

The electrical installation shall^{6.59} prevent accidental ignition of flammable liquids, vapors, and dusts in the atmosphere. In addition, because portable electrical equipment is often used outdoors or in corrosive atmospheres, its material and finish should be such that maintenance costs and shutdowns are minimized. (See Fig. 6-2.)

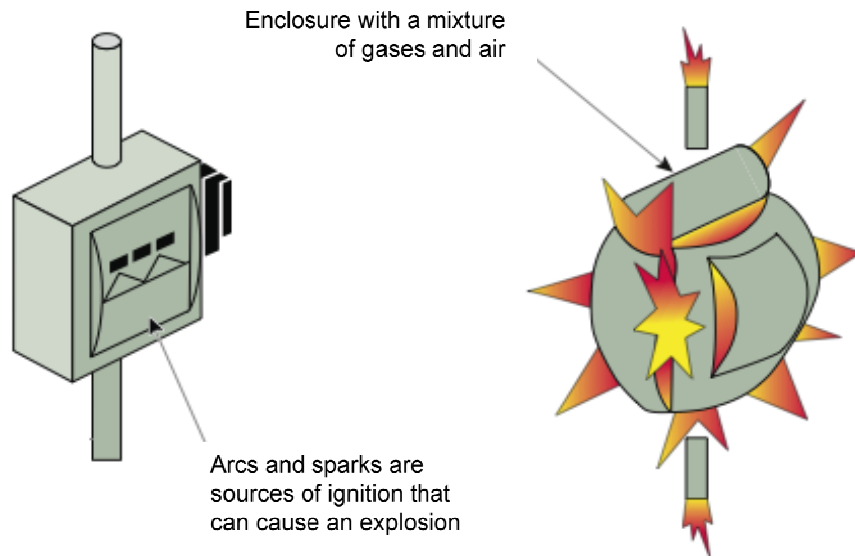

Fig. 6-2. Electrical sources of ignition.

6.2.1 Sources of Ignition

When flammable gases or combustible dusts are mixed in the proper proportion with air, a source of energy is all that is needed to touch off an explosion. One prime source of energy is electricity. During normal operation, equipment such as switches, circuit breakers, motor starters, pushbutton stations or plugs, and receptacles can produce arcs or sparks when contacts are opened and closed, which can easily cause ignition. Other energy hazards are devices that produce heat, such as lighting fixtures and motors. Surface temperatures of these devices may exceed the safe limits of many flammable atmospheres. Finally, many parts of the electrical system can become potential sources of ignition in the event of insulation failure. Included in this category are wiring (particularly splices), transformers, impedance coils, solenoids, and other low-temperature devices without make-or-break contacts.

Non-electrical sources, such as sparks from metal can also easily cause ignition. A hammer, file, or other tool dropped on masonry, or on a nonferrous surface, could be a hazard, unless it is made of non-sparking material. For this reason, portable electrical equipment is usually made from aluminum or other material that does not produce sparks if it is dropped.

6.2.2 Combustion Principles

The following three basic conditions are necessary for a fire or explosion to occur:

1. A flammable liquid, vapor, or combustible dust is present in sufficient quantity;
2. A flammable liquid, vapor, or combustible dust mixes with air or oxygen in the proportion necessary to produce an explosive mixture; and
3. A source of energy is applied to the explosive mixture.

In applying these principles, the quantity of the flammable liquid or vapor that may be liberated and its physical characteristics are taken into account. Also, vapors from flammable liquids have a natural tendency to disperse into the atmosphere and rapidly become diluted to concentrations below the lower explosion limit, particularly when there is natural or mechanical ventilation. Finally, the possibility that the gas concentration may be above the upper explosion

limit does not ensure any degree of safety since the concentration first passes through the explosive range to reach the upper explosion limit.

6.2.3 Evaluation of Hazardous Areas

Each area that contains gases or dusts that are considered hazardous shall^{6.59} be carefully evaluated to make certain that the correct electrical equipment is selected. Many hazardous atmospheres are Class I Group D or Class II Group G. However, certain areas may involve other groups, particularly Class I Groups B and C. Conformity with the NEC requires the use of fittings and enclosures approved for the specific hazardous gas or dust involved. A person cognizant of the requirements should make the determination of the area classification wiring and equipment selection for Class I, II, and III areas. The determination of the area classification, wiring, and equipment selection for Class I, Zone 0, 1, and 2 areas shall^{6.60} be under the supervision of a qualified person.

6.2.4 Intrinsically Safe Equipment

The use of intrinsically safe equipment is primarily limited to process control instrumentation because these electrical systems lend themselves to the low energy requirements. The installation rules are covered in Article 504 of the NEC. The definition of intrinsically safe equipment and wiring is, "Equipment and wiring that are incapable of releasing sufficient electrical energy under normal or abnormal conditions to cause ignition of a specific hazardous atmospheric mixture in its most easily ignited concentration." The UL and the Factory Mutual list several devices in this category. The equipment and its associated wiring shall^{6.61} be installed such that they are positively separated from the non-intrinsically safe circuits. Induced voltages could defeat the concept of intrinsically safe circuits.

6.2.5 Enclosures

In Class I Division 1 and 2 locations, conventional relays, contactors, and switches that have arcing contacts shall^{6.62} be enclosed in explosion-proof housings, except for those few cases where general-purpose enclosures are permitted by the NEC. By definition, enclosures for these locations shall^{6.63} prevent the ignition of an explosive gas or vapor that may surround it. In other words, an explosion inside the enclosure should not start a larger explosion outside. Adequate strength is necessary for such an enclosure. For an explosion-proof enclosure, a safety factor of 4 is used. That is, the enclosure should withstand a hydrostatic pressure test of four times the maximum pressure from an explosion within it.

In addition to being strong, the enclosure should be flame-tight. This term does not imply that the enclosure is hermetically sealed, but rather that the joints cool the hot gases resulting from an internal explosion so that, by the time they reach the outside hazardous atmosphere, they are too cool to affect ignition. The strains and stresses caused by internal explosive pressures are illustrated in Fig. 6-3 (dotted lines indicate the shape that a rectangular enclosure strives to attain under these conditions). Openings in an enclosure strive to maintain the shape of the enclosure. Openings in an explosion-proof enclosure can be threaded-joint type or flat-joint type. Threaded joints can be used as an escape path to cool the hot gases as they pass through the threads to the outside of the enclosure (Fig. 6-4). Flat joints in an explosion-proof enclosure are illustrated in Fig. 6-5.

In Class II locations, the enclosure should keep dust out of the interior and operate at a safe surface temperature. Because there are no internal explosions, the enclosure may have thinner wall sections. The construction of these enclosures is known as dust-ignition-proof.

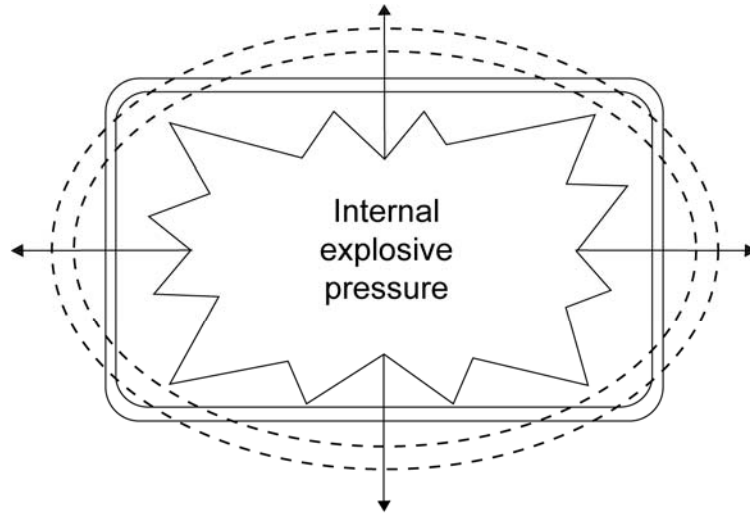

NEC Article 500

Fig. 6-3. Strains and stresses caused by an internal explosion.

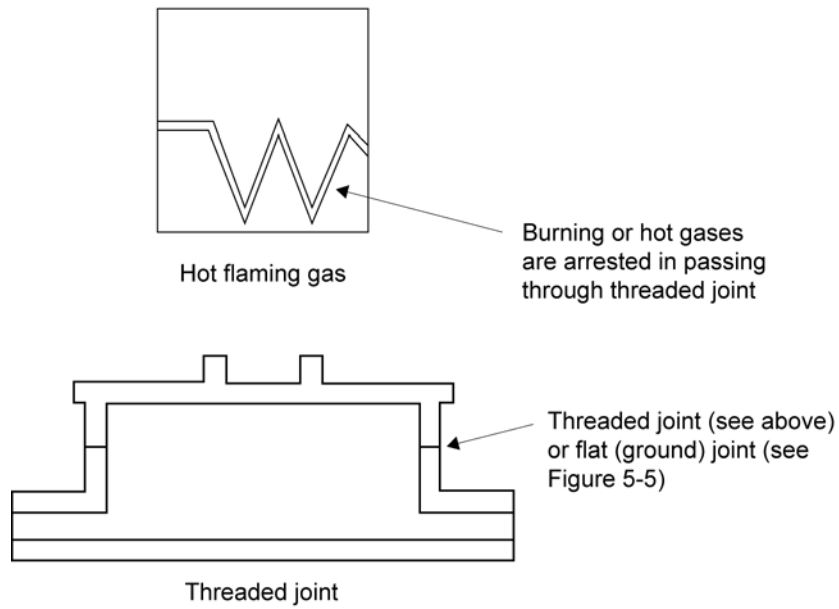

NEC Article 500

Fig. 6-4. Threaded joints in an explosion-proof enclosure.

**NEC Article 500**

Fig. 6-5. Flat joints in an explosion proof enclosure.

6.2.6 Purging/Pressurization Systems

Purging/pressurization systems permit the safe operation of electrical equipment under conditions of hazard for which approved equipment may not be commercially available. For instance, most switchgear units and many large motors do not come in designs listed for Class I Groups A and B. Whether cast-metal enclosures or sheet-metal enclosures with pressurization should be used for hazardous locations is mainly a question of economics, if both types are available. As a typical example, if an installation had many electronic instruments that could be enclosed in a single sheet-metal enclosure, the installation lends itself to the purging/pressurization system. However, if the electronic instruments require installation in separate enclosures, use of the cast metal in hazardous-location housing would almost invariably prove more economical. Pressurized enclosures need:

1. A source of clean air or inert gas;
2. A compressor to maintain the specified pressure on the system; and
3. Pressure control valves to prevent the power from being applied before the enclosures have been purged and to de-energize the system should pressure fall below a safe value.

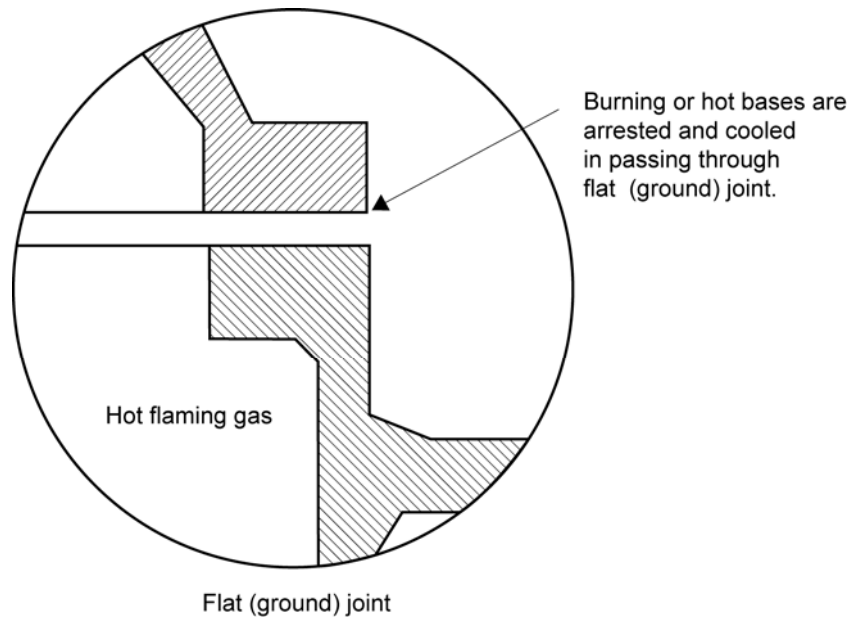
In addition, door-interlock switches prevent access to the equipment while the circuits are energized. All of these accessories can add up to a considerable expenditure. For a detailed description of purging/pressurizing systems see NFPA 496, *Purged and Pressurized Enclosures for Electrical Equipment in Hazardous Classified Locations*.

6.3 HAZARDOUS LOCATIONS

Group, class, and division classify hazardous areas and locations. The atmospheric mixtures of various gases, vapors, dust, and other materials present determine these classifications. The intensity of the explosion that can occur depends on concentrations, temperatures, and many other factors that are listed in OSHA and NFPA codes and standards.

It is important that hazardous locations are well understood by anyone designing, installing, working on, or inspecting electrical equipment and wiring in such areas. Such locations carry a threat of flammable or combustible gases, vapors, or dusts being present some, or all, of the time.

Information in this section assists in classifying areas or locations with respect to hazardous conditions, whether from atmospheric concentrations of hazardous gases, vapors, and deposits, or from accumulations of readily ignitable materials.

This section covers the requirements for electrical equipment and wiring in locations that are classified according to the properties of the flammable vapors, liquids, or gases or combustible dusts that may be present and the likelihood that a flammable or combustible concentration is present. The hazardous (classified) locations are assigned the following designations:

1. Class I Division 1
2. Class I Division 2
3. Class II Division 1
4. Class II Division 2

6.3.1 Class I

Class I locations are identified in the NEC as those in which flammable gases or vapors are, or may be, present in the air in amounts sufficient to create explosive or ignitable mixtures. Gases or vapors may be continuously or intermittently present. However, if a gas or vapor is present, there is a potential that a flammable mixture also is present.

From an engineering standpoint, greater precautions are needed if a particular set of conditions is likely to occur (e.g., the presence of a flammable mixture within the explosive range) than if it is unlikely. This is the reason for dividing hazardous locations into two divisions.

6.3.1.1 Class I Division 1

NEC 500.5 defines Class I Division 1 hazardous locations as those in which:

1. Ignitable concentrations of flammable gases, liquids, or vapors can exist under normal operating conditions;
2. Ignitable concentrations of such gases or vapors may exist frequently because of repair or maintenance operations or because of leakage; or
3. Breakdown or faulty operation of equipment or processes might release ignitable concentrations of flammable gases, liquids, or vapors and might also cause simultaneous failure of electrical equipment.

Note: In each case, ignitable concentrations are mentioned. This means concentrations between the lower- and upper-flammable or explosion limits. (See Section 6.3.5 and Table 6-5.)

The fine-print note to NEC 500.5(B)(1) describes a number of areas and occupancies normally classified as Class I Division 1 locations.

NEC Article 100 defines a volatile flammable liquid as one that has a flashpoint below 38°C (100°F) or one whose temperature is raised above its flashpoint. Flashpoint is the lowest temperature to which a combustible or flammable liquid may be heated before sufficient vapors are driven off and the liquid is capable of ignition when brought into contact with a flame, arc, spark, or another ignition source. (See Section 6.3.6 and Section 1-3 of NFPA 497M, *Classification of Gases, Vapors and Dust for Electrical Equipment in Hazardous Classified Locations*, for more details.)

DOE-HDBK-1092-2013

Group ³	Atmosphere	Ignition ¹ Temp		Ignition ² energy (millijoules)	Flammable limits ³ (% by volume)		Flashpoint ³		NEMA enclosure ⁴ classification	
		°F	°C		Lower	Upper	°F	°C	Indoor	Outdoor
A	Acetylene	581	305	0.017	2.5	100.0	Gas	Gas	7	8
B	1,3-butadiene	788	420	-	2.0	12.0	Gas	Gas	7	8
B	Ethylene oxide	804	429	-	3.0	100.0	-20	-28	7	8
B	Hydrogen	968	520	0.017	4.0	75.0	Gas	Gas	7	8
B	Manufactured gas containing more than 30% hydrogen by volume	-	-	-	-	-	-	-	-	-
B	Propylene oxide	840	449	-	2.6	36.0	-35	-37	7	8
C	Acetaldehyde	347	175	-	4.0	60.0	-38	-39	7	9
C	Diethyl ether	320	160	-	1.9	36.0	-49	-45	7	8
C	Ethylene	842	450	0.08	2.7	36.0	Gas	Gas	7	8
C	Unsymmetrical dimethyl hydrazine (UDMH)	480	249	-	2.0	95.0	5	-15	7	8
D	Acetone	869	465	-	2.5	13.0	-4	-20	7	8
D	Acrylonitrile	898	481	-	3.0	17.0	32	0	7	8
D	Ammonia	928	498	-	15.0	28.0	Gas	Gas	7	8
D	Benzene	928	498	-	1.3	7.9	12	-11	7	8
D	Butane	550	288	-	1.6	8.4	Gas	Gas	7	
D	1-butanol	650	343	-	1.4	11.2	98	37	7	8
D	2-butanol	761	405	-	1.7@212°F	9.0@212°F	75	24	7	8
D	n-butyl acetate	790	421	-	1.7	7.6	72	22	7	8
D	Cyclopropane	938	503	0.25	2.4	10.4	Gas	Gas	7	8
D	Ethane	882	472	-	3.0	12.5	Gas	Gas	7	8
D	Ethanol	685	363	-	3.3	19.0	55	13	7	8
D	Ethylacetate	800	427	-	2.0	11.5	24	-4	7	8
D	Ethylene dichloride	775	413	-	6.2	16.0	56	13	7	8
D	Gasoline	536 to 880	280 to 471	-	1.2 to 1.5	7.1 to 7.6	7	8	7	8
D	Heptane	399	204	-	1.05	6.7	-36 to -50	-38 to -46	7	8

DOE-HDBK-1092-2013

Group ³	Atmosphere	Ignition ¹ Temp.		Ignition ² Energy (millijoules)	Flammable limits ³ (% by volume)		Flashpoint ³		NEMA enclosure ⁴ classification	
		°F	°C		Lower	Upper	°F	°C	Indoor	Outdoor
D	Hexane	437	225	-	1.1	7.5	-7	-22	7	8
D	Isoamyl alcohol	662	350	-	1.2	9.0@212°F	109	43	7	8
D	Isoprene	428	220	-	1.5	8.9	-65	-54	7	8
D	Methane	999	630	0.30	5.0	15.0	Gas	Gas	7	8
D	Methanol	725	385	-	6.0	36.0	52	11	7	8
D	Methyl ethyl ketone	759	404	-	1.7@200°F	11.4@200°F	16	-9	7	8
D	Methyl isobutyl ketone	840	449	-	1.2@200°F	8.0@200°F	64	18	7	8
D	2-methyl-1-propanol	780	416	-	1.7@123°F	10.6@202°F	82	28	7	8
D	2-methyl-2-propanol	892	478	-	2.4	8.0	52	11	7	8
D	Naphtha (petroleum)	550	288	-	1.1	5.9	<0	<-18	7	8
D	Octane	403	206	-	1.0	6.5	56	13	7	8
D	Pentane	470	243	-	1.5	7.8	< -40	< -40	7	8
D	1-pentanol	572	300	-	1.2	10.0@212°F	91	33	7	8
D	Propane	842	450	0.25	2.1	9.5	Gas	Gas	7	8
D	1-propanol	775	413	-	2.2	13.7	74	23	7	8
D	2-propanol	750	399	-	2.0	12.7@200°F	54	12	7	8
D	Propylene	851	455	-	2.0	11.1	Gas	Gas	7	8
D	Styrene	914	490	-	1.1	7.0	88	31	7	8
D	Toluene	896	480	-	1.2	7.1	40	4	7	8
D	Vinyl acetate	756	402	-	2.6	13.4	18	-8	7	8
D	Vinyl chloride	882	472	-	3.6	33.0	Gas	Gas	7	8
D	Xylenes 867 to 984	464 to 529		-	1.0 to 1.1	7.6	81 to 90	27 to 32	7	8

Notes:

¹ See NFPA 325 and 497M.

² See *Handbook of Fire Protection Engineering*, Society of Fire Protection Engineers.

³ See NFPA 325.

⁴ See NEMA 250, *Enclosures for Electrical Equipment*.

Table 6-5. Class I Division 1 and Class I Division 2 summary of selected hazardous atmospheres.

6.3.1.2 Class I Division 2

NEC 500.5(B)(2) defines Class I Division 2 locations as those:

1. In which flammable liquids or gases are handled, processed, or used, but where such materials are normally confined in closed containers or closed systems from which they can escape only in case of accidental rupture or breakdown of such containers or systems, or in case of abnormal equipment operation;
2. In which gases or vapors are normally prevented, by positive mechanical ventilation, from forming ignitable concentrations and that might become hazardous through failure or abnormal operation of the ventilating equipment; or
3. That are adjacent to a Class I Division 1 location and to which ignitable concentrations of gases or vapors might occasionally be transmitted, unless such transmittal is prevented by adequate positive-pressure ventilation from a source of clean air, and effective safeguards against ventilation failure are provided.

The fine-print note #2 to NEC 500.5 describes a number of areas and occupancies normally classified as Class I Division 2 locations. For example, piping systems without valves, meters, and devices do not usually cause a hazardous condition, even though they carry flammable liquids, because they are considered a contained system. Therefore, the surrounding area can be classified as a Class I Division 2 location.

6.3.2 Class II

A Class II location is defined in NEC 500 as an area where combustible dust presents a fire or explosion hazard. Class II locations are divided into two divisions based on the normal presence or absence of dust.

6.3.2.1 Class II Division 1

A Class II Division 1 location is one:

1. In which combustible dust is in the air under normal operating conditions in quantities sufficient to produce explosive or ignitable mixtures;
2. Where mechanical failure or abnormal operation of machinery or equipment might cause such explosive or ignitable mixtures to be produced and might also provide a source of ignition through simultaneous failure of electrical equipment, operation of protective devices, or other causes; or
3. In which combustible dusts of an electrically conductive nature may be present in hazardous quantities. (See Table 6-6.)

DOE-HDBK-1092-2013

Class	Division	Group	Temperature, atmosphere	Covered	Measured	Limiting value
II Combustible dust	1 (Normally hazardous)	E ^b	Atmospheres containing combustible dusts regardless of resistivity, or other combustible dusts of similarly hazardous characteristics having resistivity of less than 10 ² ohm-centimeter	Devices not subject to overloads (switches, meters)	Maximum ambient temperature in 40°C ambient with a dust blanket	Should be less than ignition-temperature dust but not more than: No overload:
		F ^b	Atmospheres containing carbonaceous dusts having resistivity between 10 ² and 10 ⁸ ohm-centimeter	Devices subject to overload (motors, transformers)		E—200°C (392°F) F—200°C (392°F) G—165°C (329°F)
		G ^b	Atmospheres containing dusts having resistivity of 10 ⁸ ohm-centimeter			Possible overload in operation:
				Normal: E—200°C (392°F) F—150°C (302°F) G—120°C (248°F)		
	2 (Not normally hazardous)	F	Atmospheres containing dusts having resistivity of 105 ohm-centimeter	Lighting fixtures	Maximum external temperature under conditions of use	Abnormal E—200°C (392°F) F—200°C (392°F) G—165°C (329°F)
		G	Same as Division 1			

^a Chart from Crouse-Hinds ECM Code Digest, 1990.

^b NEMA Enclosures Type 9 should be used for Class II Groups E, F, or G.

Table 6-6. Summary of typical combustible dust hazardous atmospheres.^a

6.3.2.2 Class II Division 2

A Class II Division 2 location is one where:

1. Combustible dust is not normally in the air in quantities sufficient to produce explosive or ignitable mixtures;
2. Dust accumulations are normally insufficient to interfere with the normal operation of electrical equipment or other apparatus, but where combustible dust may be suspended in the air as a result of infrequent malfunctioning of handling or processing equipment; or
3. Combustible dust accumulations on, in, or in the vicinity of the electrical equipment may be sufficient to interfere with the safe dissipation of heat from electrical equipment or may be ignitable by abnormal operation or failure of electrical equipment. (See Table 6-6.)

6.3.3 Groups

Until the publication of the 1937 edition of the NEC, Class I hazardous locations were not subdivided; a flammable gas or vapor was classified as presenting a single degree of hazard. It was recognized, however, that the degrees of hazard varied with the substance and that equipment suitable for use where gasoline was handled was not necessarily suitable for use where hydrogen or acetylene was handled.

The difficulty of manufacturing equipment and enclosures for use in hydrogen atmospheres was also recognized, as was the expense of the equipment. It was not logical from an engineering standpoint, for example, to require in gasoline stations use of explosion-proof equipment that was also suitable for use in hydrogen atmospheres. Not only would this unnecessarily increase the cost of the electrical installation in one of the most common types of hazardous locations, it would also make some types of equipment unavailable. Even today, there are no listed motors or generators suitable for use in Group A or B atmospheres.

6.3.4 Ignition Temperature

Ignition temperature of a substance, whether solid, liquid, or gaseous, is the minimum temperature necessary to initiate or cause self-sustained combustion, independently of the heating or heated element.

Ignition temperatures observed under one set of conditions may be changed substantially by a change of conditions. For this reason, ignition temperatures should be viewed only as approximations. Ignition temperatures under one set of conditions may be changed substantially by a change of conditions. Some of the variables known to affect ignition temperatures are: percentage composition of the vapor or gas-air mixture; shape and size of the space where the ignition occurs; rate and duration of heating; kind and temperature of the ignition source, catalytic or other effect of materials that may be present; and, oxygen concentration. Another variable is the many differences in methods and conditions of testing ignition temperature (e.g., the size and shape of containers, method of heating, and ignition source).

6.3.5 Flammable (Explosion) Limits

As mentioned in Section 6.3.1.1, in the case of gases or vapors that form flammable mixtures with oxygen, there is a minimum concentration of gas or vapor in air or oxygen below which propagation of flame cannot occur on contact with a source of ignition. There is also a

maximum concentration of vapor or gas in air above which propagation of flame cannot occur. These boundary-line mixtures of vapor or gas with air, which if ignited just propagates flame, are known as the lower and upper flammable or explosion limits and are usually expressed in terms of percentage by volume of gas or vapor in air.

In popular terms, a mixture below the lower flammable limit is too lean to burn or explode and a mixture above the upper flammable limit is too rich to burn or explode.

6.3.6 Flashpoint

The flashpoint of a flammable liquid is the lowest temperature at which the liquid gives off sufficient vapor to form, with the air near its surface or within the vessel used, an ignitable mixture. An ignitable mixture is a mixture that is within the flammable range (between upper and lower explosive limits) that is capable of propagating flame away from the source of ignition when ignited. Some evaporation takes place below the flashpoint, but not in sufficient quantities to form an ignitable mixture. This term applies mostly to flammable and combustible liquids, although there are certain solids, such as camphor and naphthalene that slowly evaporate or volatilize at ordinary room temperature or liquids, such as benzene, that freeze at relatively high temperatures and, therefore, have flashpoints while in the solid state.

6.4 ELECTRICAL EQUIPMENT FOR CLASS I, II, AND III AREAS

A wide variety of explosion-proof, ignition-proof electrical equipment is available for Class I, II, and III areas. Selection of such equipment shall^{6,58} fully comply with current NFPA requirements.

Excellent sources for references of manufacturers' electrical equipment available for hazardous areas are the Crouse-Hinds ECM Code Digest and the Appleton NEC Code Review that are based on the current NEC.

6.4.1 Seals and Drains

Seals are to be provided in conduit and cable systems to minimize the passage of gases or vapors from one portion of the system to another. The seals also keep an explosion from being transmitted and ignition from traveling between sections of the system.

6.4.1.1 Seals

The following are uses and requirements for seals:

1. They restrict the passage of gases, vapors, or flames from one portion of the electrical installation to another at atmospheric pressure and normal ambient temperatures.
2. They limit explosions to the sealed-off enclosure and prevent pre-compression or pressure-piling in conduit systems.
3. While it is not a code requirement, many engineers consider it good practice to divide long conduit runs into sections by inserting seals not more than 50 to 100 feet apart, depending on the conduit size, to minimize the effects of pressure-piling.
4. At each entrance to an enclosure housing with an arcing or sparking device when used in Class I Division 1 and 2 hazardous locations, seals must be as close as practicable to and in no case more than 18 inches from such enclosures.

5. At each 2-inch or larger entrance to an enclosure or fitting housing terminals, splices, or taps when used in Class I Division 1 hazardous locations, seals must be as close as practicable to and in no case more than 18 inches from such enclosures.
6. Seals must be located in conduit systems when the conduit leaves the Class I Division 1 or 2 hazardous locations.
7. Seals must be located in cable systems when the cables either do not have a gas-tight or vapor-tight continuous sheath or are capable of transmitting gases or vapors through the cable core when these cables leave the Class I Division 1 or Division 2 hazardous locations.

NEC 502.5 requires the use of seals in Class II locations under certain conditions. Any approved sealing fittings can be used to meet this requirement.

6.4.1.2 Drains

In humid atmospheres or in wet locations where it is likely that water can enter the interiors of enclosures or raceways, the raceways should be inclined so that water does not collect in enclosures or on seals, but is led to low points where it may pass out through drains. Frequently the arrangement of raceway runs makes this method impractical, if not impossible. In such instances, drain sealing fittings shall^{6.64} be used. These fittings prevent accumulations of water above the seal.

In locations usually considered dry, surprising amounts of water frequently collect in conduit systems. No conduit system is airtight; therefore, it may breathe. Alternate increases and decreases in temperature and barometric pressure because of weather changes, or the nature of the process carried on in the location where the conduit is installed, can cause breathing. Outside air is drawn into the conduit system when it breathes in. If this air carries sufficient moisture, it might be condensed within the system when the temperature decreases and chills the air. With internal conditions being unfavorable to evaporation, the resultant water accumulation remains and is added to by repetitions of the breathing cycle. In view of this likelihood, it is good practice to ensure against such water accumulations and probable subsequent insulation failures by installing drain sealing fittings with drain covers or inspection covers, even though conditions prevailing at the time of planning or installing may not indicate the need.

6.4.1.3 Selection of Seals and Drains

Different types of seals and drains are made to be used for vertical or horizontal installations and are to be used only for the purpose for which they were designed. Care should be taken when selecting and installing such fittings.

6.4.1.3.1 Primary Considerations

The following primary considerations should be used when selecting seals and drains:

1. Select the proper sealing fitting for the hazardous vapor involved (i.e., Class I Groups A, B, C, or D).
2. Select a sealing fitting for the proper use in respect to mounting position. This is particularly critical when the conduit runs between hazardous and non-hazardous areas. Improper positioning of a seal may permit hazardous gases or vapors to enter the system beyond the seal and to escape into another portion of the hazardous area, or

into a non-hazardous area. Some seals are designed to be mounted in any position; others are restricted to horizontal or vertical mounting.

3. Install the seals on the proper side of the partition or wall as recommended by the manufacturer.
4. Only trained personnel should install seals in strict compliance with the instruction sheets furnished with the seals and sealing compound. Precautionary notes should be included on installation diagrams to stress the importance of following manufacturer's instruction.
5. The NEC prohibits splices or taps in sealing fittings.
6. Sealing fittings are listed by an NRTL for use in Class I hazardous locations with sealing compound only. This compound, when properly mixed and poured, hardens into a dense, strong mass, which is insoluble in water, is not attacked by chemicals, and is not softened by heat. It withstands, with ample safety factor, the pressure of exploding trapped gases or vapor.
7. Conductors sealed in the compound may be approved thermoplastic or rubber-insulated type. Either may or may not be lead covered (the lead need not be removed).

Caution: Sealing compounds are not insulating compounds; therefore, they should not be used as such.

6.4.1.3.2 Types of Sealing Fittings

Sealing fittings meet the requirements of NEC when properly installed.

Certain styles of sealing fittings are for use with vertical or nearly vertical conduit in sizes from ½ inch through 1 inch. Other styles are available in sizes ½ inch through 6 inches for use in vertical or horizontal conduits. In horizontal runs, these are limited to face up openings. Sizes from 1¼ inches through 6 inches have extra-large work openings and separate filling holes, so that fiber dams are easy to make. Overall diameter of sizes 1¼ inches through 6 inches is scarcely greater than that of unions of corresponding sizes, permitting close conduit spacing. Other style seals are for use with conduit running at any angle, from vertical through horizontal.

6.5 DESCRIPTIONS, FEATURES, AND TEST CRITERIA OF ENCLOSURES FOR HAZARDOUS (CLASSIFIED) LOCATIONS (PER NEMA 250)

Type 7 and 10 enclosures, when properly installed and maintained, are designed to contain an internal explosion without causing an external hazard. Type 8 enclosures are designed to prevent combustion through the use of oil-immersed equipment. Type 9 enclosures are designed to prevent the ignition of combustible dust.

As discussed in 30 CFR, *Mine Safety and Health Administration*, hazardous locations (other than in mines) are classified according to the flammability or combustibility of the materials that may be present, as well as the likelihood that a flammable or combustible concentration is present. For definitions and classifications, see the NEC, Article 500, and NFPA 497M, *Classification of Gases, Vapors, and Dust for Electrical Equipment in Hazardous Classified Locations*. Descriptions and tests in NFPA 497M cover equipment that is suitable for installation in locations classified as Division 1 or 2. In Division 2 locations, other types of protections and enclosures for non-hazardous locations may be installed if the equipment does not constitute a

source of ignition under normal operating conditions. See the specific sections of Articles 501 through 503 of the NEC.

Intrinsically safe equipment (not capable of releasing sufficient electrical or thermal energy under normal or abnormal conditions to cause ignition of specific hazardous atmospheres) may be installed in any type of enclosure otherwise suitable for the environmental conditions expected. See ANSI/UL 913, *Intrinsically Safe Apparatus and Associated Apparatus for Use in Class I, II, III, Division I, Hazardous (Classified) Locations* for detailed requirements.

Purged and pressurized equipment should be installed in enclosures suitable for non-hazardous locations. Hazards may be reduced or eliminated by adequate positive pressure ventilation from a source of clean air in conjunction with effective safeguards against ventilation failure. See NFPA 496, for detailed requirements.

6.5.1 Type 7 Enclosures

Type 7 enclosures are designed for indoor use in locations classified as Class I Groups A, B, C, or D as defined in the NEC.

6.5.1.1 Description and Application

Type 7 enclosures shall^{6.65} be capable of withstanding the pressures resulting from an internal explosion of specified gases and containing such an explosion sufficiently that an explosive gas-air mixture in the atmosphere surrounding the enclosure is not ignited. Enclosed heat-generating devices shall^{6.65} not cause external surfaces to reach temperatures capable of igniting explosive gas-air mixtures in the surrounding atmosphere. Enclosures shall^{6.65} meet explosion, hydrostatic, and temperature design tests.

6.5.1.2 Features and Test Criteria

When completely and properly installed, Type 7 enclosures:

1. Provide to a hazardous gas environment a degree of protection from an internal explosion, or from the operation of internal equipment.
2. Do not develop external surface temperatures that exceed prescribed limits for the specific gas corresponding to the atmospheres for which the enclosure is intended when internal heat-simulating equipment is operated at rated load.
3. Withstand a series of internal explosion design tests:
 - a. That determine the maximum pressure effects of the gas mixture; and
 - b. That determine propagation effects of the gas mixtures.
4. Withstand, without rupture or permanent distortion, an internal hydrostatic design test based on the maximum internal pressure obtained during explosion tests, and on a specified safety factor.
5. Are marked with the appropriate class and groups for which they have been qualified.

6.5.2 Type 8 Enclosures

Type 8 enclosures are designed for indoor or outdoor use in locations classified as Class I Groups A, B, C, or D, as defined in the NEC.

6.5.2.1 Description and Application

Type 8 enclosures and enclosed devices are arranged such that all arcing contacts, connections, and any parts that could cause arcing are immersed in oil. Arcing is confined under the oil such that it does not ignite an explosive mixture of the specified gases in internal spaces above the oil or in the atmosphere surrounding the enclosure. Enclosed heat-generating devices shall^{6.66} not cause external surfaces to reach temperatures capable of igniting explosive gas-air mixtures in the surrounding atmosphere. Enclosures shall^{6.66} meet operation and temperature-design tests. Enclosures intended for outdoor use shall^{6.66} also meet the rain test described below.

6.5.2.2 Features and Test Criteria

When completely and properly installed, Type 8 enclosures:

1. Provide, by oil immersion, a degree of protection to a hazardous gas environment from operation of internal equipment.
2. Do not develop surface temperatures that exceed prescribed limits for the specific gas corresponding to the atmospheres for which the enclosure is intended when internal equipment is at rated load.
3. Withstand a series of operation design tests with oil levels arbitrarily reduced and with flammable gas-air mixtures introduced above the oil.
4. When intended for installation outdoors, exclude water when subjected to a water spray design test simulating a beating rain.
5. Are marked with the appropriate class and groups for which they have been qualified.

6.5.3 Type 9 Enclosures

Type 9 enclosures are designed for indoor use in locations classified as Class II Groups E or G, as defined in the NEC.

6.5.3.1 Description and Application

Type 9 enclosures shall^{6.67} prevent the entrance of dust. Enclosed heat-generating devices shall^{6.67} not cause external surfaces to reach temperatures capable of igniting or discoloring dust on the enclosure or igniting dust-air mixtures in the surrounding atmosphere. Enclosures shall^{6.67} meet dust-penetration and temperature-design tests and prevent aging of gaskets (if used).

6.5.3.2 Features and Test Criteria

When completely and properly installed, Type 9 enclosures:

1. Provide a degree of protection to a hazardous dust environment from operation of internal equipment.
2. Do not develop surface temperatures that exceed prescribed limits for the group corresponding to the atmospheres for which the enclosure is intended when internal equipment is operated at rated load.
3. Withstand a series of operation design tests while exposed to a circulating dust-air mixture to verify that dust does not enter the enclosure and that operation of devices does not cause ignition of surrounding atmosphere.

4. Are marked with the appropriate class and groups for which they have been qualified.

6.6 UNDERGROUND FACILITIES

Underground facilities consist of electrical equipment and wiring installed in underground locations. Working conditions underground can present hazards to electrical workers which are different from those presented above ground. This section aids in dealing with such problems.

Note: DOE does not engage in "mining," as it relates to the extraction of minerals for profit. However, the codes related to mining (30 CFR 57, *Safety and Health Standards Underground Metal and Nonmetal Mines*, 75, *Mandatory Safety Standards Underground Coal Mines*, and 77, *Mandatory Safety Standards, Surface Coal Mines and Surface Work Areas of Underground Coal Mines*) should be followed, where applicable, along with the OSHA regulations set forth in 29 CFR 1910 and 1926.

Electrical work in support of construction of mines, shafts, and underground utilities shall^{6.68} be performed by qualified workers who must meet the requirements in Section 2.7, 30 CFR 75.153, *Electrical work; qualified person*, and 77.103, *Electrical work; qualified person*. Only those workers shall^{6.68} install equipment and conductors within the construction activity.

Once construction of the underground facilities is completed, all wiring used for construction activities should be removed and permanent wiring installed in accordance with 29 CFR 1910, Subpart S, and the NEC as applicable. When the work is not covered by these codes, as referenced, the applicable paragraphs of 30 CFR 57, 75, and 77 prevail.

Electrical equipment and conductors must be used in a manner that prevents shocks and burns to people. Should electrical equipment and conductors present a hazard to people because of improper installation, maintenance, misuse, or damage, the equipment and conductors shall (30 CFR 57.14100) be tagged out and/or locked out as a hazard until fixed. All electrical equipment and conductors shall (29 CFR 1910.7) be chosen and situated in environments conducive to their design and intended use, or as tested by an NRTL for the purpose intended.

The voltage of bare conductors, other than trolley conductors, that are accessible to contact by people shall not exceed 40 V per 30 CFR 77.515 and 48 V per 30 CFR 57.12012. Electrical equipment and conductors, other than trailing cables, shall (29 CFR 1910.304(f)(2)(ii)) be protected against overloads and short circuits by fuses or automatic interrupting devices.

Adequate clearance between equipment and bare overhead conductors shall be maintained in accordance with 29 CFR 1910.303, 30 CFR 57.12071, and 30 CFR 77.807-2. Conductors not being used to supply power to electrical equipment shall be de-energized and removed from their power supply or have their power supply locked out and tagged out in accordance with 29 CFR 1910.147 and 29 CFR 1910.333. All exposed ends shall be insulated per 29 CFR 1910.303(c)(3)(i).

Access inspection doors and cover plates on electrical equipment and junction boxes shall be kept in place at all times, except during testing, and repair per 30 CFR 57.12032 and 30 CFR 77.512. Visible signs warning of danger shall be posted at all substations, switch centers, and control centers to warn people against entry unless they have been authorized to enter and perform duties in these locations per 29 CFR 1910.303 (h)(5)(iii)(B), 30 CFR 57.12019 and 30 CFR 77.511.

6.6.1 Work on Electrical Equipment and Circuits

Before any work is performed on electrical equipment or circuits, the power source or sources shall be de-energized, unless power is a necessary part of the work procedure, per 30 CFR 57.12016, 30 CFR 75.511 and 30 CFR 77.501. In addition, the following rules apply for energized work:

1. Power-cable plugs and receptacles for circuits greater than 150 V potential to ground should not be connected or disconnected under load unless they are of the load-break type. Energized power cables in excess of 150 V potential to ground should be handled in accordance with 29 CFR 1910.331. Care should be taken to prevent damage or shock and burn from the energized cable.
2. Proper tools shall be used to remove or install fuses to protect people from shock or burns per 30 CFR 57.12036, 30 CFR 57.12037, 30 CFR 75.705-9, and 30 CFR 77.704-9.
3. All safety-related electrical work practices covered by the provisions in 29 CFR 1910.331 through .335 should be followed.
4. Exposed electric connections or resistor grids not protected by location should be insulated unless impractical. In this case, guarding shall be installed to prevent accidental contact by people or equipment per 30 CFR 77.510.
5. Communication conductors shall be installed in accordance with 30 CFR 57.12010 and 75.516-2.
6. Lights and lamps shall be properly guarded if they pose a hazard (30 CFR 57.12034) and shall be kept away from combustible material (30 CFR 75.522-1).

6.6.2 Power Cables and Conductors

Cables and insulated conductors shall be protected against physical damage, adverse environmental conditions, and failure of adjacent mechanical equipment (30 CFR 57.12004, 30 CFR 75.516.2, and 30 CFR 77.604).

Per 30 CFR 77.503-1, electric conductors shall be of a size and current-carrying capacity to ensure that a rise in ambient temperature does not exceed the rating of the insulation and conductors. The capacities of electric conductors supplying electrical equipment shall be in accordance with the tables set forth in the NEC. In the case of medium- or high-voltage cable, the manufacturer's ratings shall not be exceeded.

Splices, terminations, and repairs of electric conductors and power cables shall be permitted and shall conform to the requirements expressed in 30 CFR 57.12013, 30 CFR 75.514, 30 CFR 75.604, 30 CFR 75.810, 30 CFR 77.504, 30 CFR 77.602, 30 CFR 77.906 and 29 CFR 1910.303(c).

Surge arresters and lightning protection are required for underground facilities and shall conform to the requirements found in 30 CFR 57.12069 and 30 CFR 75.521. These same requirements state that lightning arresters shall be inspected for damage, at least annually, or after each electrical storm.

According to requirements expressed in 30 CFR 57.12083, power cables and insulated conductors in shafts and bore holes shall be supported with structures and guy wires meeting the specified requirements..

6.6.3 Trailing Cables

Trailing cables used in electrical systems of mines shall meet requirements expressed in 30 CFR 57.12038, 30 CFR 75 Subpart G, and 30 CFR 77, Subpart G.

Requirements for overcurrent protection of each ungrounded conductor shall be those expressed in 30 CFR 57.12003, 30 CFR 75 Subpart G, and 30 CFR 77, Subpart G. According to these requirements, each trailing cable of portable and mobile equipment shall have short-circuit and ground fault protection for each ungrounded conductor. Protective devices shall safely interrupt all ungrounded conductors under fault conditions.

Rules for installation of trailing cables are found in 30 CFR 57.12006 and 30 CFR 57.12007. According to these requirements, trailing cables shall be attached to equipment so that strain on electrical connections does not occur and damage to cable jacket and internal conductor insulation is prevented. Portable distribution boxes are permitted to be used, but shall meet the requirements in 30 CFR 57.12006 and 30 CFR 57.12007. Trailing cables and power conductors shall be protected against physical damage from mobile equipment by using bridges, trenches, or suspension from the mine roof.

Disconnecting devices for trailing cables shall be equipped with means for attaching a padlock for lockout/tagout purposes per 30 CFR 57.12016, 30 CFR 57.12017, 30 CFR 75.511, and 30 CFR 77.501.

6.6.4 Trolley Circuits for Track Haulage

Trolley wires and exposed trolley-feeder wires shall be installed and maintained in accordance with the requirements in 30 CFR 57.12050, and 30 CFR 57.12086.

Trolley wires and trolley-feeder wires shall be protected against overcurrent in accordance with the requirements of 30 CFR 57.12001 and 30 CFR 75.1001.

Track serving as the trolley circuit return shall be bonded or welded, in accordance with the requirements of 30 CFR 57.12042. Energized trolley wires and exposed trolley-feeder wires shall be guarded in places where accidental contact with them is possible. This includes areas where supplies are stored, loaded, or unloaded.

7.0 REQUIREMENTS FOR SPECIFIC EQUIPMENT

The electrical safety requirements for specific equipment are determined by the following standards:

1. NFPA 70, *National Electrical Code*
2. 29 CFR 1910, *Occupational Safety and Health Standards*
3. 29 CFR 1926, *Safety and Health Regulations for Construction*
4. NFPA 70E, *Standard for Electrical Safety in the Workplace*

29 CFR 1910 and 29 CFR 1926 frequently reference other safety guidelines for design, operation, and maintenance. Such other guidelines comprise ANSI, ASTM, and IEEE specifications and information derived from various engineering sources or equipment manufacturer association standards. The NEC reflects wiring and installation requirements that provide for an installation that is essentially free from hazard, but not necessarily efficient, convenient, or adequate for good service.

7.1 CONVEYING SYSTEMS

Conveying systems are used to move materials, goods, etc., from one place to another. Because of their conditions of use, they are usually classified in service applications as intermittent duty.

7.1.1 Electrical Design Criteria

Electrical design criteria should be closely coordinated with the architect, structural engineer, fire protection engineer, mechanical engineer, and electrical safety engineer to ensure that all discipline requirements are coordinated and met.

Factory and field performance tests and control and wiring diagrams should be specified in the purchase order or contract because they are not otherwise provided by the factory. Acceptance tests conducted by the factory representative, qualified independent inspector, or engineer are recommended. Tests conducted by organizations such as UL and Factory Mutual Engineering Corporation are also acceptable.

ANSI and the Crane Manufacturers of Association of America (CMAA) standards should be carefully reviewed to ensure that all applicable safety requirements are covered in the specifications.

The designer should specify the following requirements:

1. Available system voltage;
2. Control voltage;
3. The motor is constructed for the specific application;
4. Motor horsepower, service factor, insulation class, and time ratings are sufficient to meet the load requirements;
5. Working clearances and space requirements; and
6. Disconnecting means and other NEC requirements.

7.2 CRANES AND HOISTS

The most significant factor in crane and hoist safety, after structural integrity, is electrical safety. Referenced standards support this fact, either directly or indirectly, by the amount of definition and space provided for electrical systems' controls, operations, and maintenance.

7.2.1 NEC General Requirements

Basic installation and wiring safety requirements for cranes and hoists are given in NEC Article 610. Electrical designers and maintenance personnel should thoroughly understand these requirements and their intent. Some of the more significant requirements are the following:

1. Cranes and hoists operated in hazardous (classified) locations shall^{7.1} conform to NEC Article 500.
2. When the crane is operated above readily combustible materials, the resistors shall^{7.2} be located in a well-ventilated cabinet constructed of non-combustible material and constructed such that they do not emit flames or molten metal. See the exception (and requirements) that applies to certain cabinets made of noncombustible materials.
3. Cranes and hoists operating on electrolytic cell lines have special requirements, as given in NEC 668.
 - a. Grounding is not required for conductive surfaces of cranes and hoists that enter the working zone of a cell line, and the parts that come in contact with an energized cell, or attachments, shall^{7.3} be insulated from ground.
 - b. Remote controls that may introduce hazardous conditions into the cell line working zone shall^{7.4} employ one or more of the following:
 - i. An isolated and ungrounded control circuit in compliance with NEC Section 668.21(a);
 - ii. A non-conductive rope operator;
 - iii. A pendant pushbutton with either non-conductive support and surfaces or ungrounded exposed surfaces; or
 - iv. A radio.

7.2.2 Disconnecting Means

The disconnecting means provided for cranes and hoists may consist of two or more lock-open-type motor circuit switches or circuit breakers. Article 610, Part IV, of the NEC, *Disconnecting Means*, and the installation and operating plans should be studied carefully to determine the disconnecting means requirements and locations. The two basic disconnects to consider are:

1. The runway conductor (conductors run along a crane runway for power or control) disconnect shall^{7.5} be installed in accordance with NEC 610.31; and
2. The crane and hoist disconnect that shall^{7.6} be provided in the leads from the runway contact conductors or other power supply in accordance with NEC 610.32.

An additional control switch or a remote control switch is required^{7.6} if the second disconnecting means is not accessible to the operator (see Fig. 7-1). A monorail hoist does not require^{7.6} a disconnecting means in the leads to the hoist machinery if it is controlled from the floor, as long as it is within view of the power supply disconnect, and if there is no work platform provided to service the hoist machinery (see Fig. 7-2).

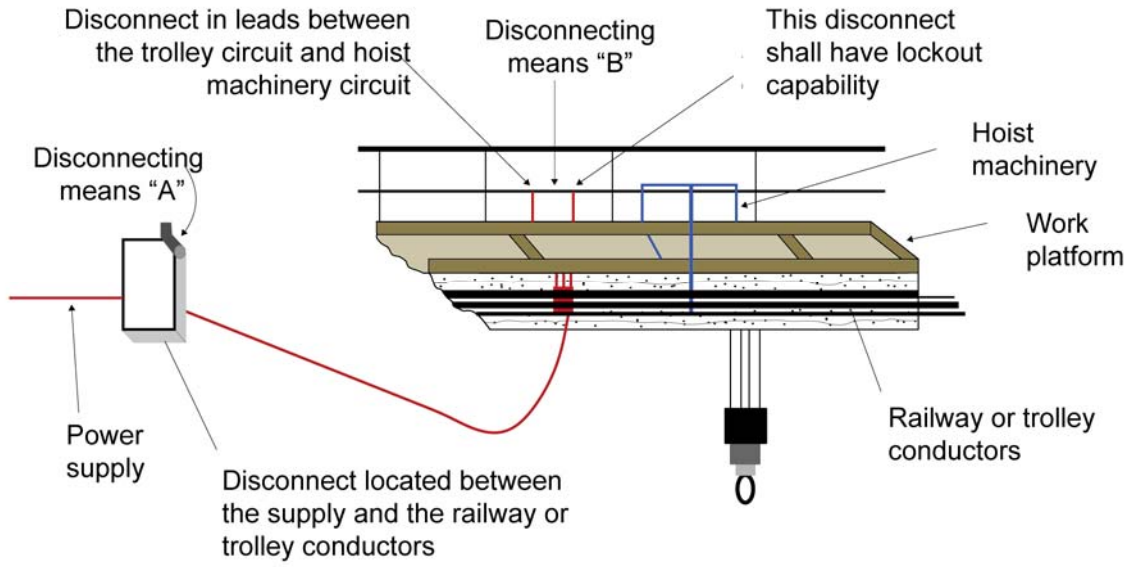

Fig. 7-1. Additional control switch or a remote control.

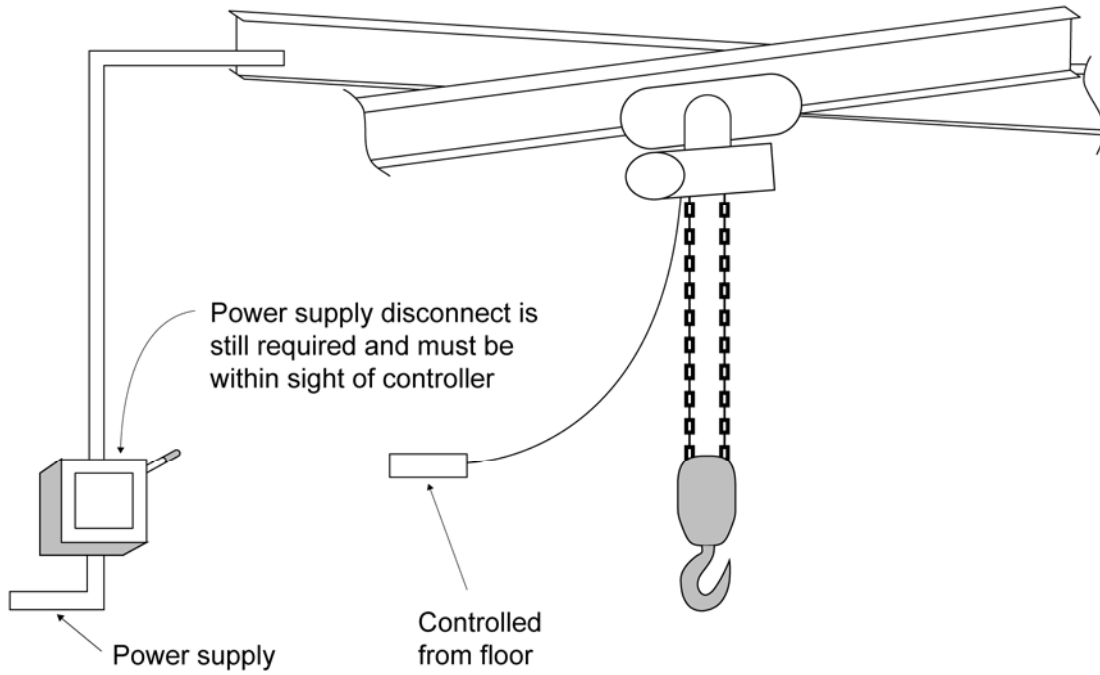

Fig. 7-2. Control switch without second disconnect.

7.2.3 Grounding

NEC grounding requirements consider the crane or hoist with all its associated equipment, including electrical equipment, as a single piece of equipment. Therefore, all the conductive component parts shall^{7.7} be bonded together so that the entire crane or hoist is grounded in compliance with NEC Article 250, and NEC Article 610. Metal-to-metal contact is required between all surfaces, including the trolley wheels and bridge. If any such surfaces are painted or otherwise insulated, a separate bonding conductor is required.

The trolley frame and bridge frame shall^{7.7} not be considered as electrically grounded through the bridge and trolley wheels and its respective tracks. A separate bonding conductor shall^{7.7} be provided.

The bonding of all conductive surfaces by metal-to-metal contact is not to be considered as the EGC for the electrical equipment (motors, motor controllers, lighting fixtures, transformers, etc.) on the crane or hoist. The equipment ground conductors that are run with the circuit conductors shall^{7.8} comply with NEC Article 250.

7.2.4 Control

A limit switch is required^{7.9} to prevent the load block from passing the safe upper travel limit on all hoisting mechanisms.

7.2.5 Clearances

In the direction of live parts, the working space clearance is 2.5 feet, and doors enclosing live parts that may require service or maintenance shall^{7.10} open at least 90 degrees or be removable.

7.2.6 OSHA and NEC Requirements

29 CFR 1910.179 and NEC Article 610, Part F, provide additional electrical requirements derived from ANSI and other standards. Significant requirements are the following:

1. Control circuit voltage shall^{7.11} not exceed 600 V AC or DC. Pendant pushbutton voltage shall^{7.12} not exceed 150 V AC or 300 V DC.
2. Support shall^{7.13} be provided for pendant multiconductor cables.
3. Electrical systems for cranes and hoists shall^{7.14} provide a fail-safe operation. When power fails, all motors shall^{7.15} be automatically disconnected so that they do not resume operation when the power comes back on. Automatic cranes shall^{7.14} not commence motion automatically when the power comes on after an outage. Pendant pushbuttons shall^{7.16} be returned to the off position when pressure is released. When the signal from a remote controller fails, all motion shall^{7.17} stop.

7.2.7 Maintenance and Operations

It is important to have a comprehensive electrical maintenance program for cranes and hoists. Every electrical part and circuit plays a critical operational safety role and shall^{7.18} be checked and serviced at the frequency and in the manner specified by OSHA, CMAA, ANSI, as well as the manufacturer's manual. Required weekly, monthly, and semiannual tests and required record-keeping are contained in ANSI B-30 and CMAA documents.

The basic references for safe operation and maintenance of cranes and hoists are contained in sections of 29 CFR 1910.179 and 29 CFR 1926.1501.

7.2.8 Documented Maintenance

Maintenance checklists and schedules in compliance with OSHA, owner's manuals, and manufacturer's requirements for the specific equipment shall^{7.18} be provided, as required. Weekly, monthly, and semiannual inspections shall^{7.19} be conducted, and comments and condition of the inspected part shall^{7.20} be documented.

The recommended frequencies of inspections vary in accordance with application, usage, and authority. Frequent inspection and periodic inspection are defined by OSHA as daily to monthly and 1 to 12 months, respectively. Typical inspection frequencies for electrical equipment of cranes and hoists are as shown in Table 7-1.

Weekly	Monthly	Semiannually
Brakes	Control Operations	Motors
Pushbuttons	Collectors	Control Panel
Master	Resistors	
Switch	Conductors	
Mainline		
Disconnect		
Warning		
Device		

Table 7-1. Inspection frequencies for components of cranes and hoists.

The inspection records should provide an ongoing safety assessment of the equipment and be used to predict repair-part replacement. The inspector should date and initial all inspections.

7.2.9 Mechanical Elevating and Rotating Equipment

The primary electrical safety concern is working in proximity to live and unguarded electrical overhead lines by un-insulated equipment. Unless these lines are visibly grounded at the point of work and the owner of the lines indicates they are de-energized, barriers or insulating protective material shall^{7.21} be installed to prevent worker contact with them. The following clearances shall^{7.22} be maintained between equipment and electrical overhead lines:

1. Lines 50 kV or below: 10 feet between the lines and any part of the equipment or load, except when in transit; and
2. Lines over 50 kV: 10 feet plus 0.4 inch for every 1 kV above 50 kV.

In locations and situations where it is possible the operator may have difficulty observing that these clearances are being maintained, someone shall^{7.23} be designated to monitor the clearances and provide the operator with timely warning before contact can be made. The use of cage-type boom guards, insulating links, or a proximity sensor should not alter the electrical safety requirements of 29 CFR 1910.269(p)(4) and 29 CFR 1926.550, even if these devices are required. (See Fig. 7-3.)

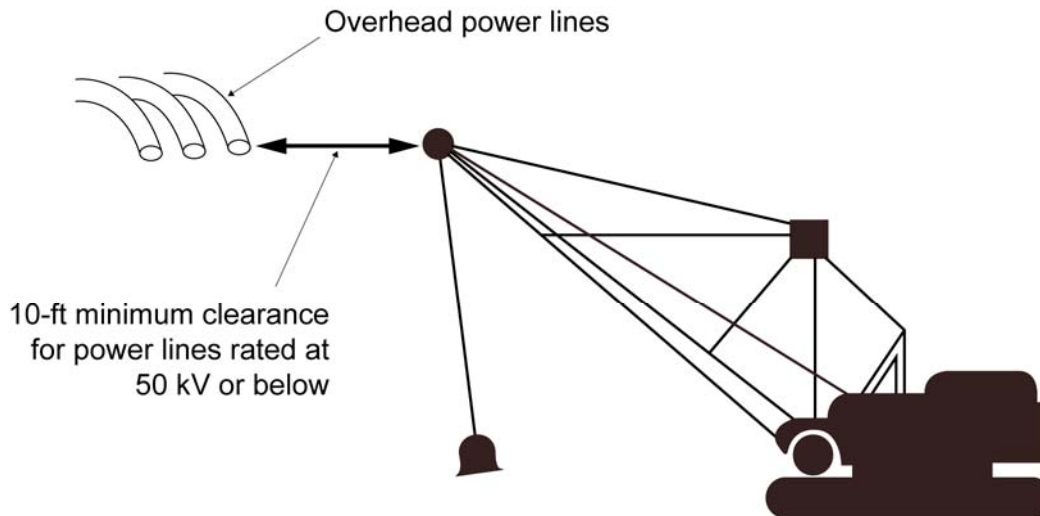

OSHA Sections 29 CFR 1910.269(p)(4) and 1926.952 (b)

Fig. 7-3. Clearance distances between equipment and overhead lines.

7.3 ELEVATORS AND ESCALATORS

Elevators and escalators are used to move people. Elevators are also used to move materials. Design, installation, inspection, and maintenance activities warrant specialized knowledge for safe operation and use.

7.3.1 Codes and Standards

A comprehensive electrical safety program for elevators and escalators can be achieved through the application of the correct codes and standards. All elevators are required to be constructed, installed, and maintained in accordance with ANSI/ASME A17.1, *Safety Code for Elevators and Escalators*. Reference standards include NFPA 70 for the electrical equipment wiring. These standards reflect the interrelated roles of electrical design, maintenance, and fire protection in the electrical safety process.

7.3.2 Design Specifications

The electrical designer should provide for the installation requirements of Article 620 of the NEC, as well as the ANSI/ASME A17.1 requirements for signaling, automatic fire protection, and emergency power as required. The manufacturer should provide the required fire service key switches, audible alarm devices, and internal wiring up to the terminal strips in the elevator control panel.

7.3.2.1 Conductors

Hoistway door conductors from the door interlocks to the hoistway riser shall^{7.24} be flame retardant, suitable for a temperature of at least 200°C, and Type SF or equivalent. See NEC Table 400.4 of the NEC for approved types of elevator cables and Note 7 to NEC Table 400.4 concerning special requirements for traveling control and signal cables. Operating control and signal cable conductors may be as small as #24 AWG. Traveling cable conductors shall^{7.25} be #20 AWG or larger.

7.3.2.2 Disconnecting Means

The disconnecting means requirements for elevators and escalators are both specific and extensive, requiring careful study of the codes and installation plans during design, acceptance testing, and routine inspections. Some of the basic requirements of NEC 620.51 are the following:

1. There shall^{7.26} be a single means of disconnecting all ungrounded conductors to the main power supply of each unit.
2. A single elevator or escalator, with multiple driving machines, shall^{7.26} have one disconnecting means to disconnect the motors and control valve operating magnets.
3. When there is more than one driving machine in a machine room, the disconnecting means shall^{7.27} be labeled.
4. The disconnect shall^{7.28} be a fused motor circuit switch or circuit breaker capable of being locked open.
5. The disconnect shall^{7.29} not be provided with a means of being operated from a remote location.
6. A circuit breaker disconnecting means shall^{7.29} not be opened automatically by a fire alarm system, except as allowed by NEC.
7. The within-sight rule applies to all elevator equipment disconnects. Specific locations are given for elevators with or without field control.
8. The disconnecting means shall^{7.30} be installed in a location that is readily accessible to only qualified persons.

When power from more than one source is used for single- or multiple-car installations, a separate disconnect shall (NEC 620.52) be provided for each source. These disconnects shall (NEC 620.52) be in sight of the equipment supplied, and warning signs shall (NEC 620.52) be placed on or adjacent to the disconnect and shall (NEC 620.52) read, *Warning: Parts of the control panel are not de-energized by this switch.*

Lighting circuits for each elevator shall (NEC 620.53) have a disconnect switch in the equipment room labeled for the car it serves and lockable in the open position.

7.3.2.3 Motors

Elevator and escalator motors are considered as intermittent duty. This allows them to be protected by the OCDP supplying the power for the branch circuit, which is selected by the percentages in NEC Table 430.22 times the full load current of the motors. For example: What is the load for a 15-minute rated 40-HP, 460-V, three-phase motor used as a freight elevator motor?

- Step 1: Finding full load current — NEC Table 430.150
40 HP = 52 A
- Step 2: Finding demand factors — NEC Table 430.22 (a)
15 minute rated = 85%
- Step 3: Calculating load
52 A x 85% = 44.2A
- Answer: Load is 44.2 amps.

7.3.2.4 Grounding

All metal raceways and cables, types metal clad (MC), mineral insulated (MI), or AC, shall^{7.31} be bonded to the metal frame of the car. All elevator equipment including metal enclosures for electric devices on the car shall^{7.32} be bonded in accordance with NEC Article 250.

7.3.2.5 Overspeed Protection

Overspeed protection for overhauling and underhauling is required, as are motor-generator overspeed requirements that shall comply with NEC 430.89, *Speed Limitation*. However, these requirements are a part of the more extensive requirements of ANSI/ASME A17.1 for electrical safety devices, which warrant scrutiny by designers, maintenance personnel, and inspectors.

7.3.3 Emergency Power

Emergency power requirements are governed by ANSI/ASME A17.1, Section 2.26.10 and 2.27.25, which require that the regenerative power of an overhauling elevator prevents the elevator from attaining the lesser of the governor tripping speed or 125% of the rated speed. If the elevator power system cannot absorb this power, a load should be provided on the load side of the elevator power disconnect switch. If an emergency power supply is designed to operate only one elevator at a time, the energy absorption means may be located on the line side of the disconnect. Other building loads that may be supplied by the emergency power source may not be considered as absorbing regenerated energy unless they use the emergency power source as normal power. Refer to Article 620, Part X, of the NEC, *Overspeed*, for the installation requirements covering these requirements.

7.3.4 Design

In addition to the NEC, elevator and escalator requirements, there are numerous electrical requirements for facility designers in ANSI/ASME A17.1 and A17.3. The designer in checking submittal drawings from the manufacturer can use A17.1. ANSI/ASME A17.3 provides the safety requirements for existing elevators and escalators and should be referenced when existing installations are to be modified or to determine which modifications should be made to existing installations and equipment to maintain optimum safety. Typical key electrical requirements from ANSI/ASME A17.1 that the designer should control, over and above those from the NEC, include:

1. Access to elevator equipment is to be controlled and limited to authorized persons.
2. Elevator equipment cannot share space with other building equipment except when the elevator equipment is separated from other equipment, enclosed by a rigid wire fence, and provided with a lock that is strictly for that enclosure.
3. Only electrical wiring, including raceways and cables, used directly in connection with the elevator, including wiring for: (a) signals; (b) communication with the car; (c) lighting, heating, air conditioning, and ventilating the car; (d) fire-detecting systems; (e) pit sump pumps; and, (f) heating and lighting the hoist way, may be installed in the hoist way.
4. A minimum lighting level of 200 lux (19 foot candles (fc)) for the equipment rooms and spaces and 541 lux on the floor of the pit is cited. The basis for the specified illumination level should be in accordance with the Illuminating Engineering Society lighting handbook.

5. A stop switch (emergency stop) is necessary in each elevator pit at the access door to the pit. If the pit exceeds 6 feet 7 inches, a second switch is necessary adjacent to the ladder. The two switches are connected in series.
6. Car lighting should consist of a minimum of two lamps to be supplied by a dedicated circuit with a lock-open disconnect in the equipment room.
7. A 115-V, 20-A receptacle shall^{7.33} be provided in all equipment spaces and in the pit.
8. A phase-reversal protection should be provided to ensure that the elevator motor cannot start if the phase rotation is in the wrong direction, or if there is a failure of any phase.
9. Capacitors and other devices whose failure could cause unsafe elevator operation are prohibited. Only devices specified by the NEC or the manufacturer may be installed.

7.3.5 Fire Protection

The electrical designer should coordinate with the manufacturer on the design of the fire protection systems that connect to the elevator control panel. The system is designed to return the car to a designated area (normally the first floor or lobby) in the event of smoke or fire in the equipment area or near the elevators. In that event, the car returns to a designated area where passengers can safely exit the facility. In addition to coordinating car control, the system provides for the shutdown of the electrical elevator equipment prior to operation of the sprinklers and the transmission of the alarm and provides a means for the firefighters to assume manual control of the elevator from the designated area. The specifications for these systems are detailed in ANSI/ASME A17.1.

7.3.6 Inspections and Records

Elevator inspections and recordkeeping are performed in accordance with the local AHJ. The ANSI/ASME A17.2 series of inspectors' manuals provide a guide for performing tests and inspections as well as recommended inspection checklists. In addition to acceptance inspections and tests, the elevator code specifies one- and five-year inspections for electric elevators and one- and three-year inspections for hydraulic elevators.

7.3.6.1 Codes

Elevators should be in compliance with the issue of ANSI/ASME A17.1 in force the date they were installed. If the local authority has adopted ANSI/ASME A17.3, the code for existing installations, elevators should be in compliance with it, except they should not be downgraded to it. When ANSI/ASME A17.3 is in force, it becomes the minimum standard to which installations should adhere, and if existing installations are upgraded in accordance with ANSI/ASME A17.1, Chapter 8, they should also be in compliance with the more stringent requirements of A17.3.

7.3.6.2 Inspector Qualifications

Inspectors should meet the requirements of OSHA and ANSI/ASME QEI-1 and be recognized by the local enforcing authority. Repair and maintenance personnel should be qualified elevator mechanics.

7.4 PORTABLE AND VEHICLE-MOUNTED GENERATORS

Using portable and vehicle-mounted generators to operate electric tools on job sites is permitted under specific conditions, including the manufacturer's owner manual.

7.4.1 Ground Fault Circuit Interrupter

All portable electric generators that supply 15-or 20-A, 120-V receptacles and that are in use, or are available for use, on construction sites shall^{7.34} be used only with either GFCIs or an assured EGC program.

7.4.2 Grounding Portable and Vehicle-Mounted Generators

7.4.2.1 Portable Generators

The frame of a portable generator shall^{7.35} not be required to be connected to a grounding electrode as defined in NEC 250.52 for a system supplied by the generator under the following conditions:

1. The generator supplies only equipment mounted on the generator, cord-and-plug-connected equipment through receptacles mounted on the generator, or both.
2. The normally noncurrent-carrying metal parts of equipment and the EGC terminals of the receptacles are connected to the generator frame.

7.4.2.2 Vehicle-Mounted Generators

The frame of a vehicle shall^{7.35} not be required to be connected to a grounding electrode, as defined in NEC 250.52, for a system supplied by a generator located on this vehicle under the following conditions:

1. The frame of the generator is bonded to the vehicle frame.
2. The generator supplies only equipment located on the vehicle or cord-and-plug-connected equipment through receptacles mounted on the vehicle, or both equipment located on the vehicle and cord-and-plug-connected equipment through receptacles mounted on the vehicle or on the generator.
3. The normally noncurrent-carrying metal parts of equipment and the EGC terminals of the receptacles are connected to the generator frame.

7.5 BATTERIES

Storage batteries are considered a live source and appropriate precautions should be taken when working around them. Information regarding batteries and battery rooms can be found in OSHA, NESC, NFPA 70E Article 240 and 320, NEC 480.

7.5.1 Surrounding Space

Adequate space should be provided around storage batteries for safe inspection, maintenance, testing, and cell replacement. Space shall^{7.36} be left above cells to allow for operation of lifting equipment when required, for addition of water, and for taking measurements.

7.5.2 Location

Storage batteries should be located in a protective enclosure or area accessible only to qualified persons. A protective enclosure can be: a battery room; a control building; or a case, cage, or fence that shall^{7.37} protect the contained equipment and minimize the possibility of inadvertent contact with energized parts.

7.5.3 Ventilation

The battery storage area shall^{7.38} be ventilated by either a natural or powered ventilation system to prevent accumulation of hydrogen. The ventilation system shall^{7.38} limit hydrogen accumulation to less than an explosive level.

7.5.4 Conduit

Because the vapors given off by a storage battery are very corrosive, the wiring should withstand the corrosive action, and special precautions are necessary as to the type of insulation used and the protection of all metalwork. It is stated by their respective manufacturers that a conduit made of aluminum or silicon-bronze is well-suited to withstand the corrosive effects of the vapors in battery rooms. In contrast, if steel conduit is used, it is recommended that it be zinc-coated and kept well-painted with asphaltum paint.

7.5.5 Battery Room

There are no special requirements for the type of fixtures or other electrical equipment used in the battery room, with proper ventilation. (See NEC 480 and Fig. 7-5.)

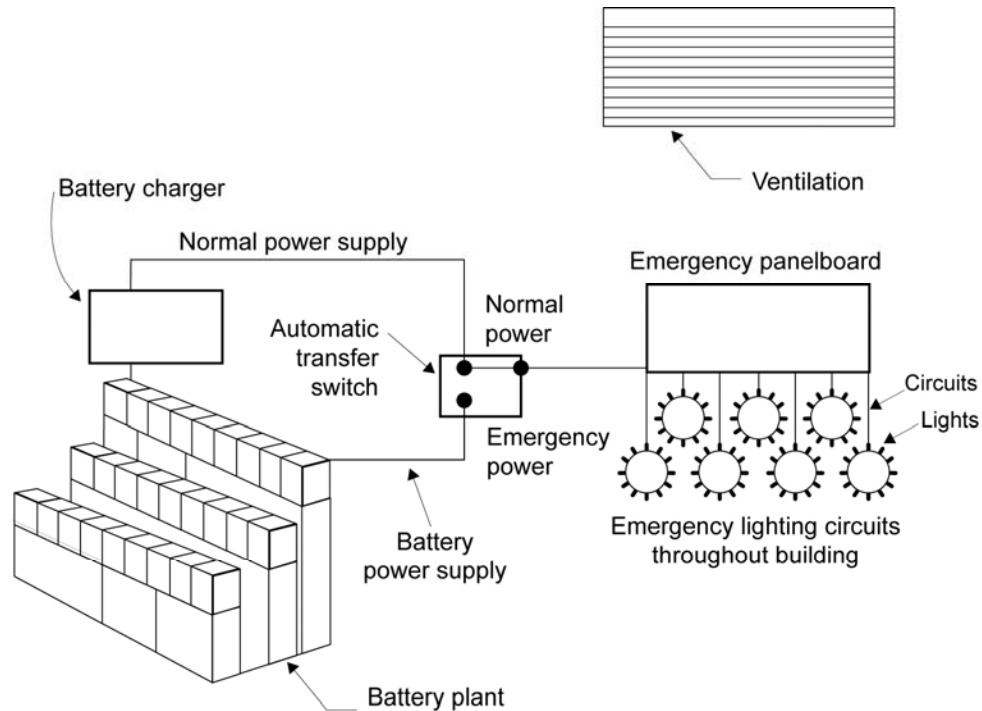

NEC Section 480
OSHA Section 29 CFR 1910.305(j)(7)

Fig. 7-5. Wiring and equipment installed in battery rooms.

7.5.6 Personal Protective Equipment

Those working on or servicing batteries shall^{7.39} use PPE capable of protecting employees from acid splashes. The minimum acceptable PPE shall^{7.40} include acid-resistant gloves, aprons, and chemical-splash goggles. A full-face shield may also be used; however, it should not be worn in place of goggles. When conditions necessitate, PPE should be AR. The use of PPE for wear when servicing batteries shall^{7.41} comply with OSHA requirements. Safety showers and eyewash stations are also required.

7.5.7 Tools

Tools used for working on batteries shall^{7.42} be insulated or non-sparking.

7.5.8 Storage Batteries and Battery Banks

The following subsection covers rechargeable batteries used as a source of electrical energy. This category is not limited to batteries of a particular voltage and energy rating, since the nature of the associated electrical hazards is similar without regard to battery size. The severity of the hazard increases as the battery ratings increase.

7.5.8.1 Types of Hazards

Some of the types of hazards associated with storage batteries and battery banks are as follows:

1. Accidental grounding of one polarity of a battery bank can create a hazardous voltage between the ungrounded polarity and ground.
2. Accidental shorting of the exposed terminals or cables of a battery can result in severe electric arcing (DC arc flash), causing burns and electric shock to nearby personnel.
3. Hydrogen gas generated during battery charging can create fire, explosion, and toxicity hazards.
4. Exposed terminals in a battery bank present electric shock hazards.
5. Batteries, particularly sealed-cell batteries, can explode if they are shorted, or if they are charged at excessively high rates.
6. Electrolytes can be highly corrosive and can produce severe burns to personnel on contact.

7.5.8.2 Design and Construction Criteria

Reliable design and construction criteria for storage areas for batteries are as follows:

1. Battery installations should conform to the requirements in the current edition of the NEC and the NESC.
2. Battery banks should not be grounded, except as required in the NEC. A ground detector should be used to indicate an accidental ground.
3. Batteries should be mounted to allow safe and convenient access for maintenance.
4. Lockable doors should be provided to control access to rooms or enclosures containing battery banks.
5. Approved safety showers and eyewash stations should be provided close to battery banks.

6. Appropriate ventilation for discharges of gas should be provided.
7. In areas where seismic activity is present, the installation should be designed according to local standards.

7.5.8.3 Operating Criteria

Operating criteria are as follows:

1. Maintain battery bank connections that are clean and tight to prevent excessive heating because of contact resistance.
2. Do not repair battery connections when current is flowing. An accidental opening of the circuit could result in a hazardous arcing condition.
3. Clearly post electrical and other hazards of battery banks and emergency first aid information near the equipment.
4. Arrange the battery banks so that temperature stratification does not result in over- or under-charging.

Note: The optimum storage temperature for maximum battery life for lead-acid batteries is 77°F ± 2° (25°C ± 1).

7.5.8.4 VRLA Battery (valve-regulated lead–acid battery)

A VLRA battery, more commonly known as a sealed battery is a lead–acid rechargeable battery. Because of their construction, VRLA batteries do not require regular addition of water to the cells, and vent less gas than flooded lead-acid batteries. The reduced venting is an advantage since they can be used in confined or poorly ventilated spaces. But sealing cells and preventing access to the electrolyte also has several considerable disadvantages as discussed below. VRLA batteries are commonly further classified as:

- Absorbed glass mat (AGM) battery
- Gel battery ("gel cell")

An *absorbed glass mat* battery has the electrolyte absorbed in a fiber-glass mat separator. A *gel cell* has the electrolyte mixed with silica dust to form an immobilized gel.

While these batteries are often colloquially called *sealed* lead–acid batteries, they always include a safety pressure relief valve. As opposed to *vented* (also called *flooded*) batteries, a VRLA cannot spill its electrolyte if it is inverted. Because AGM VRLA batteries use much less electrolyte (battery acid) than traditional lead–acid batteries, they are sometimes called an "acid-starved" design.

The name "valve regulated" does not wholly describe the technology. These are really "recombinant" batteries, which means that the oxygen evolved at the positive plates will largely recombine with the hydrogen ready to evolve on the negative plates, creating water and preventing water loss. The valve is a safety feature in case the rate of hydrogen evolution becomes dangerously high. In flooded cells, the gases escape before they can recombine, making it necessary to add water periodically.

VRLA batteries offer several advantages compared with flooded lead–acid cells. The battery can be mounted in any position, since the valves only operate on overpressure faults. Since the battery system is designed to be recombinant and eliminate the emission of gases on

overcharge, room ventilation requirements are reduced and no acid fume is emitted during normal operation. The volume of free electrolyte that could be released on damage to the case or venting is very small. There is no need (nor possibility) to check the level of electrolyte or to top up water lost due to electrolysis, reducing inspection and maintenance.

Because of calcium added to its plates to reduce water loss, a sealed battery recharges much more slowly than a flooded lead acid battery. Compared to flooded batteries, VRLA batteries are more sensitive to high temperature, and are more vulnerable to thermal run-away during abusive charging. The electrolyte cannot be tested by hydrometer to diagnose improper charging, which can reduce battery life.

8.0 WORK IN EXCESS OF 600 VOLTS

This section applies to work on utility electrical systems on the supply side of the service point. See Appendix B for a definition of service point. Additional information on high-voltage research and development (R&D) work can be found in Section 13 and Appendix D.

Qualified and competent electrical workers perform a variety of tasks with and around higher voltage electricity, electrical equipment, and apparatus. The nature of such work necessitates an understanding of applicable safety policies and rules.

Many electrical hazards and work practices are the same regardless of the voltage involved. However, due to the nature of high-voltage work, there are many hazards and work practices that are specifically related to high-voltage.

8.1 RESPONSIBILITIES FOR SAFETY

This section provides safety guidelines and requirements for carrying out assigned job tasks. It is essential that each employee exercise sound judgment to perform assigned tasks safely. Safety is the responsibility of each employee.

8.1.1 Workers

The greatest responsibility for a worker's safety lies directly with the worker. Workers are responsible for performing their work in a manner that does not endanger themselves, their co-workers, or others in the area and for complying with safety rules and requirements. Workers should not rely solely on the care exercised by another for their protection. Workers are encouraged to contribute to the safety program and bring to the attention of their supervisors or safety representative any condition they believe is unsafe.

Other safety responsibilities of workers include the following:

1. The worker should examine the work area for existing hazards and proceed in a safe manner.
2. When observed in a dangerous situation, fellow workers should be warned in such a manner as to avoid confusing, startling, or suddenly alarming them.
3. Before climbing poles, ladders, or other such structures or before working on scaffolds, workers shall^{8.1} make a careful inspection to determine whether the structures are safe and are properly supported. Workers should not carry anything in their hands while ascending or descending ladders. Small objects or tools may be carried in pockets or pouches. Larger objects, however, should be raised or lowered by use of hand lines or ropes and blocks. Others working nearby or below should remain out of line of the work area in case anything should accidentally be dropped.
4. It is the responsibility of each worker to attend safety meetings. Workers should also make a practice of learning safety information made available to them that helps them perform their work more safely.
5. The worker should report to the supervisor any personal injury, as defined by the facility, as soon as possible.
6. The worker should exercise care and good judgment when lifting heavy material, obtaining help if the object is too heavy or awkward for one person to handle.

7. The worker shall^{8.2} be properly trained in the setup and the operation of insulated bucket trucks, as well as the use of applicable fall protection equipment and other required PPE.

8.1.2 Supervisors

Supervisors are responsible for knowing and implementing applicable safety policies and directives and taking action, as required, to provide for the safety of the personnel and operations they supervise. This includes: taking positive action to determine and reduce, as necessary, the hazards associated with their operations; instructing employees in safe work methods and associated safety requirements; allowing only those employees that are qualified for the work to perform the work; and, ensuring that employees perform their work safely.

Supervisors shall^{8.3} be responsible for the safety of all employees under their supervision. They shall^{8.4} enforce the rules that apply to the hazards involved.

Supervisors shall^{8.4} make certain that each new or transferred employee is instructed in the safe practices pertaining to his or her work.

Supervisors shall^{8.4} ensure that the appropriate employees receive instruction in appropriate emergency techniques, such as CPR, first aid, pole top rescue, and confined space rescue, as warranted by the employee's duties.

Other duties of supervisors include the following:

1. Provide instructions on safe practices for the crew and see that they are followed;
2. Periodically examine supervised employees on their knowledge of the safety rules and approved emergency techniques;
3. Workers shall^{8.5} only be assigned tasks for which they are qualified;
4. Report every injury in the established manner prescribed for the facility;
5. Be responsible for the care and proper use of all protective devices;
6. Be responsible for proper posting of hazardous work areas as a safeguard to those supervised. Under no circumstances shall^{8.6} the supervisor allow work to continue if safety precautions are ignored;
7. Designate a qualified worker to be in charge of work during the supervisor's absence. The supervisor should not leave the job while dangerous work is in progress;
8. Coach and direct employees who are working near exposed, energized wires, equipment, or apparatus; and
9. Prescribe, along with employees, the appropriate PPE when establishing safety-related work practices.

8.2 TRAINING

8.2.1 Employee Training

Employees shall^{8.7} be trained in, and familiar with, the safety-related work practices, safety procedures, and other safety requirements in this section that pertain to their respective job assignments.

Employees shall^{8.7} also be trained in, and familiar with, any other safety practices, including applicable emergency procedures that are not specifically addressed in this section, but are related to their work and necessary for their safety.

8.2.2 Qualified Employee Training

Qualified employees shall^{8.8} be trained and competent in:

1. The skills and techniques necessary to distinguish exposed live parts from other parts of electrical equipment;
2. The skills and techniques necessary to determine the nominal voltage of exposed live parts;
3. The skills and techniques necessary to determine the minimum approach distances corresponding to the voltages to which they are exposed; and
4. The proper use of the special precautionary techniques, PPE, insulating and shielding materials, and insulated tools for working on or near exposed energized parts of electrical equipment.

Training may consist of a combination of classroom and on-the-job type.

8.3 JOB BRIEFINGS

The employee in charge shall^{8.9} conduct a job briefing with the involved employees before the start of each job. The job briefing shall^{8.9}, at a minimum, cover the following subjects: hazards associated with the job, work instructions involved, special precautions, energy source controls, working alone, and PPE requirements.

If the work or operations to be performed during the work day are repetitive and similar, at least one job briefing shall^{8.10} be conducted before the start of the first job of each day or shift. Additional job briefings shall^{8.10} be held if significant changes, which might affect the safety of the employees, occur during the course of the work.

A brief discussion is satisfactory if the work involved is routine, and if the employee, by virtue of training and experience, can reasonably be expected to recognize and avoid the hazards involved in the job. A more extensive discussion shall^{8.11} be conducted if the work is complicated or extremely hazardous, or if the employee cannot be expected to recognize and avoid the hazards involved in the job.

8.4 PERSONAL PROTECTIVE EQUIPMENT AND PROTECTIVE CLOTHING

Employees shall^{8.12} wear appropriate PPE and protective clothing to protect them from hazards of high-voltage apparatus. Employees authorized to work on high-voltage systems shall^{8.12} be completely familiar with the PPE and protective clothing they need for adequate protection while working on such systems. Figure 8-1 presents a depiction of appropriate PPE.

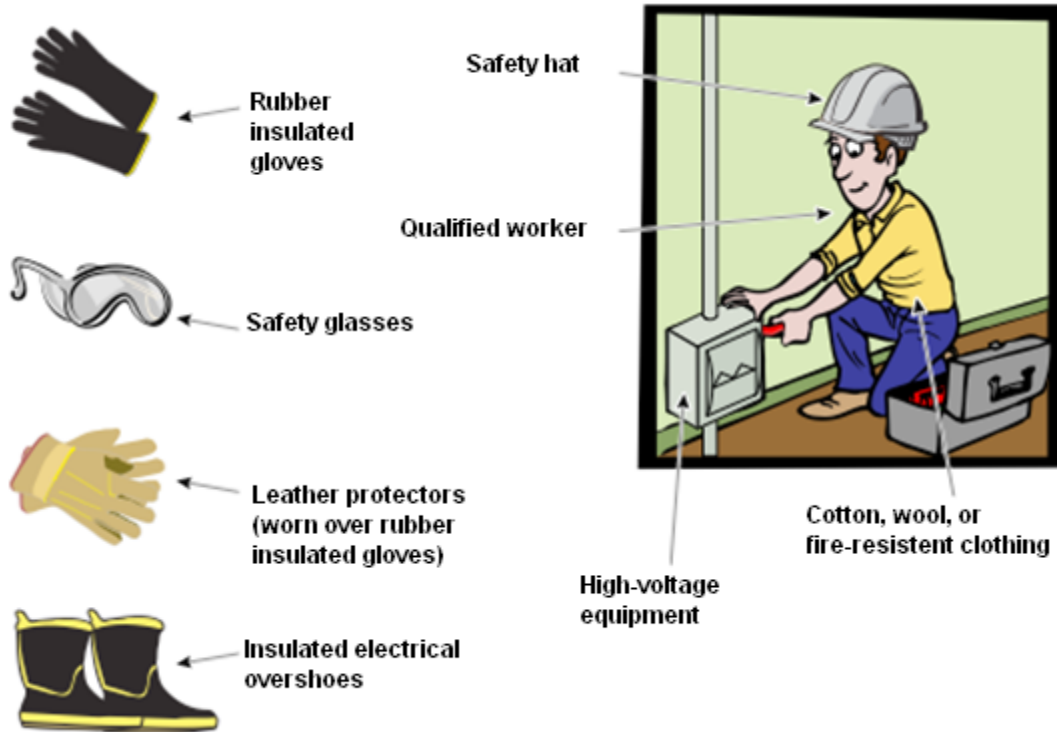

Fig. 8-1. Appropriate PPE.

8.4.1 Shoes

Employees should wear shoes or boots that comply with the requirements of ASTM F-2412, *Standard Test Methods for Foot Protection*. No metal parts should be present in the sole or heel of the shoes where non-conductive shoes are required. Electrical overshoes should be worn where step potential exists.

8.4.2 Hardhats

Workers shall^{8.13} wear approved hardhats when working aboveground on poles, structures, in bucket trucks, buildings or in trees.

Workers shall^{8.13} wear hardhats when working on the ground near poles, structures, buildings, or trees in which work is being done. Workers shall^{8.13} wear hardhats when visiting or observing in areas where overhead work is being done.

8.4.3 Eye Protectors

Whenever eyes are in danger of being injured, workers shall^{8.14} wear safety goggles or other eye protectors meeting ANSI standards. When the work being performed dictates, workers should wear nonmetallic and non-conductive eye protection. Appropriate PPE shall^{8.14} be used to protect workers from arc flash hazards.

8.4.4 Conductive Articles

Workers shall^{8.15} not wear articles such as loose chains, keys, watches, or rings (unless appropriately covered).

8.4.5 Work Gloves

When insulated gloves suitable for high-voltage are not required, other suitable work gloves should be worn while handling materials and equipment.

8.4.6 Work Clothes

Work clothes should be made of natural materials, such as cotton or wool, or fire resistant materials and should have full length sleeves. Sleeves should be rolled down for greatest protection.

8.4.7 Fire-Resistant (FR) Arc-Rated (AR) Clothing

FR AR materials, such as flame-retardant treated cotton, meta-aramid, para-aramid, and poly-benzimidazole fibers provide thermal protection. FR AR fabrics can reduce burn injuries during an arc flash. FR clothing is AR, only if it is labeled with an Arc Thermal Performance Value (APTV) or Energy Break Through value (E_{bt}).

8.4.7.1 General

Standard 29 CFR 1910.269(1)(6)(iii) prohibits use of fabrics that could increase injury when exposed to hazards of flame or electric arcs. Untreated cotton and wool comply if the fabrics do not ignite and continue to burn under the conditions to which the employee could be exposed. ASTM Standards F-1506-94, *Standard Performance Specification for Flame Retardant Textile Materials for Wearing Apparel for Use by Electrical Workers Exposed to Momentary Electric Arc and Related Thermal Hazards*, F1958, *Standard Test Method for Determining the Ignitability of Non-Flame-Resistant Materials for Clothing by Electric Arc Exposure Method Using Mannequins* and F1959, *Standard Method for Determining the Arc Rating of Materials for Clothing* outline the testing procedures to determine how various fabrics react in the presence of an electric arc, using an instrumented manikin or panel. The ASTM standards provide testing procedures that expose untreated and fire-resistant fabrics to electric arcs.

8.4.7.2 Electric Arc Hazards

Electric shock is a widely-recognized hazard and involves current flow through or on the body. Thermal burns from electric arcs are not as well recognized. There is no contact necessary for a burn from an electrical arc and the burns can be severe if the clothing ignites or melts. The hazards to which the employee is exposed also include the clothing breaking open due to the arc pressure blast, the heat from the electric arc and subsequent secondary fires or explosions.

The extent of the employee's injury is dependent on the length of the arc gap, available fault current, duration of the arc, the distance of the employee from the arc, percentage of the body

burned, the employee's age, medical condition, and clothing worn. The proper AR clothing system can protect the employee from a burn injury, or reduce the burn injury effects.

8.4.7.3 Types of Fire Resistant Fabrics

Chemically-dependent fire-resistant fabrics are treated with flame-retardant chemicals added to the fiber or treatments applied to the fabric. These treatments are activated by heat and produce gases that smother the flame. Typically, these fabrics have a definite life, as defined by the manufacturer. This is usually defined by the number of home or commercial washings to which the garment is exposed.

Inherently fire-resistant fabrics, by their composition, do not burn in air. The fire-resistance of this fabric is not affected by washing.

8.4.7.4 Clothing Systems

All clothing worn by affected workers should be considered part of the employees' protective clothing system. This includes AR rainwear, AR cold weather wear and non-melting underclothing. Protective clothing should provide a good functional fit to increase the protection and comfort of the clothing. Multiple layers of flame-resistant outer garments over non-melting clothing could increase the protection, but the system should be tested to determine adequate protection level. Long sleeves and shirts should be fully-buttoned and appropriate neck, head, and hand coverings provided.

8.4.8 Rubber Gloves

The following requirements apply:

1. Rubber gloves shall^{8.16} be of appropriate voltage rating for the work being performed. All rubber gloves shall^{8.16} meet the standards set forth by OSHA 29 CFR 1910.137 and ASTM.
2. Rubber gloves shall^{8.17} be tested at appropriate voltage levels at intervals not exceeding six months beginning from the date of issue.
3. If the insulating equipment has been electrically tested but not issued for service, it shall^{8.16} not be placed into service unless it has been electrically tested within the previous 12 months.
4. Leather glove protectors shall^{8.18} be worn over rubber gloves except where leather protectors are not required by 29 CFR 1910.137 or ASTM F496, *Standard Specification for the In-Service Care of Insulating Gloves and Sleeves*.
5. Rubber gloves should be carried cuff down in a bag, box, or container that is designed for this purpose. Rubber gloves may be kept inside of leather protectors.
6. Rubber gloves shall^{8.19} be visually inspected and field air-tested before use each day, and at other times, if there is cause to suspect damage.
7. Rubber gloves shall^{8.20} be uniquely identified (i.e., serial number or other marking). The results of dielectric tests shall^{8.20} be documented.
8. Rubber gloves shall^{8.21} be wiped clean of any oil, grease, or other damaging substances as soon as possible.

8.4.9 Rubber Line Hose, Hoods, Covers, Sleeves, and Blankets

Linemen's rubber insulating sleeves are worn to provide protection from electric shock and burn to the arm and shoulder areas. They are available in several different thicknesses, lengths, and designs, depending on the maximum voltage they are designed to protect against.

Insulating line hose (flexible hose) is used as an insulating cover for electric conductors to protect against accidental contacts. A lengthwise slit with overlapping sides permits the hose to be placed on conductors easily. It is available in various diameters, lengths, and compositions.

Insulating covers are used in conjunction with line hose to cover an insulator and the conductor attached to it for protection against accidental contact.

Rubber insulating blankets are molded sheets of insulating rubber or synthetic elastomer, usually square or rectangular in shape, designed to cover energized electrical equipment to prevent direct accidental contact by electrical workers.

8.4.10 Live Line Tools

A careful periodic inspection in accordance with ASTM requirements shall^{8.22} be made of equipment used for handling or testing energized lines or equipment. Such tools shall^{8.23} be examined before use each day to make certain they are in good condition.

Particular attention shall^{8.24} be given to preserving the surfaces of fiberglass tools used around electrical equipment, including ladders, pike poles, switch sticks, live-line tools, and insulating platforms.

Insulated tools shall^{8.25} be stored in such a location and in such a manner as to protect it from light, temperature extremes, excessive humidity, ozone, and other injurious substances and conditions.

Suitable containers or racks should be provided to protect the tools from mechanical damage and warping.

Live-line tools should be constructed to meet the wet test from IEEE 516, *Guide for Maintenance Methods on Energized Power Lines*.

8.4.11 Storeroom Storage

Since heat, light, oil, and distortion are natural enemies of rubber, rubber protective equipment should be guarded from these as much as possible.

Gloves should be stored in their natural shape in the leather protector. Keep sleeves flat with the inserts left in. Blankets should be stored flat, hung on pegs by the eyelet, or rolled up. Line hose should be stored in its natural shape.

8.4.12 Truck Storage

The storing of rubber protective equipment on the truck should be planned. If possible, separate compartments should be provided for each class of equipment, and each compartment should be of sufficient size to allow the articles to lie in a natural position. Rubber gloves should be stored in glovebags and hung up. If stored in tool bags or inside boxes, nothing should be piled on top to cause distortion. Gloves should not be stored near vehicle heaters.

Sleeves should be stored flat with inserts rolled up lengthwise, or placed in a tube-shaped bag. Nothing should be placed on top of sleeves or stored near vehicle heaters. Blankets should be rolled up and placed in canisters or protective canvas holders. Do not fold, hold together with tape, pile materials on top of, or store blankets near vehicle heaters.

8.4.13 Placing of Insulating Goods on Conductors

When workers are about to begin work that requires the use of rubber goods, they should climb, or raise the bucket, to a position just below the first line of conductors. When climbing they should then determine their working position and what lines and other conductors should be covered. They should then request the required rubber goods. Rubber goods should be raised in a secure manner. Before proceeding further, the workers should put on the rubber gloves and leather protectors and make certain that they are in good order.

As the workers ascend to their working position, they should cover all conductors that provide a hazard. This should be done from below whenever possible. At no time should workers pass through energized equipment before it is covered with rubber goods (line guards). All conductors and grounds adjacent to working space should be considered, including those near any possible change of position that may be necessary. When line hose is applied to vertical or sagging wires, it should be fastened to the line to prevent its slipping from position. When blankets are used for covering items, such as dead ends, potheads, secondary racks, and transformers, they should be secured by wooden or plastic clamp pins or tie thongs. After the protective equipment has been placed, care should be taken to prevent damage to the rubber from tie wires, spurs, or other objects.

8.4.14 Removing Insulating Goods from Conductors

When the job is completed, the protectors should be removed in the reverse order of installation. Remote conductors are removed first and the wires nearest the workers last. After being detached, the equipment should immediately be lowered to the ground.

8.4.15 Cleaning and Inspecting

After the rubber goods have been lowered to the ground, they should be cleaned and visually inspected before being placed in the carrier compartments of the truck.

8.5 PROTECTIVE GROUNDING OF LINES AND EQUIPMENT

Grounding is the most effective way of protecting electrical workers from electric shock. That is why it is important to ensure that all de-energized lines and equipment are grounded.

8.5.1 Purpose

This section provides information concerning protection for workers repairing, servicing, or working on high-voltage power lines.

8.5.1.1 Reduce the Potential Voltage Differences Across the Worker

The primary function of personal protective grounds is to provide maximum safety for personnel while they are working on de-energized lines or equipment. This is accomplished by making provisions that reduce the potential voltage differences at the work site (voltage differences across the worker) to a safe value in the event that: the line or equipment being worked on is accidentally re-energized; voltages are induced from other energized lines; an energized line falls on the line being worked; or, there is a lightning strike near the line being worked. Equipotential grounding

is the most effective way of protecting employees who are working on high-voltage systems and equipment (see Fig. 8-2).

The personal protective grounds should provide a low-impedance path to ground to ensure prompt operation of the circuit protective devices.

8.5.2 Application

Certain methods and steps shall^{8.26} be exercised when placing grounds and loads to protect workers from high-voltage hazards.

8.5.2.1 De-energized Lines

When an energized line or equipment in excess of 600 V is removed from service to be worked on, it shall^{8.27} be treated as energized until it is de-energized, tagged, locked (if necessary), tested, and grounded.

8.5.2.2 New Construction or Dismantling of Facilities

If isolating devices are not in place and energization is impossible from any source, single-phase grounding is appropriate, acceptable, and safe. If energization is possible by the closure of a jumper or isolating device, shorts and grounds shall^{8.28} be used, unless conductor handling activity makes this impractical or impossible because of line design or construction process.

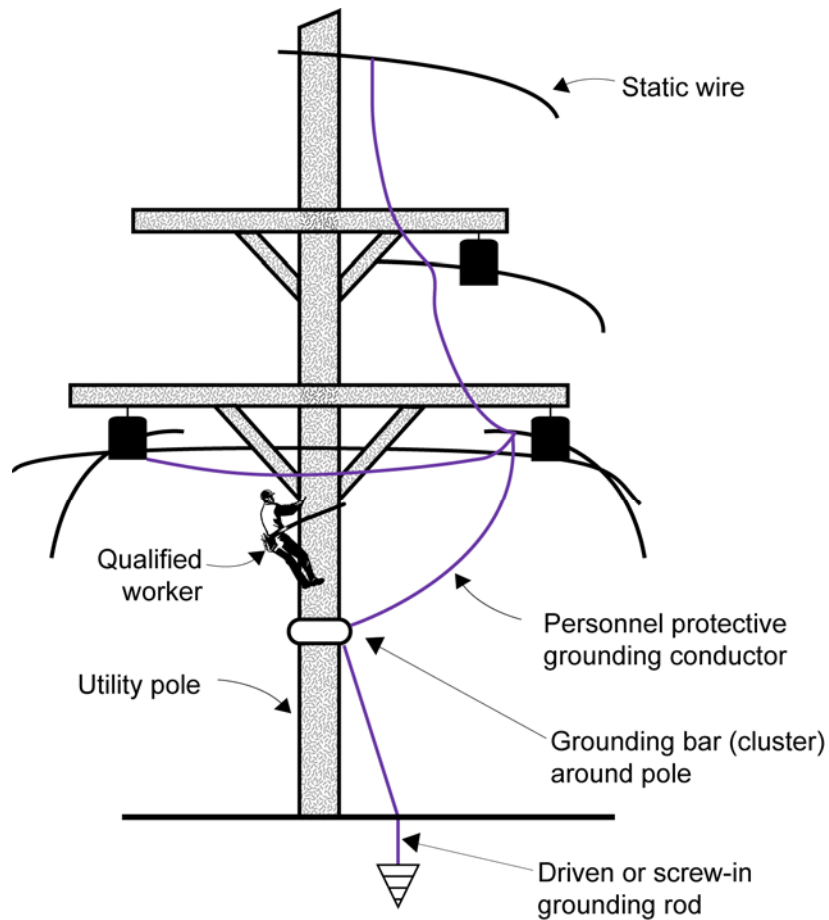

OSHA Sections 29 CFR 1910.269(n) and 1926.954

Fig. 8-2. Equipotential grounding to protect workers.

8.5.2.3 Minimum Approach Distance from Ungrounded Conductors

The minimum approach distances shall^{8.28} be maintained from ungrounded conductors at the work location (Table 8-1). The ground may be omitted if the making of the ground is impractical or the resulting conditions are more hazardous than working on the lines or equipment without grounding. However, all work shall^{8.27} be done as if the line or equipment were energized.

Phase-to-Phase Nominal Voltage (kV)	Distance, Phase to Employee	
	Phase-to-Ground Exposure (ft - in)	Phase-to-Phase Exposure (ft - in)
1 or less	Avoid contact	Avoid contact
1.1 to 15	2-1	2-2
15.1 to 36	2-4	2-7
36.1 to 46	2-7	2-10
46.1 to 72.5	3-0	3-6
72.6 to 121	3-2	4-3
138 to 145	3-7	4-11
161 to 169	4-0	5-8
230 to 242	5-3	7-6
345 to 362	8-6	12-6
500 to 550	11-3	18-1
765 to 800	14-11	26-0

Note 1: These distances take into consideration the highest switching surge an employee can be exposed to on any system with air as the insulating medium and the maximum voltage shown.

Note 2: The clear live line tool distances shall^{8.29} equal or exceed the values for the indicated voltage ranges.

Note 3: See 29 CFR 1910.269, Appendix B for information on how the minimum approach distances were derived.

Table 8-1. AC live-line work minimum approach distance.

8.5.2.4 Visible Three-Phase Short and Ground Required

Visible three-phase short circuiting may be accomplished through conductive parts such as guy wires and unpainted metal tower members, but should not be affected through a grounding mat or other concealed conductors.

8.5.2.5 Ground Circuit

No power disconnect switch, power circuit breaker, transformer, wave trap, or fuse should be part of the protective grounding circuit.

8.5.3 Grounding Equipment

ASTM Committee F-18, *Electrical Protective Equipment for Workers*, has developed and published a consensus standard for protective grounds, ASTM Designation: F-855, *Standard Specifications for Temporary Protective Grounds to be Used on De-Energized Electric Powerlines and Equipment*. This voluntary consensus standard may be used by all federal agencies for procurement purposes. Therefore, grounding cables, clamps, and ferrules purchased should meet all the requirements of ASTM Designation: F-855. Aluminum cables shall^{8.30} not be used for personal grounds.

The grounding of high-voltage lines and equipment provides workers with additional protection from electric shock if grounds are sized, selected, and installed properly.

8.5.3.1 Availability

Grounding cables should be available for use when work is being done on de-energized lines or equipment. See ASTM F-855-09 for information regarding mechanical forces and X/R requirements.

8.5.3.2 Approved Capacity

Grounding cables shall^{8.31} accommodate the maximum fault current to which the cable or equipment might be subjected.

8.5.3.3 Grounding Cables and Hardware

Personal protective grounding cables consist of appropriate lengths of suitable copper grounding cable, with electrically and mechanically compatible ferrules and clamps at each end. In addition, appropriate live-line tools are required^{8.32} for installing and removing the conductor-end clamps to the conductors. Live-line tools are required^{8.32} for attaching ground-end clamps if the grounded system and the worker are at different potentials. Cluster bars provide a low-resistance means of connecting the ground-end clamps. Each of these components is discussed in the following subsections.

8.5.3.4 Grounding Cables

Most of the grounding cables in use today (and available for purchase) are actually manufactured for another purpose – principally as welding cable. These extra-flexible copper cables with jackets are manufactured according to appropriate ASTM standards for both cables and jackets, and can be expected to perform satisfactorily as grounding cables.

8.5.3.4.1 Jackets

Welding cables are nominally insulated at 600 V. When used as grounding cable, the insulation or jacket serves primarily for mechanical protection of the conductor. The flexible elastomer or thermoplastic jackets are manufactured, applied, and tested according to ASTM standards. Black, red, and yellow jackets are usually neoprene rubber compounds, while clear jackets are ultraviolet-inhibited polyvinyl chloride (PVC). All jackets should have the AWG size stamped or printed repeatedly, along the length of the cable. The clear jacket allows easy visual inspection of the conductor for strand breakage, but becomes stiff and hard to handle at low temperatures. The clear jacket splits or shatters at very low temperatures.

8.5.3.4.2 Ferrules

Ferrules should be threaded-stud copper base compression type. Ferrules should have the filler compound vent hole at the bottom of the cable so employees can visually check that the cable is fully inserted into the ferrule. Compound should be used with crimped ferrules. The ferrules should be crimped with the ferrule manufacturer's recommended die. The press should have enough pressure to completely close the die. The area covering the inserted cable jacket should not be compressed. Heat shrink or springs should be installed over a portion of the ferrule to minimize strand breakage caused by bending. In all cases, the manufacturer's recommendations should be followed.

8.5.3.4.3 Handling of Grounding Cable

Personal protective grounds are usually handled and lifted by the cable. However, continuous flexing eventually breaks the conductor strands beneath the jacket. Therefore, employees should minimize the use of sharp bends in the cable.

8.5.3.4.4 Size of Grounding Cable

The size of the grounding cable shall^{8.30} be selected to handle the maximum calculated fault current of the power system or specific portion thereof. The minimum size that shall^{8.30} be used for grounding cables is #2 AWG flexible copper. In larger substations, the maximum available fault current may dictate larger cables. If larger cables are not available, parallel cables (with the appropriate derating factor) may be used.

Most manufacturers and suppliers of grounding cables publish tables to assist the user in selecting the proper cable size for a given fault current. These tables show the maximum fault current capability for several sizes of copper grounding cables.

8.5.3.4.5 Grounding Cable Length

Excessive cable lengths should be avoided. Therefore, slack in the installed cables should be minimal to reduce possible injury to workers. Resistance in the cable increases with cable length, and excessive length could exceed the tolerable voltage drop across the body. Longer than necessary cables also tend to twist or coil, which reduces the effectiveness of the cable.

8.5.3.4.6 Grounding Clamps

Grounding clamps are normally made of copper or aluminum alloys; sized to meet or exceed the current-carrying capacity of the cable; and designed to provide a strong mechanical connection to the conductor, metal structure, or ground wire/rod.

8.5.3.4.6.1 Clamp Types

Clamps are furnished in, but not limited to, three types according to their function and methods of installation:

1. Type I clamps, for installation on de-energized conductors, are equipped with eyes for installation with removable hot sticks.
2. Type III clamps, for installation on permanently grounded conductor or metal structures, have T-handles, eyes, and/or square-or hexagon-head screws.
3. Other types of special clamps are designed for specific applications, such as cluster grounds, underground equipment grounding, and may be made, tested and certified by the manufacturer meeting the requirements of ASTM F-855.

8.5.3.4.6.2 Clamp Jaws

Bus clamps should be furnished with smooth jaws for installation on copper, aluminum, or silverplated bus work without marring the surface. Conductor or metal structure clamps should be furnished with serrations or cross-hatching designed to abrade or bite through corrosion products on surfaces of the conductor or the metal structure being clamped. Several styles of conductor and ground-end clamps have jaws that can be replaced when the serrations have worn. Self-cleaning jaws are recommended for conductor-end clamps used on aluminum or aluminum conductor steel reinforced conductors. Several styles of ground-end clamps are designed with a cup-point set screw, which should be tightened with a wrench (after the serrated jaws have been securely tightened) to break through paint, rust, galvanized coating, or corrosion on the surface that is to be clamped.

A typical grounding cable for transmission line work used by line crews consists of a 2/0 AWG copper cable with an insulating jacket, terminated with an all-angle, self-cleaning aluminum

conductor clamp at one end, and a flat-faced clamp with a set screw at the other end for connecting to a tower leg or ground wire/rod.

8.5.3.4.7 Grounding Cluster Bars

When climbing wood-pole structures, workers may use a grounding cluster bar to connect the phase cables to the pole ground wire, if the ground wire has sufficient capacity to carry the fault current. Cluster bars should have an attached bonding lead. If there is no pole ground wire, the cluster bar for each pole is connected to a common driven or screw-in ground rod with a grounding cable (or cables). In substation grounding, a copper bar is sometimes used to connect the three-phase cables and a fourth cable to a riser from the station ground mat. When installing personal grounds on wood structures from a bucket, the ground cables may be connected between the overhead ground wire (OGW), and the phases without the use of cluster bars provided that an electrical bond of sufficient current carrying capacity exists between the OGW and the structure ground.

8.5.3.4.8 Temporary Ground Rods

Some typical examples of temporary ground rods used for grounding ungrounded structures or mobile equipment, or during conductor splicing operations, are either:

1. A minimum $\frac{5}{8}$ -inch diameter bronze, copper, or copper-weld rod at least 6 feet long, driven to a depth of at least 5 feet; or
2. A 6-foot, screw-type ground rod, consisting of a minimum $\frac{5}{8}$ -inch diameter copper-weld shaft with a bronze auger bit and bronze T-handle, screwed to a depth of at least 5 feet (preferred). The T-handle should be tightly connected to the rod.

If a temporary rod cannot be driven or screwed to a depth of 5 feet, additional rod(s) should be driven or screwed so that a total of at least 5 feet of rod is buried. These rods should be bonded together with grounding cables prior to installing phase grounds. The rods should be placed 6 to 8 feet apart. However, the 10-foot clearance from the rods should be maintained. OGWs may be used at any time to bond the conductors, provided these wires are electrically bonded to the structure ground, either permanently or by personal grounds.

Groundsmen should stay clear (at least 10 feet where feasible) of items such as down guys, ground rods, maintenance vehicles, and structure legs, or ground wires while they are bonded to protective grounds which are in place. When it is absolutely necessary to work on or near these features, employees should use bonded conductive or insulated platforms, or approved insulated shoes, insulated gloves, and leather protectors to minimize the hazard from step and touch potentials.

8.5.4 Testing Before Installing Grounds

Before grounds are installed, the de-energized line or equipment shall^{8.33} be tested for absence of nominal voltage. Appropriate testers for the nominal voltage involved (audio or visual) should be used. They shall^{8.34} be tested immediately before and after use to verify they are in good working condition.

8.5.5 Attaching and Removing Grounds

Employees attaching and removing grounds should comply with the following:

1. Grounding equipment should be visually inspected and all mechanical connections checked for tightness before each use.

2. The surface to which the ground is to be attached should be clean before the grounding clamp is installed or a self-cleaning clamp should be used.
3. No ground should be removed until all personnel are clear of the temporary grounded lines or equipment. When the grounding set is removed, it shall^{8.35} be disconnected from the line or equipment end first with an approved hot-line tool and moved to a point clear of energized conductors before the ground end is disconnected.

8.5.6 Grounding Methods and Location of Grounds in Order of Preference

Employees installing grounds should install them using the information given in the following sections.

8.5.6.1 Work Location

Grounds should be installed at the work location with all grounded parts of different potential bonded together (on wood poles, all down guys, overhead ground wire, neutral conductor, and pole ground). The cluster bar assembly should be installed below the working area and jumper to the ground point, or the neutral conductor and the phase conductor. This is a method of grounding termed "equipotential" grounding. It provides the greatest margin of safety for the line worker by placing everything at equal potential, eliminating the possibility of the line worker getting in series to ground.

8.5.6.2 Multiple Work Locations and Single-Phase Grounding at Work Location

If work is to be performed at more than one place in a line section, the line section shall^{8.36} be grounded at one location and the conductor be grounded at each work location to reduce the potential voltage difference across the work site.

8.5.6.3 Other Locations

Grounds should be placed at the work location or at each side of the work location and as close as practical to it.

8.5.7 Testing Without Grounds

Grounds may be temporarily removed when necessary for testing. Each employee shall^{8.37} use insulating equipment and be isolated from any hazard involved. Additional measures may be necessary to protect each exposed employee in case previously grounded lines or equipment become energized.

8.5.8 Ground Personnel

In cases in which ground rods or pole grounds are used for personal protective grounding, personnel working on the ground should either maintain a safe distance from such equipment or use the appropriate equipment designed to prevent touch-and-step potential hazards. The term "touch potential hazard" refers to the difference in voltage measured between the grounding equipment and a worker in contact with the grounding equipment at the time it is accidentally energized. The term "step potential hazard" refers to the difference in voltage measured between each foot of the worker standing or walking in an electrical field created by high voltage brought to earth.

8.6 INSTALLING OR REMOVING CONDUCTORS

Employees installing or removing conductors should follow certain guidelines to ensure safety.

8.6.1 Working on Energized Line or Equipment

Employees working on energized lines or equipment should comply with the following:

1. Work on electrical equipment and circuits other than electrical utility lines and equipment, operating at 50 V or more ground, should be performed following the guidelines of Section 2.0 of this Handbook.
2. Line or equipment carrying an AC voltage in excess of 600 V phase-to-phase shall^{8.38} be worked on with rubber gloves or live line tools. All other necessary protective devices, such as line hose, hoods, covers, sleeves, and rubber blankets shall^{8.38} be used (see Section 2.1.2).
3. Energized lines shall^{8.39} be worked on from below, whenever possible. When working on energized lines or equipment carrying 600 V or more to ground, there shall^{8.40} be two qualified workers performing the work. Work should not be performed on energized lines or equipment during rain, snow, sleet, fog, and other damp conditions, except in extreme emergencies if, in the opinion of supervision and line crew, it can be done safely.
4. While working on the same pole, workers shall^{8.41} not work simultaneously on wires that have a difference of potential.
5. Rubber gloves of appropriate voltage rating shall^{8.41} be worn when working within reach of a fellow employee who is working on, or within reach of, wires or equipment carrying voltage in excess of 600 V.
6. Insulated hot sticks should be used to open or close load break elbows or fuses or to disconnect blades.

8.6.2 Stringing or Removing De-energized Conductors

Employees stringing or removing de-energized conductors shall^{8.42} follow certain safe work practices. Consideration should be given to the following:

1. When it is necessary to conduct any work on poles or structures carrying more than one circuit and where there is not safe working clearance between circuits, the conductors not being worked on should be:
 - a. Untied and separated with proper clearance from the pole or structure;
 - b. De-energized and grounded; or
 - c. Covered with the necessary protective devices.
2. Prior to stringing operations, a job briefing shall^{8.43} be held setting forth the plan of operation and specifying the type of equipment to be used, grounding devices to be used and instructions to be followed, crossover methods to be employed, and clearance authorization required.
3. When there is a possibility that the conductor might accidentally contact an energized circuit or receive a dangerous induced voltage buildup, in order to protect the employee from the hazards, the conductor being installed or removed shall^{8.44} be grounded or provisions should be made to insulate or isolate the employee.

4. If the existing line is de-energized, proper clearance authorization shall^{8.45} be secured and the line grounded on both sides of the crossover, or the line being strung or removed shall^{8.45} be considered and worked on as energized.
5. When workers cross over energized conductors, rope nets or guard structures shall^{8.46} be installed unless provisions are made to isolate or insulate the workers or the energized conductor. When practical, the automatic reclosing feature of the circuit-interrupting device shall^{8.46} be made inoperative. In addition, the line being strung shall^{8.46} be grounded on either side of the crossover, or considered and worked on as energized.
6. Conductors being strung or removed shall^{8.47} be kept under positive control by the use of adequate tension reels, guard structures, tie lines, or other means to prevent accidental contact with energized circuits.
7. Guard structure members shall^{8.48} be sound, of adequate dimension and strength, and adequately supported.
8. Catch-off anchors, rigging, and hoists shall^{8.49} be of ample capacity to prevent loss of lines.
9. The manufacturer's load rating shall^{8.50} not be exceeded for stringing lines, pulling lines, sock connections, and all load-bearing hardware and accessories.
10. Pulling lines and accessories shall^{8.51} be inspected regularly and replaced, or repaired, when damaged or when their dependability is doubtful.
11. Conductor grips shall^{8.52} not be used on wire rope unless designed for this application.
12. While the conductor or pulling line is being pulled (in motion), workers shall^{8.53} not be permitted directly under overhead operations, nor shall^{8.53} any employee be permitted on the cross arm.
13. A transmission clipping crew shall^{8.54} have a minimum of two structures clipped between the crew and the conductor being sagged. When working on conductors, clipping crews shall^{8.54} install grounds at the work location. The grounds shall^{8.54} remain intact until the conductors are clipped in, except on dead-end structures.
14. Except during emergency restoration activities, work from structures shall^{8.55} be discontinued when adverse weather (such as high wind or ice on structures) makes the work hazardous.
15. Stringing and clipping operations shall^{8.56} be discontinued during an electrical storm in the immediate vicinity.
16. Reel-handling equipment, including pulling and braking machines, shall^{8.57} have ample capacity, operate smoothly, and be leveled and aligned in accordance with the manufacturer's operating instructions.
17. Reliable means of communication between the reel tender and pulling rig operator shall^{8.57} be provided.
18. Each pull shall^{8.57} be snubbed or dead-ended at both ends before subsequent pulls.

8.6.3 Stringing Adjacent to Energized Lines

Employees stringing adjacent to energized lines shall^{8.58} follow certain safe work practices. Consideration should be given to the following:

1. When performing work from structures, clipping crews and all others working on conductors, subconductors, or overhead grounding conductors shall^{8.59} be protected by individual grounds installed at every work location.
2. When workers are stringing adjacent to energized lines, the tension-stringing method or other methods that prevent unintentional contact between the lines being pulled and any worker shall^{8.60} be used.
3. All pulling and tensioning equipment shall^{8.61} be effectively grounded.
4. A ground shall^{8.62} be installed between the tensioning reel setup and the first structure to ground each bare conductor, subconductor, and overhead grounding conductor during stringing across or adjacent to energized lines.
5. During stringing operations, each bare conductor, subconductor, and overhead grounding conductor shall^{8.63} be grounded at the first tower adjacent to both the tensioning and pulling setup and at appropriate intervals. The grounds shall^{8.63} be left in place until conductor installation is completed. Except for moving-type grounds, the grounds shall^{8.63} be placed and removed with a hot stick.
6. Conductors, subconductors, and overhead grounding conductors shall^{8.64} be grounded at all dead-end or catch-off points.
7. A ground should be located at each side and within 10 feet of working areas where conductors, subconductors, or overhead grounding conductors are being spliced at ground level. The two ends to be spliced shall^{8.65} be bonded to each other. It is recommended that splicing be carried out on either an insulated platform or on a conductive metallic grounding mat bonded to both grounds. When a grounding mat is used, it shall^{8.65} be roped off and an insulated walkway provided for access to the mat.

8.7 SPECIAL TOOLS

Line workers should be familiar with special tools that are used for climbing, such as climber gaffs, climber straps, and body belts and should properly store and maintain such equipment. Employees using special tools for climbing and for servicing high-voltage systems should be trained on how to use such tools and equipment. (See Fig. 8-3.)

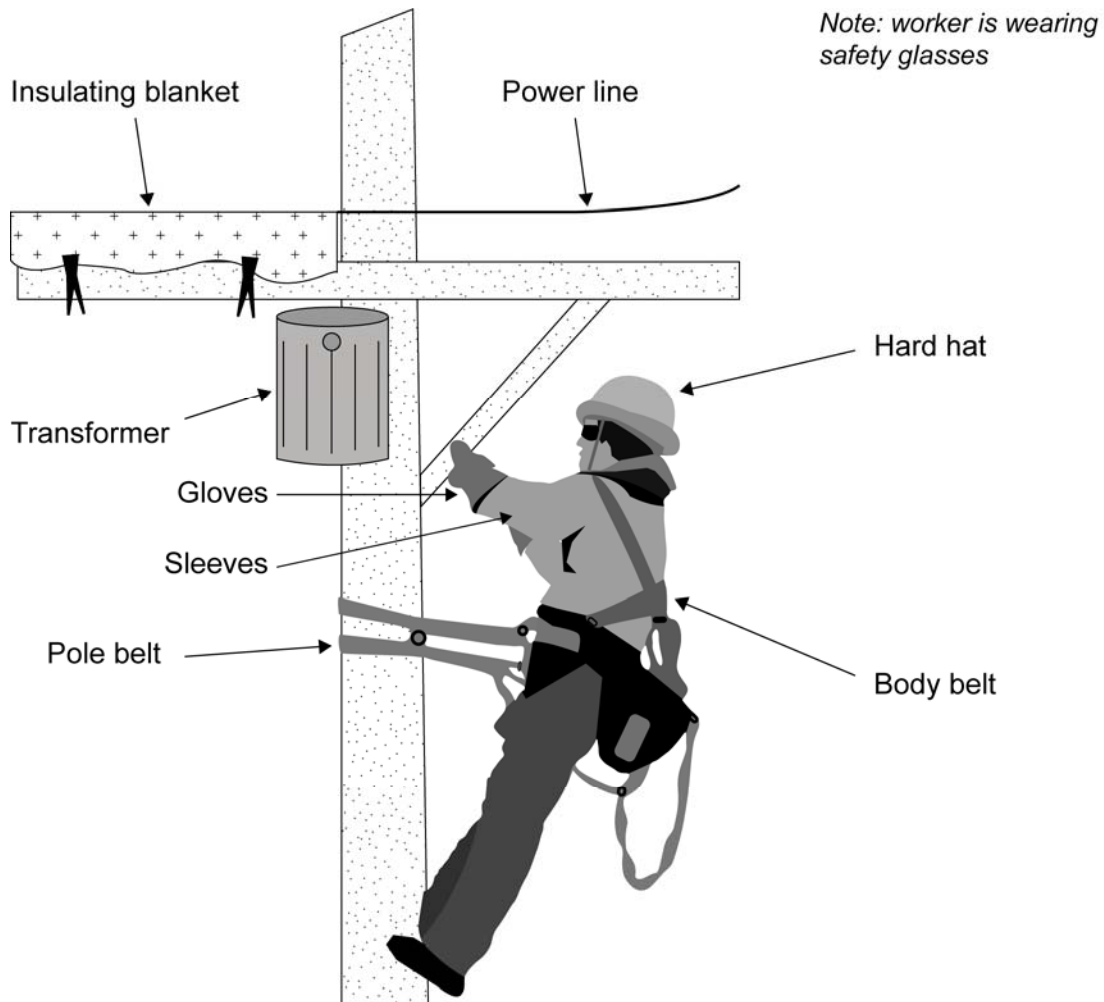

OSHA Sections 29 CFR 1910.132, .133, .135, .136, and .137
OSHA Section 29 CFR 1926.951

Fig. 8-3. Special tools for climbing and servicing high-voltage systems.

8.7.1 Lineworkers' Climbing Tools

Employees should apply the following:

1. All climbers should be inspected before use.
2. Climber gaffs should be kept sharp.
3. A climber should not be used when its gaff becomes shorter than 1¼ inches inside measurement.
4. Climber straps that are worn, or otherwise defective, should be replaced.

8.7.2 Body Belts and Safety Straps

Employees using body belts and safety straps (work positioning equipment) should apply the following:

1. All body belts and safety straps shall^{8.66} be inspected before each use by the employee who uses them.
2. Workers should use their body belts and safety straps when doing any work involving danger of falling.
3. Body belts and safety straps should not be stored with unguarded sharp tools or devices.
4. Heat, sharp bends, and overstressing of body belts and safety straps should be avoided as they are injurious to leather. Wet leather should be dried slowly at moderate temperatures.

8.7.3 Tool Bag and Equipment

Tools, small equipment, and materials should be raised and lowered in a tool bag. The tool bag should be inspected before use to see that it contains no broken glass or other material on which the employee could cut his or her hand or rubber gloves. Tool bags should not have any metal in their construction.

8.7.4 Tapes and Rulers

Workers shall^{8.67} not use metal measuring tapes or tapes having metal strands woven into the fabric, brass bound rules, or metal scales when working near electrical equipment or conductors.

8.7.5 Spoon and Shovels

Tools of this type, especially those having long wooden handles, should not be used when the handles are cracked, split, or broken.

8.7.6 Pike Poles

Pike poles should comply with the following:

1. If cracked, broken, or splintered, pike poles should not be used.
2. Pike poles should not be thrown.
3. When not in use and loaded on the truck, the points should be protected so they do not injure anyone.

8.7.7 Hand Axes and Sharp Tools

Hand axes and sharp tools should comply with the following:

1. Hand axes should not be used on overhead work.
2. When not in use, sharp tools should be protected by the suitable guards or containers.

8.7.8 Handlines and Taglines

The following should be applied for handlines and taglines:

1. High quality, non-conductive handlines and taglines shall^{8.68} be used.

2. Handlines and taglines should be stored in a clean, dry location and protected from damage and contamination.
3. Clean gloves should be worn when handling handlines and taglines to avoid contaminating the rope.
4. Wet, dirty, or damaged lines should be removed from service.

8.8 TREE TRIMMING

Equipment used to trim trees should be maintained in approved and proper working condition to aid tree trimmers and protect them from hazards.

8.8.1 Care and Use of Tools

Tools should be cared for using the following methods:

1. The handles of all tree-trimming tools should be kept well-dressed and varnished.
2. When trimming trees near live conductors, the employee shall^{8.69} not work with wet tools or ropes. Such equipment should be protected during rain showers.
3. A tree-trimming saw should be protected by being put into its scabbard when it is not in use.
4. All ropes shall^{8.70} be inspected frequently for cuts and wear.

8.8.2 Climbing

The following should be applied for climbing:

1. An employee should use a ladder to climb a tree, unless the employee is properly-equipped and trained for tree climbing.
2. Climber gaffs and straps should be designed for tree climbing. The safety strap should be constructed to withstand contact with saws and other sharp objects. Workers in trees should be tied off.

8.9 UNDERGROUND

Underground work requires a means of safe entrance and exit from the workspace. Employees should follow the guidance given in the following subsections to ensure safety in entering and leaving such work spaces.

8.9.1 Working in Manholes, Utility Tunnels, and Vaults

Manholes, utility tunnels, and vaults may be considered confined spaces and if considered a permitted confined space, they shall^{8.71} comply with 29 CFR 1910.146, and these spaces shall^{8.71} comply with 29 CFR 1910.269(e) and (t), and 29 CFR 1926.956. The following may apply to employees working in manholes, utility tunnels, and vaults:

1. Employees who enter manholes shall^{8.72} be trained in the hazards of the confined spaces, confined space entry procedures, and confined space emergency and rescue procedures.
2. When opening a manhole, employees should completely remove the manhole cover from the opening. Manhole covers should be removed before the cable is rodded or installed and removed.

3. Open manholes shall^{8.73} be barricaded and protected by flags or guards as required. All open manholes shall^{8.73} be protected as required by 29 CFR 1910.269(e).
4. Before the pit is entered, it shall^{8.74} be tested for oxygen content and the flammable-gas explosive limit. Workers shall^{8.75} not smoke or use an open flame while tests for an explosive mixture of gas are being made.
5. If the oxygen level is less than 19.5% or greater than 21%, the pit shall^{8.76} be ventilated and retested before any work begins.
6. If the flammable-gas content is more than 10% of the lower explosive limit, the pit shall^{8.76} be ventilated and retested before any work begins. When testing indicates that a manhole contains either a mixture of explosive gas and air richer than safe working limits or flammable liquids, corrective measures shall^{8.77} be taken before work in the manhole is allowed to proceed.
7. When nitrogen is used in manholes or confined areas, approved atmosphere testing devices shall^{8.76} be placed in operation where they can be observed by people in the manhole. When the testing devices show a deficiency of oxygen, all personnel shall^{8.76} leave the manhole until the proper atmosphere is restored.
8. If continuous forced air ventilation is used, it shall^{8.78} begin before entry is made and shall be maintained long enough to ensure that a safe atmosphere exists before employees are allowed to enter the work area. The forced air ventilation shall be so directed as to ventilate the immediate area where employees are present within the enclosed space and shall continue until all employees leave the enclosed space.
9. An attendant is required^{8.79} topside with the means to summon help without leaving his or her station. The attendant shall^{8.80} be capable of instituting a rescue without entering the manhole. The attendant on the surface is responsible for the safety of the persons in the manhole.
10. The topside attendant can perform other duties outside of the enclosed space if these duties do not distract the attendant from monitoring employees within the space. All manholes over 4 feet deep shall^{8.81} be entered with the use of a ladder or climbing device as required by 29 CFR 1910.269 (t)(1).
11. Workers should open all entrance bars or chains on the topside of manhole guards before entering or leaving a manhole. All chains or bars should be closed at all other times, except when raising or lowering tools or materials.
12. Operations involving chemical cleaning agents, solvents, volatile chemicals, cutting and welding equipment, and other hazardous agents or tools warrant additional consideration. Consultation with and concurrence of appropriate industrial safety and industrial hygiene personnel is needed.
13. The employee shall^{8.81} enter or leave a manhole by means of a ladder or climbing device. The employee shall^{8.81} not use a cable, cable hanger, or manhole rack as a support for climbing. A manhole ladder should never be removed while a worker is in the manhole unless absolutely necessary. In the instance of a ladder being removed to make it easier to rescue a worker, the topside attendant should fully devote his or her attention and efforts to instituting a rescue using the worker's body harness and lifeline if necessary. The ladder should be replaced as soon as practical.

Note: The other workers in the hole should be warned that the ladder is to be removed in time to allow him or her to exit the hole, if necessary.

14. Materials, tools, and equipment should be kept at a sufficient distance from the entrance to the manhole to avoid any hazard to the occupant from falling objects, from hot metal, or spilled compounds.
15. Rags, tape, refuse, and combustible and flammable materials should not be allowed to accumulate in a manhole.
16. Instrumentation used to monitor atmospheres in enclosed spaces shall^{8.82} be calibrated per manufacturer's instructions. A record of calibration should be maintained.
17. GFCIs shall^{8.83} be used for 120-V AC power.
18. All cables and insulated wires that do not have grounded conducting sheaths or shielding should be treated as bare conductors. Cables and insulated wires shall^{8.84} be considered energized, unless approved methods have been used to determine that they are de-energized. If these conductors are within reach of a worker, they shall^{8.84} be barricaded or covered with protective equipment or devices. Before entering a manhole containing cables or wires that do not have grounded conducting sheaths, a risk assessment should be performed that considers the age and condition of the insulation. If determined necessary, appropriate PPE should be used by workers where shock hazards or arc flash hazards exist.
19. Where multiple cables are present, the cable to be worked on shall^{8.85} be identified by electrical means, unless its identity is obvious. When cables have one or more abnormalities that could be an indication of an impending fault, the defective cable shall^{8.86} be de-energized, except when service load conditions and a lack of feasible alternatives dictate that the cable remains energized. In that case, employees may enter the manhole, if they are protected from the effects of the failure by flash blankets or other devices capable of containing the adverse effects of the fault.

8.9.2 Working on Energized Underground Cables

In general, work should not be performed on energized underground cables. However, strictly external work, not requiring an appreciable change in location of the cable, may be performed under direct supervision. Energized cables that are to be moved shall^{8.87} be inspected for defects.

8.9.3 Terminals of Underground Cables (Potheads)

Before work is started, the overhead line connections to a cable terminal upon which work is to be performed should be either:

1. De-energized and grounded; or
2. Disconnected and covered with protective equipment.

8.10 FERRO-RESONANCE

Ferro-resonance can generate overvoltages of up to 12 times line-to-ground source voltage upon opening of a single-phase device or a poorly synchronized three-phase device. Violent failure can occur, exposing personnel to the high-voltage failure and accompanying conditions. Ferro-resonant conditions can result in damage to lightning arresters, switching devices, buried cable, transformers, and associated equipment.

Ferro-resonance can be initiated when all of the following elements are present and the switching means at dip point or takeoff is either a single-phase device or an unsynchronized three-phase device that does not operate all phases within one-half cycle:

1. System grounded at the source, but with no ground at the transformer bank, such as a transformer or transformer bank connected delta on a grounded-wye system;
2. Shielded cable or overhead conductor length sufficient to create the capacitance necessary;
3. Transformer size that permits saturation of the iron core at the operating voltage; and
4. Transformer unloaded or very lightly loaded.

Prevention or control of ferro-resonance may be accomplished by any of the following measures:

1. Using a wye-wye transformer connection with both neutrals grounded and tied to the system neutral;
2. Using only phase-to-neutral (not phase-to-phase) transformer connections for single-phase transformers;
3. Limiting the length of underground cable between transformers and single-pole or poorly synchronized three-pole switching devices;
4. If single-pole or poorly synchronized switching devices are used, ensuring that transformer and underground cable are loaded in excess of 2% resistive load of the transformer capacity;
5. If the transformer primary is ungrounded-wye, temporarily grounding the neutrals of the transformers being switched; or
6. Installing close-coupled, high-speed, three-pole switching devices to minimize the duration of the single-phase condition during opening and closing of the circuit.

9.0 TEMPORARY WIRING

It is necessary that temporary wiring comply with all the requirements pertaining to permanent wiring unless specific exceptions are stated, which can be found in OSHA regulations and NEC Article 590.

9.1 REQUIREMENTS AND INSTALLATION CONDITIONS OF USE

Temporary electrical installations shall^{9.1} be allowed during periods of construction, remodeling, maintenance, repair, or demolition of equipment or structures or for experiments and developmental work. However, such temporary installations are not substitutes for permanent installations and shall^{9.2} be removed as soon as the construction, remodeling, experiment, or other special need is completed.

9.1.1 Contact Prevention

Except as modified in NEC, Article 590, temporary wiring shall^{9.3} meet all the requirements of the NEC for permanent wiring to prevent accidental contact by workers or equipment.

9.1.2 Vertical Clearances

Vertical clearance of wires, conductors, and cables above ground shall^{9.4} meet the requirements of the NEC Article 230 for services or Article 225 for feeders.

9.1.3 Wet Locations

Conductors with non-rated, weather-proof insulation shall^{9.5} not be enclosed in metal raceways or used for wiring in tanks, penstocks, or tunnels. Receptacles used in damp or wet locations shall^{9.6} be approved for that purpose. When a receptacle is installed outdoors (outdoors is considered a wet location), it shall^{9.6} be contained in a weatherproof enclosure, the integrity of which would not be affected when an attachment plug is inserted.

All temporary lighting strings in outdoor or wet locations, such as tunnels, culverts, valve pits, outlets, and floating plants, shall^{9.7} consist of lamp sockets and connection plugs permanently molded to the hard service cord insulation.

In job locations where employees are likely to contact water or conductive liquids, GFCI protection for personnel using portable electrical tools shall^{9.8} be used.

9.1.4 Bushings

Flexible cords and cables shall^{9.9} have bushings at all outlets and terminals to prevent abrasion and damage to the insulation.

9.1.5 Lighting

All lamps for general illumination should be protected from accidental contact or breakage. Metal-case sockets shall^{9.10} be grounded.

Temporary lights shall^{9.11} not be suspended by their electric cords, unless cords and lights are designed for this means of suspension. Temporary lighting used in damp, wet, or hazardous areas shall^{9.7} be marked as suitable for use in those locations.

Portable electric lighting used in wet or other conductive locations (for example, drums, tanks, and vessels) shall^{9.12} be operated at 12 V or less. However, 120-V lights may be used if protected by a GFCI.

Receptacles on construction sites shall^{9.13} not be installed on branch circuits that supply temporary lighting.

9.1.6 Confined Spaces

Confined space entry shall^{9.14} be in accordance with OSHA 29 CFR 1910.146 requirements.

When temporary wiring is used in tanks or other confined spaces, an approved disconnecting means (identified and marked) should be provided at or near the entrance to such spaces for cutting off the power supply in emergencies.

Portable electric lighting used in confined wet or hazardous locations, such as drums, tanks, vessels, and grease pits shall^{9.12} be operated at a maximum of 12 V, be intrinsically safe, or be protected by a GFCI circuit.

9.1.7 Exposed Sockets and Broken Bulbs

Exposed empty light sockets and broken bulbs shall^{9.15} not be permitted. This rule is to protect personnel from accidentally contacting the live parts in the socket and being shocked.

9.1.8 Ground Fault Protection for Personnel

Temporary power to equipment used by personnel shall^{9.16} be protected by GFCI devices, where required, or included in an assured EGC program, where permissible. See NEC 590 for further information.

9.1.9 Wiring Methods

The requirements for temporary wiring for power and lighting purposes include provisions for wire connections, junction boxes, and overcurrent protection, as well as the use of conductors. (See NEC 590 for further information.)

9.1.9.1 Service Conductors

Service conductors shall^{9.17} comply with all the provisions of NEC, Article 230 when they are used as wiring methods to supply temporary power systems.

9.1.9.2 Feeder Conductors

Feeders are the conductors that transmit power from the service equipment to the distribution panelboard or between the main disconnect and the branch circuit overcurrent devices (circuit breakers, fuses). Feeders for temporary wiring shall^{9.18} originate inside an approved distribution center, such as a panel board, that is rated for the voltages and currents the system is expected to carry. Some equipment is manufactured specifically for temporary use.

Feeders can be run as cable assemblies, multiconductor cords, or cables with two or more conductors each with their own insulations, run together in the same cord or cable.

9.1.9.3 Branch Circuit Conductors

Branch circuits are the conductors between the last overcurrent device in an electrical system and the outlets, such as receptacles, lighting outlets, and outlets for electrical equipment wired directly into a circuit. Branch circuits for temporary wiring shall^{9.19} originate inside an approved panelboard or power outlet that is rated for the voltages and currents the system is expected to carry. As with feeders, branch circuit conductors may be contained within multiconductor cord or cable assemblies.

9.2 Using Assured Equipment Grounding Conductor Program

If GFCI devices are not used (see Section 4.7), the employer shall^{9.20} establish and implement an assured EGC program at construction sites covering all cord sets, receptacles that are not a part of the building or structure, and equipment connected by cord and plug that are available for use or used by employees (see Fig. 9-1). This program shall^{9.20} comply with the following minimum requirements:

1. A written description of the program, including the specific procedures adopted by the employer, shall^{9.20} be available at the job site for inspection.
2. The employer shall^{9.20} designate one or more competent persons to implement the program.
3. Each cord set, attachment cap, plug and receptacle of cord sets, and any equipment connected by a cord and plug, except cord sets and receptacles that are fixed and not exposed to damage, shall^{9.20} be visually inspected before each day's use for external defects such as deformed or missing pins or insulation damage and for indications of possible internal damage. Equipment found damaged or defective shall^{9.20} not be used until repaired.
4. The following tests shall^{9.20} be performed on all cord sets, receptacles that are not a part of the permanent wiring of the building or structure, and cord-and-plug connected equipment required to be grounded:
 - a. All EGCs shall^{9.20} be tested for continuity and shall^{9.20} be electrically continuous.
 - b. Each receptacle and attachment plug shall^{9.20} be tested for correct attachment of the EGC. The EGC shall^{9.20} be connected to its proper terminal.
5. All required tests shall^{9.20} be performed:
 - a. Before first use;
 - b. Before equipment is returned to service following any repairs;
 - c. Where there is evidence of damage; and
 - d. At intervals not to exceed three months, except for cord sets and receptacles that are fixed and not exposed to damage shall^{9.20} be tested at intervals not exceeding six months.
6. The employer shall^{9.20} not make available, or permit the use by employees of, any equipment that has not met the requirements of this section.
7. Tests performed as required in this section shall^{9.20} be recorded. This test shall^{9.20} identify each receptacle, cord set, and cord-and-plug-connected equipment that passed the test and shall^{9.20} indicate the last date it was tested or the interval for which it was tested. This record shall^{9.20} be kept by means of logs, color coding, or other

effective means and shall^{9.20} be maintained until replaced by a more current record. The record shall^{9.20} be made available on the job site.

Electric hand tools should be checked when first placed on the job and repaired if damaged.

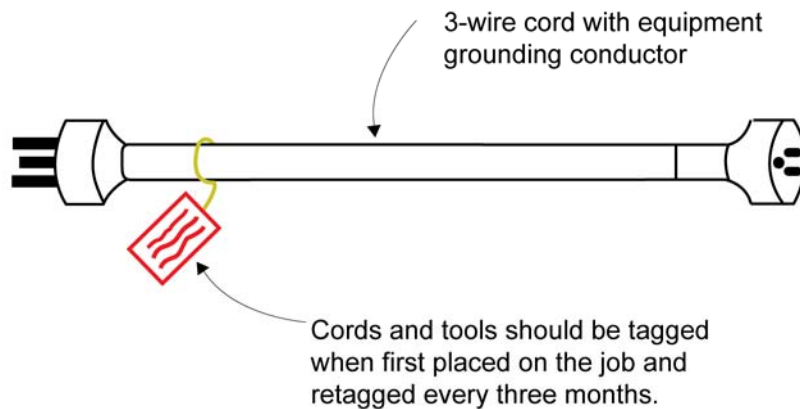
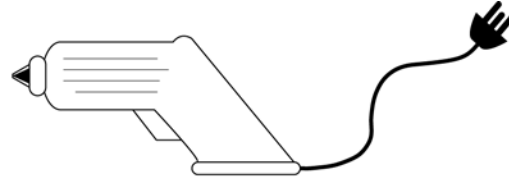

OSHA Section 29 CFR 1926.404(b)

Fig. 9-1. Grounding Conductor Program Equipment.

9.3 PORTABLE ELECTRICAL TOOLS AND EQUIPMENT

The program should include the essential ingredients of Chapter 19 of NFPA 70B, *Portable Electrical Tools and Equipment*, and ANSI/UL 745 Series, *UL Standard for Safety for Portable Electric Tools*. This includes employee training, maintenance, cord and attachment plug care, extension cords, major overhauls, and leakage current testing.

9.3.1 Inspection and Maintenance

Portable electric tools and equipment such as cords, plugs, and GFCIs should be inspected before use by both the issuer and the user for: signs of chaffing, cracking, wear, or other forms of faulty insulation; evidence of a faulty grounding conductor, cracked plug, or receptacle housing; bent or missing plug or connector prongs; dead front plugs, receptacle, or connectors; a missing, bent, or otherwise abused switch; or, an improperly functioning trigger lock (dead-man's switch). While in use, tools and equipment should be observed for proper operation, including any signs of overheating or excessive sparking. Portable electric tools, equipment, and GFCIs should be inspected or trip-tested by the user each day before use. Signs of a defect shall^{9.21} require the return of the device for repair.

9.3.2 Conditions of Use

Portable electric tools, equipment, and GFCIs shall^{9.22} not be used in hazardous locations, unless marked to indicate suitability for such use.

Portable electric tools and equipment shall^{9.22} not be handled or suspended by their cords. Tools and equipment shall^{9.22} be used only for their intended purpose, and when guards are required, such guards shall^{9.22} be in place and functional.

Tools and equipment shall^{9.22} be grounded via the case, double-insulated, specially approved low voltage types, or self-contained and battery-operated.

Tools and equipment used in damp areas should be approved for such use. Generally, electrical tools are not approved for use in wet or damp areas without other means of protection.

9.3.3 Use of Extension Cords

Use of extension cords should be minimized. Such cords shall^{9.23} be selected, based on intended use, such as length, gauge of conductors, waterproof connectors for wet or damp areas, and are subject to the same conditions as the tool or equipment cord. Extension cord sets shall^{9.23} be listed as an assembly by an NRTL (see Section 2.5). Extension cord sets used on construction sites shall^{9.23} contain the number of conductors necessary for the circuit, plus an EGC. The cords shall^{9.23} be hard use or extra-hard use as specified in the NEC. Daisy chaining of extension cord sets is prohibited by the listing requirements.

Extension cords shall^{9.23} be visually inspected before each use and, if damaged or worn, they shall^{9.23} be replaced.

Extension cord sets used at construction sites and used with portable metal electric tools and appliances shall^{9.24} be of three-wire type and shall^{9.24} be designed for hard or extra-hard usage. Flexible cords used with temporary and portable lights shall^{9.24} be designed for hard or extra-hard use. Extension cords approved for outdoor use may be identified by "outdoor" or "W-A" on the jacket.

9.3.4 Double Insulated Tools

The NEC references the use of double-insulated tools in UL Standard UL 1097, *Double Insulation Systems for Use in Electrical Equipment*, which provides the requirements for equipment marked "Double Insulation" or "Double Insulated." Since the end product standard takes precedence, the end-product UL Standard should also be consulted when there are questions pertaining to products that require double insulation.

Double insulation is a system comprised of two insulation systems (basic and supplementary) that are physically separated and are not subjected to temperature, contaminants and other deteriorating factors at the same time.

Basic insulation is applied to live parts to provide protection against electrical shock. Supplementary insulation is independent of the basic insulation and provides protection against electrical shock in case of failure of the basic insulation. Also of importance is the reinforced insulation that consists of one or more layers of insulating material that, in itself, provides the same degree of protection as double insulation.

For example, two layers of insulation separating an armature lamination from an armature conductor is not double insulation. This is reinforced insulation. To achieve a double insulated system, one layer of insulation separates the armature lamination from the armature conductor (basic insulation) and an insulating sleeve provides a second layer between the armature lamination and the motor shaft (supplementary insulation).

Generally, double insulated equipment is constructed such that double insulation is provided between all live parts and (1) the accessible surfaces of the equipment, and (2) all inaccessible parts and surfaces that are conductively connected to the accessible surfaces of the equipment.

Under certain conditions, reinforced insulation systems are acceptable when applied to brushcaps; brushholders; commutators, and end turns of armature winding switches; power supply cords; and, internal wiring.

Power supply cords for double-insulated tools shall^{9.25} be jacketed and shall^{9.25} not include a grounding conductor.

"Double insulated" or "double insulation" (UL 1097) are permanently marked on the tool. In addition, the double insulated symbol (a square within a square) may be used.

10.0 ELECTRICAL SAFETY DURING EXCAVATION

10.1 GENERAL

Unexpected contact with underground or embedded utilities during excavations, concrete drilling and earth moving operations can occur at DOE facilities and throughout private industry.

Inadvertent striking of underground utilities can and does result in electrical shock, injuries, explosions, utility outages, operational interruptions, and death. These pipes, wires or conduits are frequently missing from as-built or other record drawings.

Large-scale decontamination and decommissioning, environmental restoration, and new construction projects performed at DOE facilities bring with them a significant risk of contact with underground or embedded utilities. Therefore, it is essential that effective policies and procedures be implemented to control and minimize this risk.

10.2 UTILITIES IDENTIFICATION

Before locating underground or embedded utilities, facility personnel should obtain and review available information for the location area. Resources might include available drawings, sketches, and site knowledge. Failing to thoroughly research and review all available information, from the original installation up to the present layout, before beginning an underground or embedded utility detection survey can lead to possible hazards and problems for locators. Facilities often utilize direct burial trenches to stack utilities and locator equipment often identifies only the utility closest to the surface.

Facility drawings and/or configuration control methods often separate utilities by function, making this initial research very important.

Relying on current locating technology alone has resulted in many encounters with buried and embedded utilities.

10.2.1 Configuration Management

The following are elements of a configuration management program:

1. Facility controlled drawings identifying utilities locations.
 - a. Voltage levels, burial depth, and elevation details for "stacked" utilities are useful information to include on drawings.
2. As-built drawings/sketches that are often required to be submitted for all new utilities installations.
3. Survey point locations that are required at some DOE facilities.
 - a. This provides very accurate locations for future reference.
 - b. Some DOE facilities utilize Global Positioning Satellite equipment to mark utility locations.

10.2.2 Excavation Permit

The excavation permit ensures the scope of the excavation is clearly defined. It also ensures the area to be excavated is reviewed by the appropriate facility personnel, prior to beginning the work. The use of this permit is recommended for operating facilities and older facilities which do not have exceptional configuration management. If it is a requirement, the permit also ensures that consistent work authorization is maintained.

A typical excavation permit contains the following, as a minimum:

1. Detailed scope of work to be performed;
2. Accurate definition of boundaries for the proposed excavation;
3. Signoffs for appropriate subject matter expert reviews, if required;
4. Accurate excavation maps, with all known utilities identified and boundaries clearly marked; and
5. Work authorization signoff.

10.3 UTILITIES VERIFICATION AND MARKING

Effective methods used for a utilities verification and marking include:

1. Field walk-downs of excavation site by approved subject matter experts.
2. Testing to validate identified utilities.
3. Testing to identify utilities, not yet identified:
 - a. Ground penetrating radar method.
 - b. Passive/active frequency method.
4. Survey Paint Markings and/or Survey Flags:
 - a. should be durable and timed to effectively coincide with the work group mobilization;
 - b. should be installed no more than two or three days prior to the actual excavation work; and
 - c. should be verified immediately prior to the beginning of the excavation work.
5. Utilities color coding:
 - a. Same American Public Works Association (APWA) color coding as municipalities use.

10.3.1 Field Location of Excavation Boundaries

Accurate identification of excavation boundaries is necessary. It accurately communicates those boundaries to all workers and supervisors. It also sets the excavation limits, based on the research and locator testing provided for that particular excavation. Elements of the identification of locations and excavation boundaries include:

1. Excavation maps that can be used to identify exact excavation boundaries (field markings can easily be transferred from these maps);

2. Excavation maps that can be attached to the excavation permits for additional communication assurance; and
3. Appropriately marked field excavation boundaries.

10.3.2 Locator Equipment Selection and Limitations

It is important to note that no locator technology should be relied upon as the sole source for identifying buried or embedded utilities. Configuration management is the most effective identification method.

The majority of underground utility locators being used today apply a signal to the underground system being located. This signal may either be of an audio or radio frequency. An active signal is applied to the underground utility by various methods, with the signal being generated from the transmitter unit of the location system. Proper setup of the transmitter increases the accuracy of the receiver unit. Proper use of the receiver unit dictates that the antennas be moved in a straight path and not in a swinging motion. Accurate depth readings are gained from experience.

Electromagnetic (EM) pipe and cable locators feature microprocessor-controlled transmitters and receivers capable of detecting power lines, telephone cables, and metal piping at depths up to 20 feet. These detection devices operate with multiple discrete broadband frequencies, antenna configurations, and grounding capabilities.

10.3.2.1 Direct or Conductive Method

One method of applying a signal to a known utility is the inductive clamp or coupler, where the signal is induced to the utility by means of a jawed clamp placed around the utility access point without the grounding system being disturbed. Inductive couplers and clamps all apply a signal to the utility in basically the same manner. The signal is induced onto the utility to be located by an electromagnetic field created by the coupler and clamp. It is necessary that the utility have grounds in place at both ends of the section to be located. Missing bonds across insulated sections of the utility prevents this method from being used along the entire length of the utility. Underground metal pipes and cables should not be joined with conductive materials, thus making them short, separated pieces of a broadcast antenna. There could be multiple utilities bonded together (i.e., cathodic protection and common grounding), making their individual resolution difficult. These and other problems create the need for variety within the EM method itself. Couplers and clamps should be positioned below the electrical grounding point on CATV, electrical, and telephone cables. Systems that do not use earth ground, such as railway signal cables, cannot be located with couplers or clamps. Gas meters with insulated couplings should not be bonded. They should be direct-connected.

10.3.2.2 Inductive or Indirect Method

Another method is the inductive or indirect mode. With this method, the transmitter is placed on the surface of the ground above the known utility. The signal from the transmitter is induced onto the utility, making location of the utility possible. Inductive transmitters should only be used when access points for the utilities are not available. This method can lead to serious tracing errors, especially if other utilities are buried/embedded in the same area.

10.3.2.3 Detector Frequency and Power Considerations

Choosing the appropriate locator technology and methods greatly improves the chances of success. As an operator attempts to detect the location of underground/embedded utilities, the

frequency and power capabilities of the instrument being used should be understood. In many detectors, as the frequency increases, the available power decreases.

Frequency selection can affect depth of penetration, distance of travel, resonance efficiency, and resolution issues, as well as other operating characteristics. Most locator manufacturers preset frequencies, and there is an optimum frequency to use for a particular utility system. These are some of the most frequently used:

1. **ELF (Extremely Low-Frequency)** operates at below 300 Hz. It is typically used for: power cables that are energized and carrying a load; water pipes grounded to a power system that are energized and carrying load; and deep, very conductive, long-length utilities.
2. **VLF (Very Low-Frequency)** operates between 3kHz and 30 kHz. It is typically used for very long, continuous conductors, and deep conductive long length utilities.
3. **LF (Low-Frequency)** operates between 30kHz and 300kHz. It is typically used for shallow (8 feet or less) conductors of medium length.
4. **HF (High-Frequency)** operates between 3MHz and 30MHz. It is typically used for cables; shallow short conductors.

Not all utilities are metallic or of sufficient length in the ground. Therefore, resonant EM methods are not always the answer. The current family of surface geophysical methods available for utility and other near-surface structure or hazard detection is extensive. Other EM techniques such as measuring eddy currents, differential heat, and thermal reflection are also available. Below are three types presently in use:

1. **Terrain Conductivity** uses the VLF range, which uses Eddy Currents to measure differences in ground conductivity. It has proven useful in locating very deep or short metallic utilities and air/gas-filled utilities.
2. **Ground-Penetrating Radar** which uses 1-100 gigahertz microwaves to measure reflections due to dielectric differences in subsurface materials. It measures the strength and amount of time necessary to bounce a signal off different layers. This technology is effective only in resistant soils. Utilities should be of sufficient size to be detected. The deeper the utility, the larger it should be in order to be detected. Highly different soil/utility materials give the best results.
3. **Thermal** measures heat output. When the amount of heat from the utility is different from that of the surrounding soil, it might be detectable. Some utilities produce their own exothermic heat or retain heat longer than the surrounding soil.

10.3.3 Locator Operator Training

Each piece of locating equipment is unique. It is very important that operators be trained to use the equipment before applying it in a field application that determines safe boundaries for excavation workers. Some of the ground penetrating radar equipment is very dependent on operator interpretation of the characterization profiles generated from the locator equipment. Operators unfamiliar with the equipment specifications and operating instructions can make interpretive mistakes that can lead to serious injury to the excavation workers.

Proper selection of available techniques and the use and interpretation of data produced by this equipment is essential to the accurate and comprehensive detection of underground utilities. Regular calibrations and maintenance of locator equipment should be established.

10.3.4 Field Marking of Identified Utilities

Paints/Surface Markings are used at many jobsites. Care should be taken to ensure the markings are clearly present and identifiable at the time the excavation workers arrive at the excavation site. Many cases of faint markings and/or markings washed away by rain have been documented at jobsites. The recent use of biodegradable survey paints has increased this possibility. They are not as durable as former types of survey paints used. Lawn mowing equipment can erase or diminish the effectiveness of survey paints in outside areas.

Stakes or Flags are used to mark identified utilities at some job sites. These should be durable, and able to withstand the environments they are exposed to. Lawn mowing equipment can erase all traces of survey flags in very short order. Incidents resulting from missing and even relocated stakes or flags have been documented.

Utilities Color-Coding is used at most work locations. The standard utilities color-coding is well understood by most excavation subcontractors, and serves as a very effective communications tool for the facility owner.

Plastic Utilities Ribbon Tape is used in most facilities, as well as commercial and industrial applications. It is installed directly above the utility, but below the surface of the ground so an excavator can dig it up, and thereby indicate the presence of a utility, before the utility is damaged.

Metallic Utilities Ribbon Tape is used in many facilities. It is buried at a specified depth above the utility. This ribbon can be detected and its route traced by a metal detector.

10.4 UTILITIES DISPOSITION

Utilities identified during the planning stages should be evaluated to determine their function as it relates to the facility. Every effort should be made to de-energize and lock out power cables that could be encountered by excavations workers. Telecommunications and signal/monitoring circuits should also be considered. Planned outages are the preferred approach. Schedules and/or convenience should not take precedence. The impact to the facility, in the event of damage to these cables/circuits, should be part of the evaluation.

10.5 WORK CONTROL DURING EXCAVATIONS

10.5.1 Safety Equipment and Procedures

The requirements for safety equipment should be understood. In some facilities, concrete wall and slab excavations require both mechanical and electronic drill-stops. Some facilities require insulated footwear and/or gloves for certain types of excavations or certain site areas. These requirements should be effectively communicated to the excavation workers.

10.6 THE EXCAVATION PROCESS

Once the planning is complete, the excavation process is ready to begin. Work control procedures are in place, all hazards have been identified, hazards elimination/mitigation is established and personal protection requirements have been determined and are understood by all involved excavation personnel.

10.6.1 Excavations in Concrete Walls and Slabs

Excavations in concrete walls and slabs should be included in facility procedures. Drilling holes, coring, chipping, or cutting holes in these areas is included. Some DOE facilities require excavation permits be issued for penetrations to a depth of 3 inches, or greater, in concrete walls or slabs. Due to variation in facility design, the allowable depth may vary.

The concern is encountering structural rebar or, worse, energized electrical power cables. DOE sites have recorded many incidents of this type. The opportunity for this type of incident seems to be higher when dealing with older facilities/buildings. Configuration management for these commodities can be just as bad in newer buildings. Embedded commodities are often omitted from as-built drawing requirements. Most installation drawings are diagrammatic, or field-routed. This policy can provide significant problems in the years following installation. A facility that requires accurate as-built drawings of embedded power cable conduits is investing in their electrical safety program.

The use of insulated rubber gloves is recommended for all workers drilling or cutting into concrete walls and slabs, as an additional safety measure.

In addition to other safe work practices when drilling or cutting concrete, consideration should be given to the use of a drill stop. The drill stop prevents accidental cutting of reinforcing bar and conduit by turning off the power to the drilling unit when grounded metal is encountered. By preventing users from drilling into conduit, contact with live electrical circuits is avoided.

The drill stop is intended primarily to sense the presence of grounded metal in concrete and to prevent damage to this metal by terminating power to the drill motor when it is detected. Since this function necessitates electrical isolation of the drill bit, tool casing and tool ground line, additional switching circuitry is needed to provide operator safety in cases where leakage current from the motor may be present or where energized lines may be encountered during the drilling operation. A typical drill stop provides this protection by switching voltage potentials in excess of 10 volts to a low impedance, high current capacity ground path. This switching operation is accomplished in a maximum of 5 microseconds. Voltages of up to 600V and currents of up to 110 Amps RMS continuous (1000 Amps peak on cycle, non-repetitive surge current) are switched to ground. Voltages and currents in excess of these values will also be switched to ground but may result in failure of the switching circuitry in the closed (conducting to ground) condition.

10.6.2 Machine or Hand Digging

Machine digging in earth necessitates careful consideration. The identified depth of utilities is not accurate in many cases. Machine operators, in general, do not appreciate the value of maintaining the integrity of energized power cables. A strong safety program, with specific procedures, can make the difference between a successful excavation and an incident or accident.

Several facilities require identified utilities to be positively located by hand digging to uncover them. This provides additional assurance of their location and depth of burial. Many times, both dimensions are significantly different from those marked by locating equipment. Special tools and personal protective equipment are often used to accomplish this. The "air lance" and "high pressure water lance," combined with high suction vacuum, are examples of these special tools.

10.7 AS-BUILT DRAWINGS

As-built drawings have provided significant improvements in the various excavation activities/programs across the DOE complex. Configuration management of buried or embedded utilities has improved at every facility that implements the as-built drawing requirement. It is a tool that is strongly recommended. As-built drawings should not be relied upon as the only source for the accurate location of underground/embedded utilities.

11.0 ENCLOSED ELECTRICAL/ELECTRONIC EQUIPMENT

This section addresses enclosed electrical/electronic equipment electrical safety guidelines which are not specifically addressed elsewhere in this Handbook. These types of equipment include: instrumentation and test consoles; enclosed electrical/electronic equipment; other laboratory diagnostic electrical/electronic equipment (stationary or mobile) mounted in, or on, an enclosure, rack or chassis; and, special electrical/electronic equipment facility requirements. It provides guidelines to:

1. Complement existing electrical codes and recommend industry standards;
2. Improve electrical safety in the work environment for personnel within the DOE complex;
3. Eliminate the ambiguity and misunderstanding in design, construction and implementation requirements for electrical/electronic equipment;
4. Assist the AHJ in providing information for acceptance of equipment within the scope of this document; and
5. Guide the use of typical vendor supplied equipment cabinet racks (i.e., 19-inch cabinet rack enclosure), and provide guidance for procurement specifications.

11.1 GROUNDING AND BONDING

Many ground system types exist within electrical equipment. All metal parts of electrical equipment enclosures and chassis that are likely to become energized shall^{11.1} be bonded and/or grounded, as per the NEC. The methods chosen to avoid ground loops and reduce noise shall^{11.1} meet the requirements of NEC 250.6 and 250.24(A)(5).

11.1.1 Objectionable Current over Grounding Conductors

Enclosed electrical/electronic equipment may have both power and signal conductors entering and leaving these enclosures. Objectionable currents and noise may be the result of the design or installation of conductors and equipment and their grounding locations. NEC 250.6 addresses these objectionable currents and noise.

NEC 250.6(D) specifically indicates that the introduction of noise or data errors in electronic equipment shall^{11.2} not be considered objectionable currents, as addressed therein. Therefore, such objectionable currents are handled in other ways. NEC Section 250.6 principally deals with objectionable currents that can flow over grounding conductors due to severely unbalanced loads or improper installation practices. NEC 250.96(B) provides requirements for isolation of grounding circuits to reduce electrical noise, known as electromagnetic interference (EMI). Because of the complexity and number of interconnections of most grounding systems, the NEC allows modifications of the grounding system and connections, in order to address such problems. Those permitted modifications are as follows:

1. Arrangement to prevent objectionable current. Grounding of electrical systems, circuit conductors, surge arresters, surge-protective devices, and conductive normally noncurrent-carrying metal parts of equipment shall^{11.3} be installed arranged in a manner that prevents an objectionable current over the grounding conductors or grounding paths. Use of a single-point grounding system, as well as meeting the other requirements of NEC Article 250, usually overcomes problems. (NEC 250.6(A))
2. Alterations to stop objectionable current. If the use of multiple grounding connections results in an objectionable current, one or more of the following alterations are permitted

to be made, provided that the requirements of NEC 250.4(A)(5)(B)(4), are met. Such permitted alterations are:

- a. Discontinue one or more, but not all, of the grounding connections;
 - b. Change the locations of the grounding connections;
 - c. Interrupt the continuity of the conductor or conductive path causing the objectionable current. (NEC 250.6(B)); or
 - d. Take other suitable remedial action satisfactory to the authority having jurisdiction.
3. Temporary currents not classified as objectionable currents. Temporary currents resulting from accidental conditions, such as ground-fault currents, that occur only while the grounding conductors are performing their intended protective functions shall^{11.4} not be classified as objectionable. This does not prohibit changes in the system to correct excessive current during a fault condition.
 4. Limitations to permissible alterations. The intent of NEC 250.6 is not to permit electronic equipment to be operated on AC systems or branch circuits that are not connected to an EGC required by NEC Article 250. Currents that introduce noise or data errors in electronic equipment are not considered to be the objectionable currents addressed in this Section (NEC 250.6(D)).

Voltage differences, and thus, objectionable currents may exist because impedances to ground are not equal throughout a grounding system, due to variations of the resistance of the earth, improper connections, or other problems.

Even though voltage differences allow unwanted currents to flow in the grounding conductors, and induced noise may travel over this path, it is not to be used as a reason to disconnect all grounding connections to any system component. At least one grounding connection shall^{11.1} remain as a path for any type of fault current that may occur.

11.1.2 Enclosure Equipment Grounding and Bonding

Enclosure equipment grounding and bonding shall^{11.5} comply with the following requirements for exposed equipment likely to become energized (see Figs. 11-1 thru 11-3):

1. Have a common equipment grounding or bonding bus (normally a cabinet rail).
2. When the enclosure contains more than one bay, bond all grounding or bonding busses together.
3. Ensure that all mounted chassis within rack cabinets shall^{11.5} have a grounding or bonding conductor. This should be attached to the common grounding or bonding bus when the chassis is not grounded or bonded through the power cord.
4. Ensure that the equipment grounding or bonding conductors shall^{11.5} be continuous and for separable connections, and provide for first make and last break arrangements for the conductor.
5. Ensure that subassemblies mounted in other types of enclosures shall^{11.5} be bonded by adequate preparation of the mounting surfaces or by the use of a bonding conductor.
6. Provide protection against equipment grounding or bonding conductor breakage, and ensure that conductors between the common equipment grounding or bonding bus and that moveable chassis are braided cable or stranded wire.

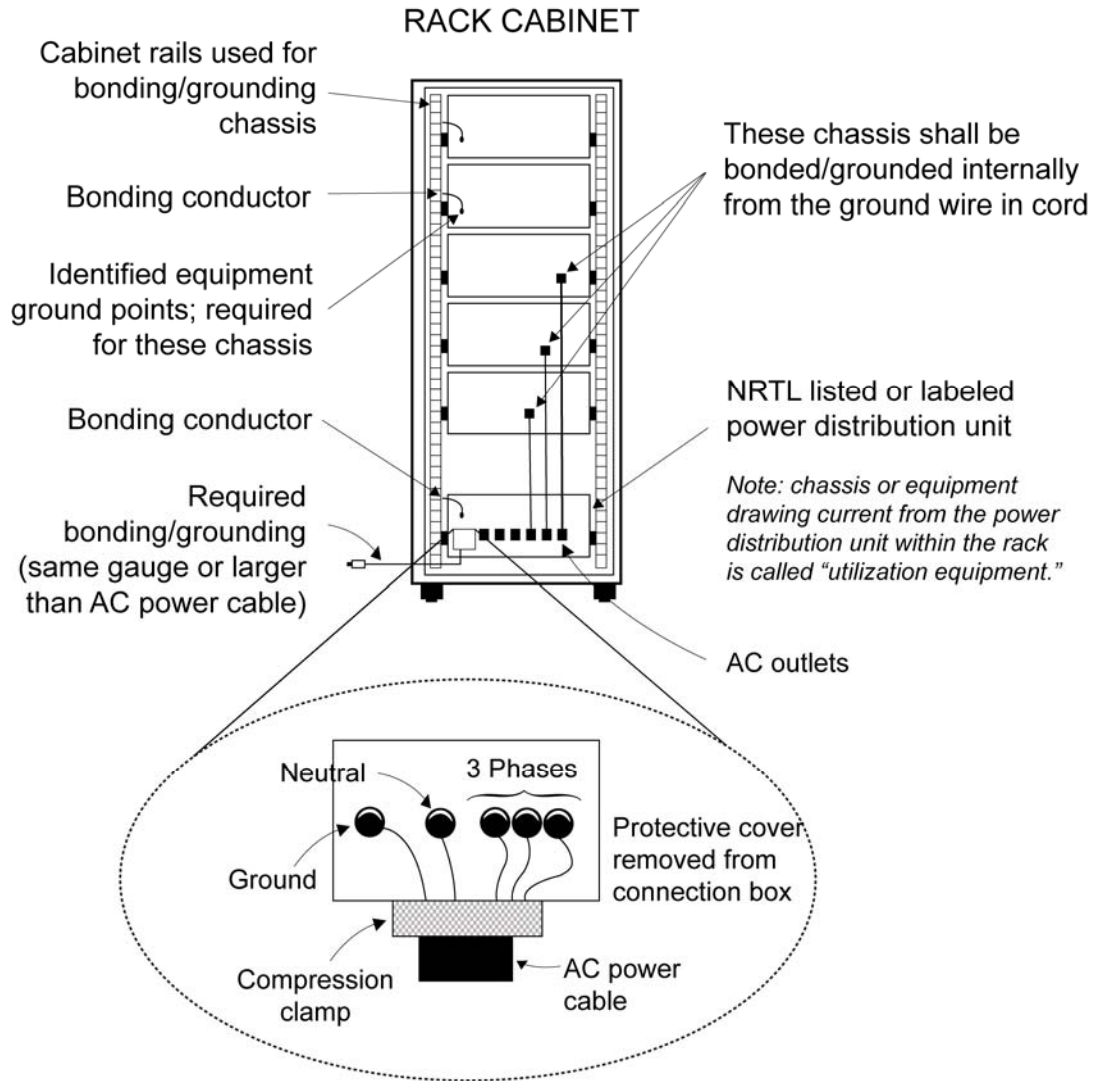

Note: This drawing represents typical 120/208 volt, 3-phase Wye, 5-wire, AC power.

Fig. 11-1. Bonding and grounding in an equipment rack.

All grounding or bonding points shall^{11.6} be tight for good continuity, identified by bare, green, or green with yellow stripe, and properly prepared by cleaning metal surfaces to bare metal, or by the use of serrated bushings. Anodized aluminum should be cleaned to bare metal.

The resistance across the bonding point shall^{11.1} be very low, so that heating stress effects, due to power loss across the bonding point, are minimized. If a measurement is necessary, the method of measurement is to be determined by the user. The user may determine a maximum resistance, e.g., 0.1 ohm.

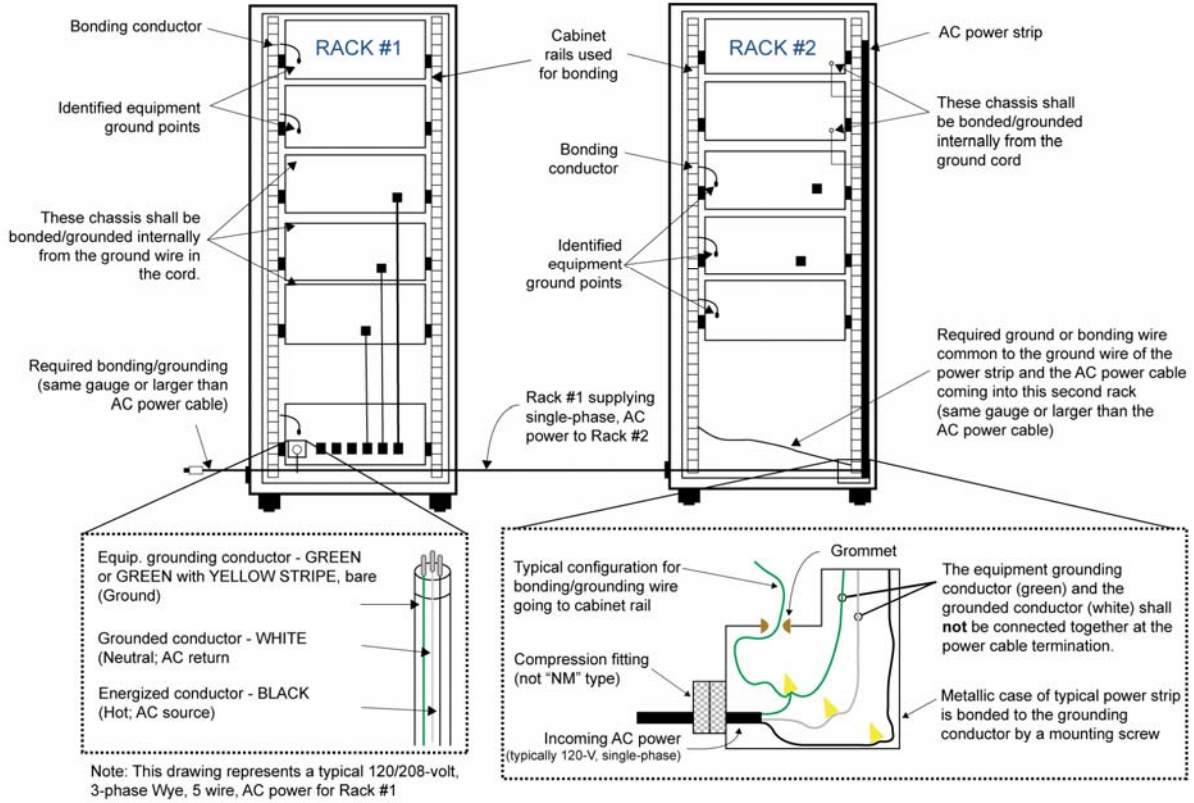
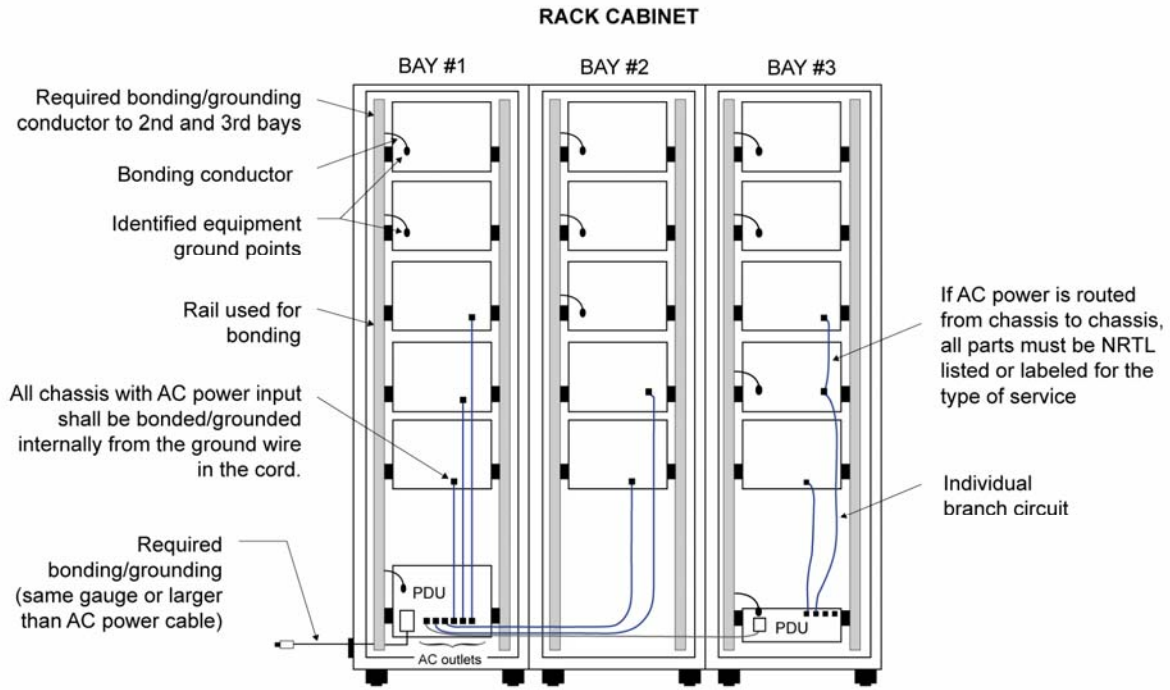

Fig. 11-2. Grounding of multiple independent racks.



Notes: PDU=Power Distribution Unit
 This drawing represents typical 120/208 volt, 3-phase Wye, 5-wire, AC power for Rack #1
 Multiple bays must be bonded together even if multiple power distribution units are installed in separate bays.

Fig. 11-3. Grounding multiple racks together.

11.1.2.1 Chassis Bonding and Equipment Grounding

Metal chassis shall^{11.7} be effectively bonded to a main grounding point in the rack cabinet where necessary to ensure electrical continuity and shall^{11.7} have the capacity to conduct safely any fault current likely to be imposed on it.

In a chassis with AC feed connected to it, the grounding terminal of its receptacle shall^{11.8} be internally bonded to the chassis frame.

If solder is used, the connection of the EGC shall^{11.9} not depend on solder alone.

11.2 RACK POWER DISTRIBUTION

The following guidelines provide the necessary information to correctly install power distribution equipment within instrumentation racks containing electrical and electronic equipment.

11.2.1 General Requirements Applying to All AC Power Equipment within or Attached to Instrument Racks

11.2.1.1 Loads

Knowledge of the loads that are to be connected within a rack cabinet is necessary and needs to be documented before starting design of a rack power distribution system. All components should be sized correctly for the loads and provide for expansion.

Equipment enclosures may or may not contain a power distribution unit. A rack power distribution unit contains a main OCPD and multiple branch circuits that are individually protected against overcurrent. Without a power distribution unit, the power wiring is considered part of one branch circuit.

Branch circuit loading shall meet the requirements of NEC Article 210.21 through 210.23.

External convenience outlets should be connected to a separate circuit breaker.

Where three-phase, four-wire service is utilized, the loads should be evenly distributed on all phases and there should be consideration of sizing the neutral conductor for certain loads (such as computer equipment) due to the presence of harmonic currents (see NEC 210.4, 220.61, and 310.10).

11.2.1.2 Other General Equipment Requirements

Rack power distribution components or assemblies shall^{11.10} be listed by an NRTL, or otherwise approved and UL 508, Section 6, construction rack (enclosure).

11.2.2 Conductors, Cords and Cables Specific Requirements.

Each type of internal or external wiring for equipment or an accessory shall^{11.11} be acceptable for the particular application when considered with respect to: (1) the current, ambient temperature, voltage, and other conditions of service to which the wiring can be subjected; and, (2) exposure to oil or grease.

The term "cables" refers to groupings of wires typically used for control signals, data, or DC or AC power. The term "cords" refers to AC power cords that are attached to devices or extension cords.

The basic insulation on each wire shall^{11.12} be rated for at least the maximum voltage to which the wire is connected, and for at least the temperature it attains. Additionally, the insulation shall^{11.13} be rated for the maximum voltage of nearby conductors and wire to which each wire may be exposed. Insulating tubing, sleeving, and tape shall^{11.12} be rated for, at least, the maximum voltage against which it insulates, and for, at least, the temperature it attains. Power and signal wires should be routed separately within a chassis.

Wires shall^{11.14} be routed away from sharp edges, screw threads, burrs, moving parts, etc. Holes through which wires are routed should have smooth, well-rounded surfaces, or should have a bushing. Clamps for guides used for routing or wiring should have smooth, well-rounded edges. Pressures exerted by such clamps should not cause cold-flow, or otherwise deform the basic insulation.

11.2.2.1 Flexible Cables

Flexible cables may be used:

1. Where flexible cables and attachment plugs are furnished by the manufacturer as part of the equipment to be mounted in the rack;
2. For connection of stationary equipment to facilitate their frequent interchange;
3. To prevent the transmission of mechanical vibration;
4. Where the fastening means and mechanical connections are specifically designed to permit ready removal for maintenance and repair;
5. For data processing cables approved as part of the data processing system; or
6. For temporary wiring.

Where breaking or loosening of a circuit connection would render an electric shock or could result in a fire, such connection shall^{11.15} be made mechanically secure. Mechanical security of connections may be provided by a crimped, closed ring, a flanged lug, or a wrapping that forms at least an open U, or by cable clamps, cable lacing, insulating tubing, or similar means.

11.2.2.2 Strain Relief

Wiring, cords, or cables shall^{11.16} be provided with strain relief, as necessary, to prevent damage.

Additional protection may be necessary if the construction of the strain relief may damage the insulation. The use of nonmetallic-sheathed cable clamps on flexible cords and cables shall^{11.17} not be permitted, unless listed and labeled for that use. The use of any metal clamp or other means that may cause undue stress on the cables within, or external, to instrument racks should not be allowed. Cord and cable support for AC power cable, or other heavy duty or large diameter cables should distribute the load over a large area of the outer covering of the cable.

11.2.2.3 Separation of Voltages

Insulated conductors of different circuits shall^{11.13} be separated or segregated from un-insulated energized parts connected to different circuits, unless provided with insulation suitable for the highest voltage involved.

Segregation of insulated conductors should be accomplished by clamping, routing, or equivalent means that provide permanent separation from insulated or un-insulated energized parts of a different circuit.

Loose strands of stranded internal wiring, connected to a wire-binding screw, should be prevented from contacting other un-insulated energized parts, not always of the same potential, as well as and from contacting noncurrent-carrying metal parts. This should be accomplished by use of pressure terminal connectors, soldering lugs, crimped eyelets, or soldering all strands of the wire together.

11.2.2.4 Other Concerns

Conductors should not be bundled together in such a way that the temperature rating of the conductors is exceeded. Bundled conductors may necessitate derating of their ampacities. For example, see NEC 310.15(B)(2) and Table 310.15(B)(2)(a).

Flexible cords shall^{11.18} be labeled and used only in continuous lengths without splice or tap when initially installed.

Repairs shall^{11.19} be permitted of hard-service cord and junior hard-service cord 14 AWG and larger, if the completed splice retains the insulation, outer sheath properties, and usage characteristics of the cord being spliced. In most instances, the entire length of flexible cord should be replaced, in order to ensure integrity of the insulation and usage characteristics.

In addition:

1. Conductors and cables shall^{11.20} be suitable for the conditions of use and location;
2. Mechanical protection shall^{11.16} be provided, where needed;
3. The environment shall^{11.21} be considered when choosing the jacket for cord/cable; and
4. It is recommended that yellow, orange or other bright cord be used when there is a potential for physical damage.

11.2.3 Power Switches and Interlock Devices Specific Requirements

For all electrical/electronic enclosures utilizing power switches or interlocks, the following apply:

1. Interlocks and/or guarding shall^{11.22} be utilized where exposed voltages (50 V or greater) are present in equipment and access to the exposed energized parts is not controlled (see Section 11.4.4);
2. All line-side unprotected contacts shall^{11.22} be guarded on interlocking contactors or other switching equipment;
3. Power switches and interlocks shall^{11.17} be suitable for the conditions, use, and location;
4. Circuit breakers used for the equipment power switch should be rated for switching under load; and
5. Provisions for lockout/tagout should be provided.

11.3 CHASSIS POWER DISTRIBUTION

Manufacturers are responsible for determining the safety of such chassis and/or enclosures and for providing documentation showing how that determination was made. Listed equipment should be selected by design, when available. Unlisted commercial equipment and in-house fabricated equipment shall^{11.23} be approved.

11.3.1 AC Power Distribution

11.3.1.1 Connections, Connectors, and Couplings

Input/output AC power connections to the chassis shall^{11.24} comply with all NEC applicable requirements.

Plugs and sockets for connecting any AC power source shall^{11.25} be NRTL-listed for the application. AC power plugs and sockets shall^{11.25} not be used for purposes other than the connection of AC power.

Connectors operating at 50 V or greater shall^{11.25} be listed, rated or recommended for their intended use.

Any connector used to provide power at 50 V or greater shall^{11.31} not allow personnel to make inadvertent contact with the power source.

If plug pins of cord-connected equipment receive a charge from an internal capacitor, the pins should not be capable of rendering an electric shock or electric burn in the normal or the single fault condition 5 seconds after disconnection of the supply. Plug-in type connectors intended to be connected and disconnected by hand shall^{11.26} be designed so that the grounding conductor connection makes first and breaks last, with respect to the other connections.

The following applies for all AC power connectors within, or external to, electrical/electronic enclosures:

1. There shall^{11.25} be no un-insulated current-carrying parts except the prongs, blades, or pins;
2. The connector shall^{11.27} prohibit mating of different voltage or current rating than that for the device intended;
3. All flexible cord, flexible cable and fixture wire connectors shall^{11.28} be protected against overcurrent in accordance with their rated ampacity;
4. Connectors shall^{11.25} be NRTL-listed for the application; and
5. Use of military standard (MS) or other non-listed connectors shall^{11.29} not be permitted except when approved.

If conditions dictate, the use of a non-NRTL listed or labeled connector, such as an MS (military standard pin and socket type) or "PT" (similar to MS, but smaller) type, for input/output AC power, a warning label should be affixed next to the connector stating: "WARNING - POWER MUST BE REMOVED BEFORE CONNECTING/DISCONNECTING."

11.3.1.2 Terminals/Energized Parts

All terminals/energized parts with a potential of 50 V or greater shall^{11.30} be guarded to protect from accidental contact or bringing conductive objects in contact with them. Consult ANSI/ISA-S82.01-1988, Table 9-1 for spacing information regarding energized parts.

All energized switching and control parts should be enclosed in effectively-grounded metal enclosures and secured so that only authorized and qualified persons can have access.

11.3.2 DC Power Distribution

Guidelines for DC power distribution include:

1. The metal chassis or cabinet should not be used as a return path; and
2. High-current analog or switching DC power supplies should use separate return paths from digital circuits.

An accessible terminal charged by an internal capacitor should be below 50 V within 5 seconds after interruption of the supply.

As with AC power, follow NFPA 70E, an energized electrical work permit shall^{11.31} be used for working on a hazardous DC energized chassis. The use of an energized work permit describing the appropriate PPE, including the class gloves, shall^{11.31} be considered when performing this type of work.

11.4 PROTECTIVE DEVICES FOR ENCLOSED ELECTRICAL/ ELECTRONIC EQUIPMENT

This section deals with the various protective devices commonly found in electrical/electronic equipment not discussed elsewhere.

11.4.1 Surge Arresters

The more common types of surge arresters used with electronic equipment are metal oxide varistors (MOV), avalanche diodes, and spark gap arresters. The type and electrical rating of the surge arrester is generally determined by the characteristics of the circuit being protected, and by the amplitude and duration of the expected surge (see ANSI/IEEE C62.11-2005).

MOVs and avalanche diodes are voltage-dependent devices whose impedance changes from a near-open circuit to a highly-conductive level when subjected to transient voltages above their rated voltages. A MOV is considered "sacrificial" in that a portion of its material is literally burned off each time such a surge is encountered. The response time of an MOV is limited to approximately 500 picoseconds, while avalanche diodes can respond in approximately 50 picoseconds. Lead lengths can greatly increase the response times of these devices. The normal failure mode of both devices is a short circuit, although sustained voltages, well beyond the rating of the MOV, can cause the device to rupture and result in an open circuit. A surge arrester should be connected between each ungrounded conductor and ground.

For power line applications, MOV manufacturers recommend that a varistor be used with a fuse that limits the current below the level that MOV package damage could occur. In general, circuit breakers are not recommended for this application since circuit breaker tripping is too slow to prevent excessive fault energy.

Consult the manufacturer's application data sheets for more information.

11.4.2 Fuses

Fuses are temperature-sensitive, current-sensing elements that are generally used as short circuit protective devices in an individual electrical chassis. The fusing characteristic, or opening time versus current, should be within the safe time/temperature characteristic of the device being protected.

Designers should carefully consider the load demands in the fuse selection process, particularly when high surge currents may be encountered during initial turn-on. Operating time/current characteristics of the various types available can usually be found in fuse manufacturers catalogs. A fuse's interrupting current capacity shall^{11.32} also be considered when connected to a power distribution system having a significant fault current capacity.

The voltage rating on a fuse shall^{11.32} be equal to, or greater than, the device's operating voltage.

In general, cartridge fuses should have a disconnecting means on the supply side, per NEC 240.40, and shall^{11.33} not be connected in parallel, unless they are factory-assembled and listed as a unit.

11.4.3 Circuit Breakers

A chassis or cabinet should not employ circuit breakers as "on/off" switches, unless rated for the application by the manufacturer.

11.4.4 Power Interlock Devices

Cabinets and equipment having potentially dangerous currents and/or voltages present should have a means of controlling access, or a power interlock device designed to interrupt the power to the cabinet. Provisions shall^{11.34} be made to discharge any stored energy from capacitors or inductors to less than 50 V within 5 seconds when the safety interlock is opened. Interlocks may not be used as a substitute for lockout/tagout.

11.5 DISCONNECTING MEANS

All enclosed electrical/electronic equipment shall^{11.35} be provided with a means for disconnecting them from each external or internal operating energy source. This disconnecting means shall^{11.35} disconnect all current carrying conductors.

11.5.1 General

Interlock systems shall^{11.36} not be used as a disconnecting means for cabinets and equipment having potentially dangerous currents and/or voltages present.

Permanently connected equipment and multi-phase equipment should employ a listed switch or circuit breaker as means for disconnection.

All cord-connected equipment should have one of the following as a disconnecting device:

1. A switch or circuit breaker;
2. Plug that can be disconnected without the use of a tool; or
3. A separable plug, without a locking device, to mate with a socket-outlet in the building.

If equipment is connected to the source of supply by flexible cords having either an attachment or appliance plug, the attachment or appliance plug receptacle shall^{11.37} serve as the disconnect.

If a disconnecting means is not part of the equipment, the disconnecting means should be near the equipment, within easy reach of the operator during normal operation of the equipment, and marked as the disconnection device for the equipment.

If a disconnecting device is part of the equipment, it should be located as close as practical to the input power source.

11.5.2 Emergency Shutdown

The emergency shutdown switch should: be within arm's reach of the operator; be easily identifiable; be capable of de-energizing all power to all equipment associated with the system; be separate from the routine on/off switch; and, be located to protect the employee from moving parts. However, the emergency shutdown switch should not disconnect auxiliary circuits necessary for safety (such as cooling).

11.5.3 Special Considerations

The disconnecting means shall^{11.38} interrupt the source voltage for secondary or remote controlled equipment, such as that using thyristor controls. NOTE: Disconnecting the control voltage shall^{11.38} be considered sufficient.

11.6 MARKING AND LABELING REQUIREMENTS

11.6.1 General Marking Requirements

For all chassis and rack cabinets (electrical, computer, power distribution, etc.), the manufacturer's name, trademark, or other descriptive marking of the organization responsible for the product shall^{11.39} be identified.

Other markings for consideration include:

1. Voltage;
2. Maximum rated current in amperes;
3. Wattage;
4. Frequency;
5. Duration;
6. Duty cycle; and
7. Other ratings as specified in the NEC (NEC 110.21).

11.6.2 Hazard Marking Requirements

All enclosures containing exposed energized circuits over 600 V nominal shall^{11.40} be marked "Danger High Voltage Keep Out" with a label that is permanent. These areas shall^{11.41} be accessible to authorized personnel only. The label shall^{11.41} be placed in a noticeable location on the access panel to the enclosure. All other hazards that are associated with the equipment should be marked.

11.6.3 Other Requirements

All equipment markings shall^{11.42} be of sufficient durability to withstand the environment involved.

To obtain the correct chassis load parameters for marking and labeling, individual chassis should be labeled while under load. Many chassis have components that are not energized, except under certain conditions.

A normal current draw may be a few amperes, but when the chassis is sourcing current to a load, the current draw may be much higher. Individual loads, internal and external, may be tabulated and added to determine the chassis current labeling information.

For rack cabinets with internal power distribution units, the outside of the rack cabinet should be labeled with the input parameters of the internal power distribution system.

For rack cabinets without internal power distribution units, the outside of the rack cabinet should be labeled with the total current of the installed equipment.

11.7 WORKING CLEARANCE

Clear working space and headroom shall^{11.43} meet the NEC requirements. The clear working space and passageways to this space shall^{11.43} not be used for storage. At least one entrance of sufficient area shall^{11.43} be provided to give access to working space around electrical equipment.

While maintenance, repair, or calibration, is being performed, personnel should identify clear working spaces via suitable means, such as "Danger" or "Caution" barrier tape, or barricades to keep other personnel from entering the clear working spaces.

Figures 11-4 and 11-5 provide depictions of the top view and the side view of equipment layout illustrating clearances.

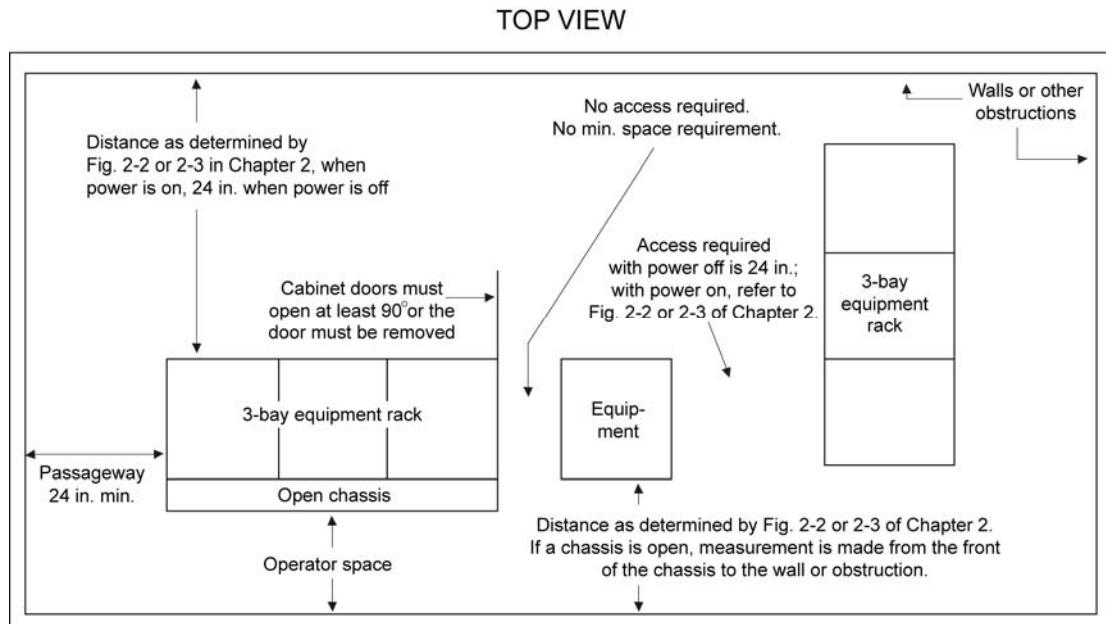

Fig. 11-4. Top view of equipment layout illustrating working clearances.

SIDE VIEW

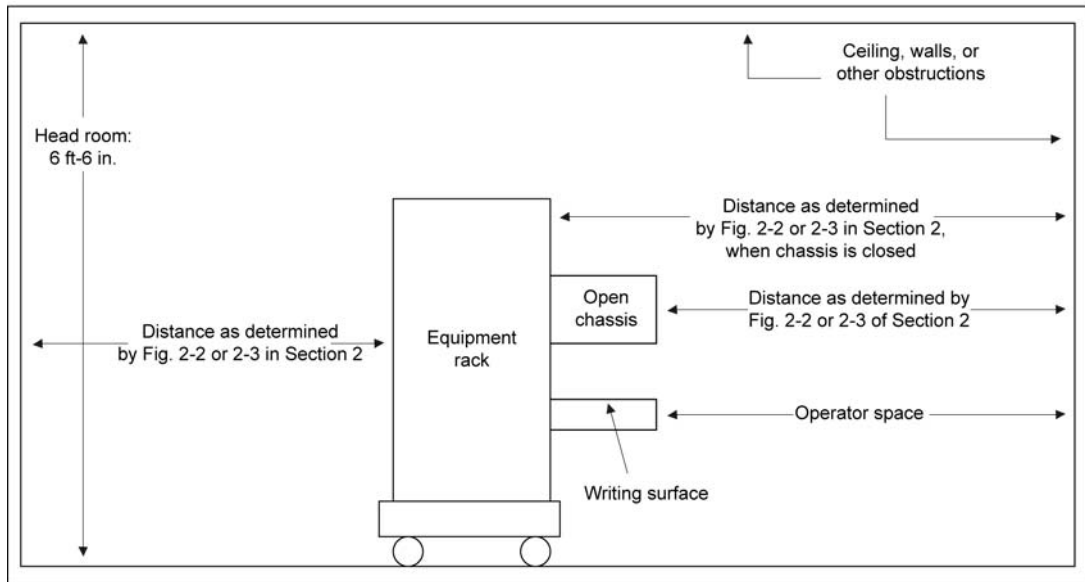

Fig. 11-5. Side view of equipment layout illustrating working clearances.

11.8 CABLE/UTILITY MANAGEMENT SYSTEM

11.8.1 Usage with Enclosed Electrical/Electronic Equipment

In certain locations, cable supports and/or enclosures are installed for dedicated use with enclosed electrical/electronic equipment. In such cases, the use of a cable/utility management system is a part of custom-made equipment (see Figure 11-6). It is acceptable for these cable/utility management systems to be used to support bundles of cables, hoses, and tubing that run from the equipment console to the unit under test.

In cable/utility management systems where cables (other than those of the custom equipment, exist) steps should be taken to ensure that no damage to the existing cables can occur, and that the collocation of the cables does not create additional hazards.

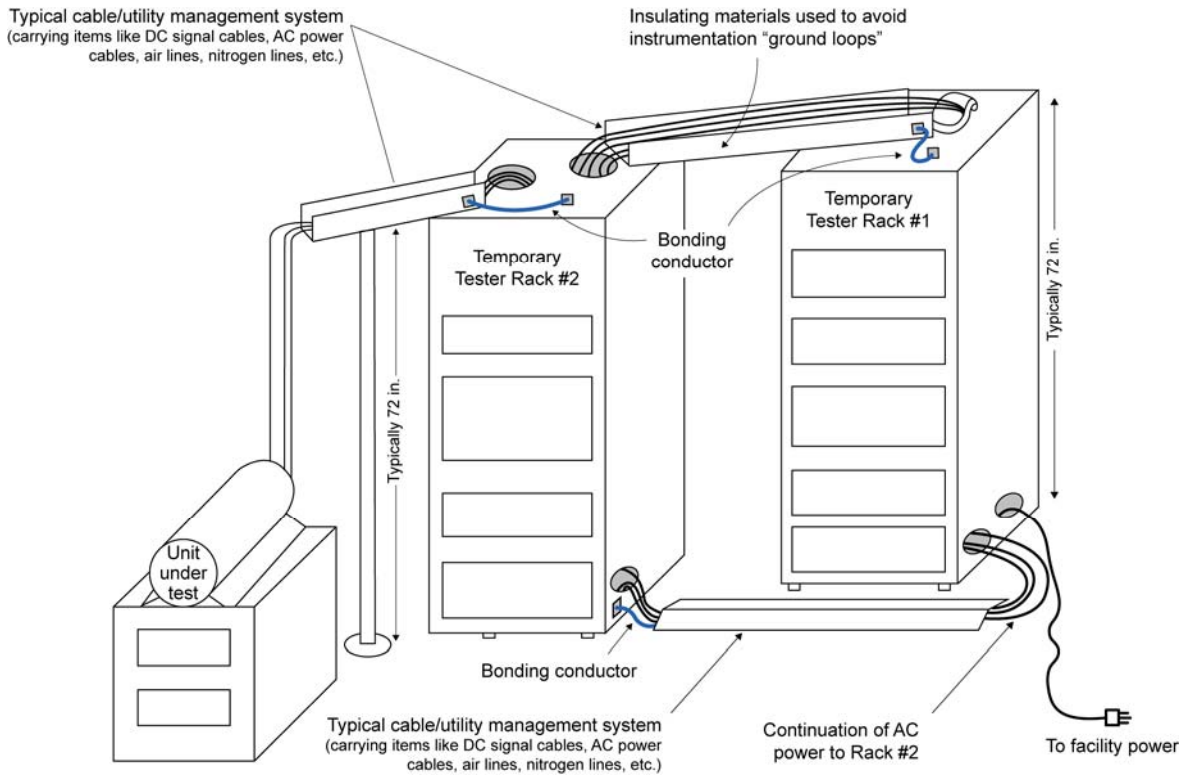

Fig. 11-6. Example of cable management in laboratory.

11.8.2 Requirements

1. The following requirements and recommendations relate to installation and use of utility cable tray systems:
 - a. Cable tray systems shall^{11.44} be grounded.
 - b. Cable tray systems shall^{11.44} be engineered and properly installed so as to preclude mechanical failure under anticipated load conditions.
 - c. Cable tray systems shall^{11.44} not have sharp edges.
 - d. Caution should be exercised when adding cables or other services to existing trays to insure that installed cables are not crushed, abraded, or otherwise damaged.
 - e. Mechanical fastening of cables to the cable tray structure or to other cables in the cable tray system should be minimized. Excessive fastening unnecessarily constrains the addition or removal of cables at future times. It is recognized, however, that mechanical fastening of certain cable installations is necessary to limit movements associated with EM forces.
 - f. It is recommended that all unused cables be removed from existing cable tray systems. It is recognized, however, that such removal may be precluded if existing operational cables would be adversely affected by the removal process.
 - g. Cable trays should not be utilized for storage of excessive lengths of installed cables. Cables should be dressed to suitable lengths upon installation.
 - h. It is recognized that in many locations, due to limited space, the cable tray system offers the best means of bringing services to support experimental devices. In all

cases, neither the mechanical loading nor the ventilating capability of the installed cable tray system shall^{11.45} be significantly compromised by addition of such services.

- i. Flammable gas lines shall^{11.46} not be permitted to be located in cable trays.
 - j. Utilization equipment should not be located in cable tray.
 - k. For instances of where premise wiring is to be installed in a utility cable tray, such wiring shall^{11.47} be installed in accordance with the NEC. The installation of premise wiring should be segregated through the use of tray dividers.
 - l. For installations of signal cable into a power cable tray, the responsible engineer should consider the cable for thermal and electrical properties in consideration of the specific installation and the cable tray for structural integrity. All installations in power cable tray shall^{11.48} follow the NEC guidelines for cable tray fill.
 - m. For installations of cable into a utility cable tray, the responsible engineer should take into account the structural load capability of the cable tray system and the durability of the existing cables. The nature of signal circuits is such that the energy carried by the cables is relatively low. Accordingly, the resultant losses in signal cables are of a sufficiently low level that heat dissipation is not a problem.
 - n. Non-flammable gas lines which are neatly bundled and secured shall^{11.49} not be installed in utility cable tray or attached to the utility cable tray supports (not attached to the tray itself).
 - o. Cable trays shall^{11.50} be made of corrosion-resistant material or adequately protected from corrosion that may be encountered in use. Refer to manufacturers' literature.
 - p. Verify that the building structure has adequate capacity to support the fully loaded cable tray(s). An appropriate safety factor should be applied to account for stresses during installation of cables, stresses during seismic events, and uncertainties about the building structure.
 - q. Provide protection for cables from deteriorating agents (see NEC 392.5(C)).
2. The following requirements and recommendations relate to installation and use of cable tray systems in pulsed power applications:
- a. Cable tray systems shall^{11.51} be grounded in a way such that inductive effects are minimized during a fault condition so that voltage rise along the ground path is also minimized.
 - b. The cable tray should be designed and installed to minimize inductive effects during a fault condition.

An assessment of any hazards identified with the equipment, as well as the operation in which it is involved, shall^{11.49} be performed to ensure the safe operation of components in the cable/utility management system.

Metallic cable/utility management systems that support electrical conductors shall^{11.51} be grounded or bonded to the equipment. A qualified worker should inspect all components with exposed metal parts to check for grounding integrity. This inspection should be documented. When cable/utility management systems are installed exclusively for electrical/electronic equipment usage, and when these trays are metallic and not grounded or bonded, approved

documentation should exist stating the reason for not grounding or bonding the system. (See Section 11.3.)

Equipment cable/utility runs installed in cable/utility management systems should be visually inspected periodically. These inspections should be performed at the time of installation, and at any interval specified in the equipment documentation. Any inspection should, as a minimum, consist of:

1. A visual check for the integrity of cable jackets and visible shields;
2. A check for the integrity of all utility hoses by looking and listening for leaks;
3. A visual check on all securing devices used to hold the bundle on the tray to assure the bundle is positioned properly and no damage has occurred;
4. A visual inspection on all bends for signs of pinching, cutting, exceeding minimum cable bending radius, or other damage; and
5. Documentation of all results of any inspection.

Supports shall^{11.52} be provided to prevent stress and physical damage to cables where they enter or exit cable/utility management systems.

11.9 ELECTRICAL SAFETY REQUIREMENTS FOR TESTER FACILITIES

The following section is not intended to encompass all of the electrical design requirements that need to be considered in planning electrical systems for facilities intended to accommodate testers. The information provided in this section should, however, provide a guide for personnel who would be tasked with specifying facility electrical safety necessary to the testing environment.

Provisions for an adequate number of receptacle outlets and associated branch circuits to accommodate cord and plug-connected equipment, testers, etc., in a facility should also be considered in specifying the electrical supply.

For equipment where continuity of service is critical, consideration should be given to the use of a continuously operating or standby uninterruptible power supply (UPS) or a generator.

11.9.1 Ampacity of Facility Wiring and Distribution Equipment

Consideration should be given to accommodating the anticipated load demand which may occur as a result of power supplied to the various possible combinations of electrical equipment connected to a particular branch circuit.

11.9.2 Facility Grounding at Temporary or Remote Sites

Proper grounding is considered crucial to providing the safest possible electrical installation, from the standpoint of maximizing the safety of facility occupants and minimizing property damage and loss.

Designs for equipment to be used at temporary or remote sites should take into consideration the same grounding issues that may not be accommodated in the same manner as for permanent facility power wiring.

11.9.3 Facility Lightning Protection

Lightning protection is recommended for facilities that house enclosed electrical/electronic equipment involved with radioactive, explosive, and similarly hazardous materials, or for facilities that are considered valuable or house valuable contents.

11.9.4 Surge Protection

In addition to facility lightning protection, the effects of surges resulting from lightning strikes to power distribution systems may be lessened by the use of lightning arrestors and suppressors installed at strategic points in the supply system to the facility. An assessment addressing the consequences of lightning-induced surges is necessary in order to determine the degree to which protection should be provided.

11.10 ENCLOSED POWER ELECTRONICS

Power electronics equipment is equipment that uses electronic components and subsystems to control significant amounts of electrical energy. Examples of power electronics systems include:

1. Power supplies and modulators for laser systems;
2. Accelerators, magnets, x-ray systems, and other research equipment;
3. Radio and radar transmitters;
4. Variable speed motor drives; and
5. Induction heating systems.

Due to the hazards involved with this type of equipment all applicable portions of this section should be addressed.

11.10.1 Enclosures

Power electronics equipment should be constructed in all-metal enclosures for containment of fire, high energy, and electromagnetic radiation hazards.

The enclosures should support the housed equipment, provide strength to brace conductors against short circuit forces, and protect housed equipment against physical damage.

It is usually easier to provide barriers to protect the electronics enclosure from collision rather than to strengthen the enclosure itself.

11.10.2 Component Clearances

Enclosures shall^{11.53} provide adequate clearance from energized parts. Specified clearances depend on the shape of the conductor, the surface characteristics of the conductor and enclosure, the voltage characteristics, environmental conditions, and creepage. Larger clearances may be necessary around support insulators due to their surface breakdown characteristics.

All power electronics enclosures shall^{11.54} provide adequate room for access to parts and subsystems for expected maintenance and modification. Consideration should be given to handling provisions for heavy parts and subsystems, access to test points and calibration adjustments, and work clearances for safe access to enclosure interiors.

Safe work on high-voltage equipment includes installation of manual grounding devices on exposed high-voltage conductors. Enclosure size should provide adequate room to safely apply and remove grounding devices, and permit grounding devices to remain in place without interfering with expected work.

Enclosures should be sized to allow cables to be installed and routed without infringing on required clearances from high-voltage conductors.

Subassemblies, circuits, and related equipment should be segregated to the extent possible to minimize the possibility of a fault in one device damaging another.

11.10.3 Instrumentation

Power electronics systems can involve fast pulses, high frequencies and high currents and it is common for the voltage difference between ground in one circuit and ground in another circuit to differ substantially. This difference can be hundreds or thousands of volts. Wire and cable shall^{11.55} be insulated to withstand these potentials. Surge arrester and capacitor protection may be used to control these potentials. DC circuits connected to coils, solenoid valves and other inductive components should be tested for induced voltages and appropriate protection for circuits should be provided.

11.10.4 General

Test points needed for adjustment and diagnosis should be installed on the front panel, or other appropriate location, of power electronic systems to facilitate their use without exposure hazard to employees in the area.

Currents generated only during fault conditions, or those introducing noise or data errors, shall^{11.4} not be considered objectionable currents. However, bonding and grounding may be altered to reduce the noise or data errors, provided the provisions of NEC are maintained. Conductors, bus bars, and internal wiring should be insulated in the event objects are dropped into the equipment.

Automatic discharge devices are not a substitute for grounding devices used for personnel protection. Equipment grounding points shall^{11.56} be located in the system and physically arranged to permit the attachment of adequate equipment grounding devices for the protection of personnel working on the system.

These grounding points shall^{11.57} be capable of carrying the short-circuit current to which they may be subjected and applied using methods appropriate for the voltages or currents involved.

11.11 NON-IONIZING RADIATION

11.11.1 Electromagnetic Radiation

Human exposure to EM radiation (EMR) at certain power-density levels can be hazardous. The hazards are associated with the heating of biological tissue, which occurs when EM radiation is absorbed by the body. This heating is essentially similar to the cooking process in a microwave oven. Use caution where EM sources are being used with the shielding altered or removed.

When working with EMR, it is recommended that calculations be performed to estimate the emitted radiation levels. Actual levels are measured by radiation monitors.

EMR-safe levels have been established by the IEEE and are documented in the IEEE Standard – C95.1-1999, *Standard for Safety Levels with Respect to Human Exposure to Radio Frequency Electromagnetic Fields, 3 kHz to 300 GHz*.

Exposure to hazardous levels of EMR can be lessened by maintaining as much distance as possible from the source. Power density is reduced by a factor of $1/\text{distance}^2$ from the source.

11.11.2 Electromagnetic Radiation Threat to Electro Explosive Devices

Designers of enclosed electrical/electronic equipment should consider the possible effects on nearby electro explosive devices (EED) of EMR (i.e., radio frequency (RF) energy, emitted by that equipment).

Energy induced into an EED by the EM field resulting from such emissions may be adequate to cause the device to detonate.

Factors that should be taken into account in assessing concerns for possible EMR emissions are:

1. Wiring, shielding, and sensitivity;
2. Proximity;
3. Frequency of the emissions;
4. Power density; and
5. Type of emission modulation.

Possible measures to mitigate the threat of EMR emissions include:

1. Enclosure and signal line shielding and grounding to prevent leakage of EMR from the equipment;
2. Designed-in physical separation or barrier that would ensure that the power density of the EM field is inadequate to cause detonation of an EED at the closest possible distance to the emission source within the equipment;
3. Filter, or provide ferrite beads for, signal lines from the equipment which may conduct EMR emissions into the EED circuitry;
4. Ensure that the minimal power necessary is used to operate circuitry capable of producing EMR;
5. Label the equipment capable of emitting EMR to indicate the minimum separation distance to be maintained between the equipment and an EED (or EEDs); and
6. Use a safety factor in design for EMR reduction (e.g., some designers permit only 1/10 of the energy that would initiate an EED).

11.12 AMPACITY INFORMATION FOR WIRE SIZING

The following information is useful for designing wiring for electronic equipment.

11.12.1 Ampacity Information

Sources of information for determining ampacity of wiring and cable include:

1. IEEE Standard 835, *IEEE Standard Power Cable Ampacity Tables*
2. IEEE Standard 848, *Procedure for the Determination of the Ampacity Derating of Fire Protected Cables*
3. Insulated Cable Engineers Association (ICEA) ICEA P-54-440, NEMA Pub. No. WC 51 - *Ampacities of Cables in Open-Top Trays*
4. NFPA 70

Cable manufacturers provide different current carrying numbers based on the insulation used for the wire.

Table 11-1 lists copper wire with a Teflon (TFE) insulation. TFE insulation has a higher operating temperature range than other insulators such as PVC. The table below is based on data derived from cancelled MIL-STD-975, *NASA Standard EEE Parts List*, using 70° C as the operating temperature. To date based on number of wires in a bundle:

$$I_{BW} = I_{SW} \times (29 - \#_{\text{wire}}) / 28 \text{ @ [1 to 15 Bundled wires]}$$

$$I_{BW} = I_{SW} \times (0.5) \text{ @ [more than 15 Bundled wires]}$$

I_{SW} = Single wire

I_{BW} = Bundled wires

To derate by temperature use; derate by 80% at 150° C, 70% at 135° C, or 50% at 105° C.

Copper Wire TFE Insulated			
AWG	Current Carrying	AWG	Current Carrying
00	169	0	147
2	108	4	81
6	60	8	44
10	33	12	25
14	19	16	13
18	9.2	20	6.5
22	4.5	24	3.3
26	2.5	28	1.8
30	1.3	-	-

Table 11-1. Ampacity for TFE insulated copper wire.

11.12.2 Color Coding Guidelines

This subsection describes wire insulation color coding as defined by current military specifications. Insulation color coding is used to indicate wire function or the voltages present.

The NEC specifies the color coding system for premise and facility wiring as described in NEC 200.6, 200.7, 210.5, 250.119, et al.

The NFPA specifies insulation colors for industrial machinery (machine tools). The NFPA 79 color scheme uses a solid color with another color strip for a number of applications. For details, see NFPA 79, *Electrical Standard for Industrial Machinery*.

Table 11-2 provides hook-up wire color coding for chassis and interconnecting wiring. The military standard color identification number is addressed in Table 11-5.

Colors for chassis and interconnecting wiring system by function				
Function	Base Color	Identification #	Alternate color code	Identification #
Grounds, Grounded Elements	Green	5	Green	5
Heaters or Filaments	Brown	1	White/brown	91
Power Supply B+	Red	2	White/red	92
Screen Grids Clock	Orange	3	White/orange	93
Transistor Emitters	Yellow	4	White/yellow	94
Transistor Bases	Black	0	White/black	90
Transistor Collectors	Blue	6	White/blue	96
Power Supply, minus	Violet	7	White/violet	97

Table 11-2. Color codes for chassis and interconnecting wires.

Table 11-3 specifies optical fiber cable color coding according to the Electronic Industries Alliance in EIA Standard 598-A, *Optical Fiber Cable Color Coding*. EIA Standard 598 specifies color codes of the cables when they are grouped into bundles.

EIA598 Fiber Color Chart	
Position Number	Color & Tracer
1	Blue
2	Orange
3	Green
4	Brown
5	Slate
6	White
7	Red
8	Black
9	Yellow
10	Violet
11	Rose
12	Aqua
13	Blue with Black Tracer
14	Orange with Black Tracer
15	Green with Black Tracer
16	Brown with Black Tracer
17	Slate with Black Tracer
18	White with Black Tracer
19	Red with Black Tracer
20	Black with Yellow Tracer
21	Yellow with Black Tracer
22	Violet with Black Tracer
23	Rose with Black Tracer
24	Aqua with Black Tracer

Table 11-3. EIA598 Fiber Color Chart.

Table 11-4 specifies optical fiber cable color coding when there is more than one type of cable in the jacket.

Color coding of Premise Fiber Cable		
Fiber Type / Class	Diameter (μm)	Jacket Color
Multimode 1a	50/125	Orange
Multimode 1a	62.5/125	Slate
Multimode 1a	85/125	Blue
Multimode 1a	100/140	Green
Singlemode IVa	All	Yellow
Singlemode IVb	All	Red

Table 11-4. Color coding of premises fiber cable.

Table 11-5 specifies the military standard for AC wiring color coding

Color Coding for AC Wiring					
Service	Phase A	Phase B	Phase C	Neutral	Ground
115v 60Hz 1 ϕ	Black	---	---	White	Green
208v 60Hz 3 ϕ "Y"	Black	Red	Orange or Blue	White	Green
230v 60Hz 3 ϕ Delta	Black	Red	Orange or Blue	---	Green
115v 400Hz 3 ϕ Delta	Black	Red	Orange or Blue	---	Green
208v 60Hz 3 ϕ "Y"	Black	Red	Orange or Blue	White	Green

Table 11-5. Color coding for AC wiring per military standard.

Table 11-6 specifies color coding standards for commercial AC wiring, including flexible power cords.

Commercial Coding for AC Wiring			
Service	US	Europe	UK
115v/240v 60Hz	Black	Brown	Brown
Common	White	Blue	Blue
Ground	Green	Green/Yellow	Green/Yellow

Table 11-6. Commercial color code for AC wiring.

12.0 APPROVAL OF UNLISTED ELECTRICAL EQUIPMENT

Electrical conductors and equipment installed or used shall^{12.1} be listed/labeled or acceptable if approved by the AHJ. Using the following criteria:

1. If it is accepted, or certified, or listed, or labeled, or otherwise determined to be safe by an NRTL recognized pursuant to 29 CFR 1910.7;
2. With respect to an installation or equipment of a kind that no NRTL accepts, certifies, lists, labels, or determines to be safe, if it is inspected or tested by another federal agency, or by a state, municipal, or other local authority responsible for enforcing occupational safety provisions of the NEC, and found in compliance with the its provisions; and
3. With respect to custom-made equipment or related installations that are designed, fabricated for, and intended for use by a particular customer, if it is determined to be safe for its intended use by its manufacturer on the basis of test data, and the AHJ approves.

See Appendix C of this Handbook for an example of a program that may be evaluated for use to provide a basis for approval of electrical equipment.

13.0 RESEARCH & DEVELOPMENT

The DOE complex engages in a variety of R&D activities that often incorporate the design and use of special or unusual apparatus and equipment in its facilities. Even with these specialized R&D needs, the workplace shall^{13.1} be maintained free of known hazards that cause, or are likely to cause, death or serious injury. Special efforts may be necessary to ensure adequate electrical safety, beginning with design and continuing through development, fabrication and construction, modification, installation, inspection, testing, operation, and maintenance of R&D electrical apparatus and facilities. This section provides guidelines that may be used to complement existing electrical codes and recognized industry standards in conformance with DOE orders and OSHA requirements.

This section contains safety criteria for the DOE complex in the design, development, fabrication and construction, modification, installation, inspection, testing, operation, and maintenance of R&D electrical apparatus and facilities. Personnel safety shall^{13.2} be the primary consideration. When conflicts between electrical codes, recognized industry standards, DOE orders, or regulations arise, the requirement that addresses the particular hazard and provides the greater personnel safety protection governs.

This section attempts to address R&D electrical systems which are not specifically addressed elsewhere in this Handbook. The electrical environment of the DOE complex is extremely varied, ranging from low-voltage electronic circuits to common office and industrial electrical systems to large, high-voltage power distribution systems to high-voltage/low-current and low-voltage/high current systems associated with R&D programs. Electrical systems of all types are an integral part of R&D operations and associated support work.

13.1 OPERATION AND MAINTENANCE

Maintenance procedures and schedules should be developed for R&D equipment. Electrical equipment shall^{13.3} be checked, cleaned, and maintained on a schedule and in a manner based on its application and use. Additional information is provided in Section 4.0.

13.2 EMPLOYEE QUALIFICATIONS

This section provides guidance for determining the qualification process for persons involved with specialized electrical equipment, configurations or work tasks associated with experiments. The guidance provided in this section is in addition to the minimum qualifications described in Section 2.7.

13.2.1 Hazards

The hazards associated with R&D equipment are sometimes unique because the equipment itself is unique. These hazards are sometimes made worse because of an uncommon design or the fact that it may be one of a kind. Special efforts are, therefore, necessary to identify all the potential hazards that may be present in a specific unique design. These hazards should be identified, and a plan developed to mitigate the associated risk. Personnel working on R&D equipment shall^{13.4} be qualified to work on this equipment.

13.2.2 Additional Qualifications

Personnel assigned to tasks involving R&D equipment shall^{13.5} be apprised of the hazards associated with the equipment and assigned task. It is suggested that they participate in developing mitigation plans to reduce the risks associated with the hazards.

A list of additional experience qualifications should be developed by the appropriate personnel including the workers. This list should identify specific training necessary for unusual equipment or tasks.

13.3 GENERIC R&D EQUIPMENT

There are many possible types of electrical AC and DC power source hazards in complex R&D systems. As a result, the various design philosophies preclude establishing hazard classifications based on voltage alone.

13.3.1 Power Sources

13.3.1.1 Hazards

1. Internal component failure can cause excessive voltages. Internal component open-circuit failure in capacitor banks and Marx generators can result in full voltages across components that may not be appropriately discharged in the usual manner.
2. Internal component shorts in capacitor banks and Marx generators can result in excessive fault current, causing extreme heat, over pressurization of capacitor enclosures, and rupture.
3. Overloading or improper cooling of power supplies can cause excessive temperature rise.
4. Output circuits and components can remain energized after input power is interrupted.
5. Auxiliary and control power circuits can remain energized after the main power circuit is interrupted.
6. When power supplies serve more than one experiment, errors made when switching between experiments may create hazards to personnel.
7. R&D electrical apparatus may contain large amounts of stored energy, requiring fault analysis.
8. Liquid coolant leaking from R&D electrical equipment may pose an electrical hazard to personnel.

13.3.1.2 Design and Construction

In design and construction of R&D equipment, it is important to remember the following cautions:

1. Only components essential to the power supply should be installed within the power supply enclosure.
2. Appropriate separation between high-voltage components and low-voltage supply and/or control circuits shall^{13.6} be provided, if required.
3. A visible indicator that the power supply is energized should be provided to personnel.

4. The number of control stations should be minimized.
5. An emergency shutdown switch should be provided, where needed.
6. Multiple input power sources should be avoided, where possible.
7. A label containing emergency shutdown instructions should be applied to equipment that is remotely controlled or unattended while energized.

13.3.1.3 Operation and Maintenance

Before working in a power supply enclosure or an associated equipment enclosure, personnel shall^{13.7,13.8,13.9.}

1. Implement lockout/tagout;
2. Check for auxiliary power circuits that could still be energized;
3. Inspect automatic shorting devices to verify proper operation; and
4. Short the power supply from terminal-to-terminal and terminal-to-ground, with grounding hooks.

13.3.2 Conditions of Low-Voltage and High-Current

13.3.2.1 Hazards

It is usual for R&D facilities to have equipment that operates at less than 50 V AC. Although this equipment is generally regarded as non-hazardous, it is considered hazardous when high currents are involved. Examples of such equipment are a power supply rated 3 kiloampere (kA) at 25 V, a magnet power supply with rated output of 200 A at 40 V, and a bus bar carrying 1 kA at 5 V.

Though there is a low probability of electric shock at voltages less than 50 V AC (see Appendix D, Table D-1), there is a hazard due to arcing and heating in case of an accidental fault. For example, a tool could drop onto the terminals and initiate an arc; causing severe burns (see section 2.2.2).

13.3.2.2 Design and Construction

A circuit operating at more than 50 V shall^{13.10} be treated as a hazardous circuit if the power in it can create electrical shocks, burns, or an explosion due to electric arcs. Observe all of the following rules for such circuits:

1. Protective covers and/or barriers shall^{13.11} be installed over terminals and other energized parts to protect personnel.
2. Suitable markings shall^{13.12} be applied to identify the hazard at the power source and at appropriate places.
3. Magnetic forces, in both normal-operation and short-circuit conditions, should be considered. Conductors that have appropriate physical strength, and are adequately braced and supported to prevent hazardous movement, should be used.
4. Inductive circuits may create high-voltage hazards when interrupted. Circuit design should include a method to bleed off power safely, should an interruption occur.

13.3.2.3 Operation and Maintenance

These guidelines for working on circuits operating at 50 V AC, or less, or at 100 V DC, or less, that are treated as hazardous shall^{13.13,13.14} be followed:

1. Work on such circuits when they are de-energized; and
2. If it is essential to work on or near energized low-voltage, high-current circuits, operating at more than 50 V, observe the safety rules as if the circuits were operating at higher voltages. Refer to Section 2.1.2, *Considerations for Working on Energized Systems and Equipment* and 2.12, *Work Practices*.

13.3.3 Conditions of High-Voltage and Low-Current

13.3.3.1 Hazards

When the output current of high-voltage supplies is below 5 mA, the shock hazard to personnel is low. Where combustible atmospheres or mixtures exist, the hazard of ignition from a spark may exist. High-voltage supplies (AC or DC) can present the following hazards:

1. Faults, lightning, or switching transients can cause voltage surges in excess of the normal ratings.
2. Internal component failure can cause excessive voltages on external metering circuits and low-voltage auxiliary control circuits.
3. Overcurrent protective devices, such as fuses and circuit breakers for conventional applications, may not adequately limit or interrupt the total inductive energy and fault currents in highly inductive DC systems.
4. Stored energy in long cable runs can be an unexpected hazard. Safety instructions should be in place to ensure proper discharge of this energy.
5. Secondary hazards, such as startle or involuntary reactions from contact with high-voltage low-current systems, may result in a fall or entanglement with equipment.

13.3.3.2 Design Considerations

Personnel in R&D labs may encounter energized parts in a variety of configurations, locations, and under environmental conditions that are not usual for most electrical power personnel. Sometimes the equipment can be designed to incorporate mitigation of the hazards associated with working on such equipment. If not, safe operating procedures should be developed and used.

13.3.3.3 Safety Practices

An analysis of high-voltage circuits should be performed by a qualified person before work begins, unless all exposed energized parts are guarded. The analysis should include fault conditions in which circuit current could rise above the nominal rated value. Depending on the results of the analysis, any of the following may apply:

1. If the analysis concludes that the current is above 5 mA or stored high-voltage capacitive energy is above 1 J for voltages between 100 and 400 V DC, or above 0.25 J for voltages equal to or greater than 400 V, then the work is considered to be energized work and shall^{13.15} be performed in accordance with Section 2.0, General Requirements, of this Handbook.

2. If the analysis concludes that the current is between 0.5 mA and 5 mA and between 0.25 and 1 J, then the worker may be exposed to a secondary hazard (e.g., startle reaction) that should be mitigated.
3. If the analysis concludes that the current is below 0.5 mA and below 0.25 J, then the worker exposure is minimal and no special precautions are necessary, even for high-voltage circuits.

High-voltage supplies that use rated connectors and cables, when there are no exposed energized parts, are not considered hazards. Connections shall^{13.16} not be made or broken with the power supply energized, unless they are designed and rated for this type of duty (e.g., load-break elbows). Inspect cables and connectors for damage and do not use if they are damaged. Exposed high-voltage parts should be guarded to avoid accidental contact.

13.3.4 Radio-Frequency/Microwave Radiation and Fields

The DOE complex conducts R&D programs that involve sources of radio-frequency/microwave (RFMW) non-ionizing EMR. Devices that may produce RFMW radiation include: telecommunications and radar equipment; industrial equipment, such as radio-frequency heaters; and, scientific and medical equipment, such as magnetic resonance imagers and klystron tubes. The nationally-recognized consensus standard for personnel exposure to radio-frequency radiation is IEEE/ANSI C95.1.

13.3.4.1 Hazards

1. RF amplifiers frequently use DC high-voltage power sources.
2. There may be X-ray hazards (when supply voltage exceeds 10 kV and there are evacuated components). Currents may be induced in conductive objects or metal structures that are not part of the RF structure.
3. RF currents can cause severe burns.
4. Falls from towers may result from RF burns from antennas.
5. EM interference may cause equipment to malfunction.
6. EM fields may cause unintended ignition of explosives, fuel, and ordnance.
7. Grounding and bonding conductors that are adequate for DC and power frequencies may develop substantial voltage when fast pulses and radio frequency currents are present, due to inductance and skin effect.

13.3.4.2 Design and Construction

Engineering control in accordance with IEEE/ANSI C95.1 should be the primary method used to restrict exposure, whenever practical. If engineering controls are not practical, work-time limits, based on the averaging intervals and other work-practice and administrative controls, shall^{13.17} be used including:

1. Warning Signs – Signs commensurate with the RFMW level should be used to warn personnel of RFMW hazards. These signs shall^{13.18} be posted on access panels of RFMW enclosures and at entrances to and inside regulated areas.
2. Access Limitation – Access can be limited by controls, such as barriers, interlocks, administrative controls, or other means. The operation supervisor controls access to

regulated areas and shall^{13.19} approve non-routine entry of personnel into these places. When practical, sources of RFMW radiation should be switched off when not in use.

3. Shielding – Shielding that encloses the radiating equipment or provides a barrier between the equipment and the worker may be used to protect personnel. The shielding design should account for the frequency and strength of the field.
4. Interlocks – Chamber or oven-type equipment that uses microwave radiation shall^{13.20} have interlocks designed to (a) prevent generation of the radiation, unless the chamber is sealed, and (b) shut off such equipment, if the door is opened.
5. Lockout/Tagout – The design should incorporate features that allow the equipment to be locked out and tagged out for servicing.
6. PPE – PPE, such as eyewear is not readily available and is generally not a useful option as protection against RFMW radiation and fields. Protection should, therefore, be achieved by other means.

13.3.4.3 Exemptions from RFMW Exposure Limits

The following items are exempt from the RFMW exposure limits. However, their manufacture is subject to federal RFMW emission standards:

1. Cellular phones and two-way pagers and personal digital assistants;
2. Two-way, hand-held radios and walkie-talkies that broadcast between 10 kHz and 1 GHz and emit less than 7 W;
3. Microwave ovens used for heating food; and
4. Video display terminals.

13.3.4.4 Exposure Criteria for Pulsed RFMW Radiation

The basic considerations for peak-power exposure limits are consistent with ANSI/IEEE C95.1, as follows:

1. For more than five pulses in the averaging time and for pulse durations exceeding 100 milliseconds, normal time-averaging applies and the time-averaged power densities should not exceed the Maximum Permissible Exposure (MPE) found in IEEE/ANSI C95.1 (2005).
2. For intermittent pulse sources with no more than five pulses during the averaging time, the peak power density for any of the pulses should not exceed the limit given by the following equation.

$$MPE_p = \frac{MPE_a(t_a)}{5(t_p)}$$

where:

MPE_p = Peak (power density)

MPE_a = Time – Average (power density)

t_a = Averaging time (seconds)

t_p = Pulse width (seconds)

This limits the specific absorption (SA) of each pulse to SA=28.8 J/kg (whole-body or spatial average), or SA=144 J/kg for 5 pulses.

For intermittent pulse sources with no more than five pulses during the averaging time, the single-pulse SA of < 28.8 J/kg, though higher than the threshold for auditory effect (clicking), is three orders of magnitude lower than the SAs that produce RF-induced unconsciousness.

3. Maximum Electric (E) field for any of the pulses should be no more than 100 kilovolts/meter (kV/m). This peak E-field limit is prescribed to eliminate the possibility of air breakdown or spark discharges, which occur at 2,900 V/m. A large safety factor is applied to account for local field enhancements where nominally lower fields may result in arcing discharges.

13.4 METHODS

13.4.1 Wiring Methods

13.4.1.1 Hazards

Unsafe wiring methods can cause electrical injury or fire hazards.

R&D work that does not meet the requirements and may include the use of wiring methods that are not anticipated in the NEC. These methods may not be consistent with normal commercial and industrial wiring methods, and should be reviewed by the AHJ for approval.

13.4.1.2 Design and Construction

13.4.1.2.1 Design and Construction as an Integral Part of Equipment

If the AHJ determines that wiring is an integral part of an apparatus (e.g., instrumentation interconnections), the wiring methods used should be evaluated by the AHJ, to ensure they provide safe operating conditions. This evaluation may be based on a combination of standards and engineering documentation, where appropriate. Such an evaluation should consist of an analysis of all stresses imposed on any electrical conductive elements, including, but not limited to electrical, magnetic, heating, and physical damage potential. The wiring methods selected should mitigate, to the greatest practical extent, any undesired effects of a failure sequence.

If cable trays are used as mechanical support for experimental circuits, they should be solely dedicated to this use and appropriately labeled. Any such use should be analyzed for detrimental heating effects of the proposed configuration.

13.4.1.2.2 Power Supply Interface Between Utility Systems and R&D Equipment

Utility supply voltages should be brought as near to the utilization equipment as possible using NEC-compliant wiring methods.

Any temporary wiring methods used (e.g., extension cords) should be approved by the AHJ for a specified limited time.

Flexible cords and cables should be routed in a manner to minimize tripping hazards.

The conventional use of cable trays is defined in NEC Article 392. If power cables are placed in a cable tray used for control and signal cables, separation may be required. According to NEC Article 392.6(E), multiconductor cables rated at 600 V or less are permitted to be installed in the same cable tray. This presumes the cables are listed, having a minimum rating of 300 V.

However, cables rated over 600 V require separation from those rated at 600 V or less, per Article 392.6(F). Communications cables are required to be separated from light or power conductors by at least 2 inches, in accordance with NEC Article 800.133(A)(2).

Certain experimental configurations or physical constraints may need the unconventional application of cable trays. Only the AHJ may approve these unconventional applications. If deemed necessary, enhanced fire protection, or other safety measures, should be used to ensure safety to personnel and equipment.

For coaxial, helix, and specialty cables used for experimental R&D equipment, when NEC tray-rated cable types are not available that meet the technical specifications of the installation, the non-tray-rated cables may be permitted with the approval of the AHJ. If deemed necessary, enhanced fire protection, or other safety measures, should be used to ensure safety to personnel and equipment.

When a metallic cable tray is being used, it shall^{13.21} be bonded to the equipment grounding system, but may only be relied upon to provide the equipment ground if the cable tray is metallic and continuous maintenance and supervision ensure that qualified persons service the installed cable tray system. If these requirements are not met, the experimental equipment shall^{13.22} be appropriately grounded by some other approved method.

13.4.1.3 Operation and Maintenance

The operation and maintenance of R&D systems that use wiring methods that are not anticipated by the NEC dictate special considerations from all personnel. The AHJ evaluation for safe operating conditions shall^{13.17} include a review of unique features in the engineering documentation.

13.4.2 Unconventional Practices

R&D performed by DOE contractors often incorporates the design of specialized equipment resulting in the need for specialized grounding and the use of materials and components in an unconventional manner. Even with these experimental needs and special design considerations, the maximum safety of personnel and equipment still needs to be ensured. The practice of using materials or components for purposes other than originally designed needs special consideration in their use, identification, personnel protection, and equipment protection and should obtain the AHJ approval for use.

13.4.2.1 Grounding

13.4.2.1.1 Hazards

The lack of proper grounding can cause electrical shock and/or burns to personnel. The NEC defines legally-required grounding. To mitigate potential hazards, grounding shall^{13.23} be provided in accordance with the NEC and NFPA 70E.

13.4.2.1.2 Design and Construction

NEC, Article 250, *Grounding*, notes that grounds also provide:

1. Voltage limitation in case of lightning, line surges, or unintentional contact with higher voltage lines;
2. Stability of voltage to ground under normal operation; and

3. A path to conductive objects that limits the voltage to ground.

In R&D work, there is one additional function for grounds, which is a common reference plane or system ground return for electronic devices, circuits, and systems). It is recognized that such grounds are essential in some cases to control:

1. Noise associated with the primary power system (e.g., incoming on the line, or outgoing from local equipment);
2. Ground wire noise; and
3. Circuit coupling (e.g., ground loop (shared circuit return), or magnetic, capacitive, or electro-magnetic.

If system return impedances are low enough, simple RF chokes can be used to limit this noise with no effect on the safety function.

A 50-microhenry choke adds 1/50 of an ohm impedance at 60 Hz, 2 ohms impedance at 7.5 kHz and 30 ohms impedance at 100 kHz. Such an RF choke serves to discriminate against noise on the ground circuit.

An inexpensive RF choke may be installed in the safety ground by:

1. Pulling the green ground wire 20 feet longer than necessary;
2. Coiling the extra length into a 6-inch diameter coil (about 12 turns);
3. Securing it tightly wound with cable ties; and
4. Connecting it into the circuit.

These actions satisfy the NEC requirement for a continuous ground and noise isolation is also enhanced. Whatever scheme is used, the ground of experimental equipment shall^{13,24} be connected to the same ground as the facilities' electrical system to ensure equal potential.

For practices involving hazardous materials, such as explosives, the grounding shall^{13,25} also comply with the requirements of Section 6.0, *Special Occupancies*, of this Handbook.

13.4.2.1.3 Noise Coupling Mechanisms.

Grounding can reduce the interference in the five types of coupling mechanisms listed below:

1. **Conductive Coupling.** (Source and load-wired together) – It is sometimes practical to provide a separate return path for both the source and the load. If the system layout allows this, then conductive coupling cannot occur between these two, as is shown in Figures 13-1 and 13-2.
2. **Capacitive Coupling.** (High-impedance proximity coupling) – The technique for increasing resistance to capacitive coupling among cables is to ground one end of the shield to produce the shortest, most direct shunt path back to the source of the coupled current, as is shown in Fig. 13-3.

Caution: It is possible to inadvertently increase coupling between source and load, if the shield ground does not properly shunt the current coupled onto the shield.

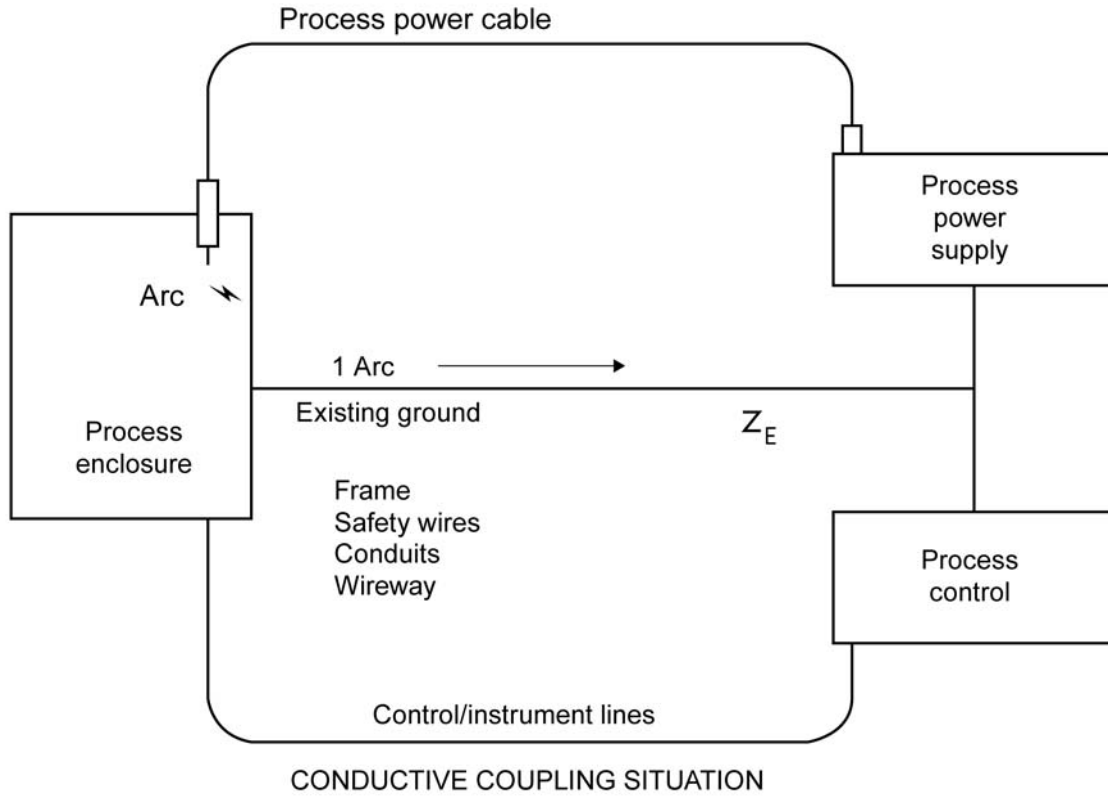

Fig. 13-1. Conductive coupling through a common ground.

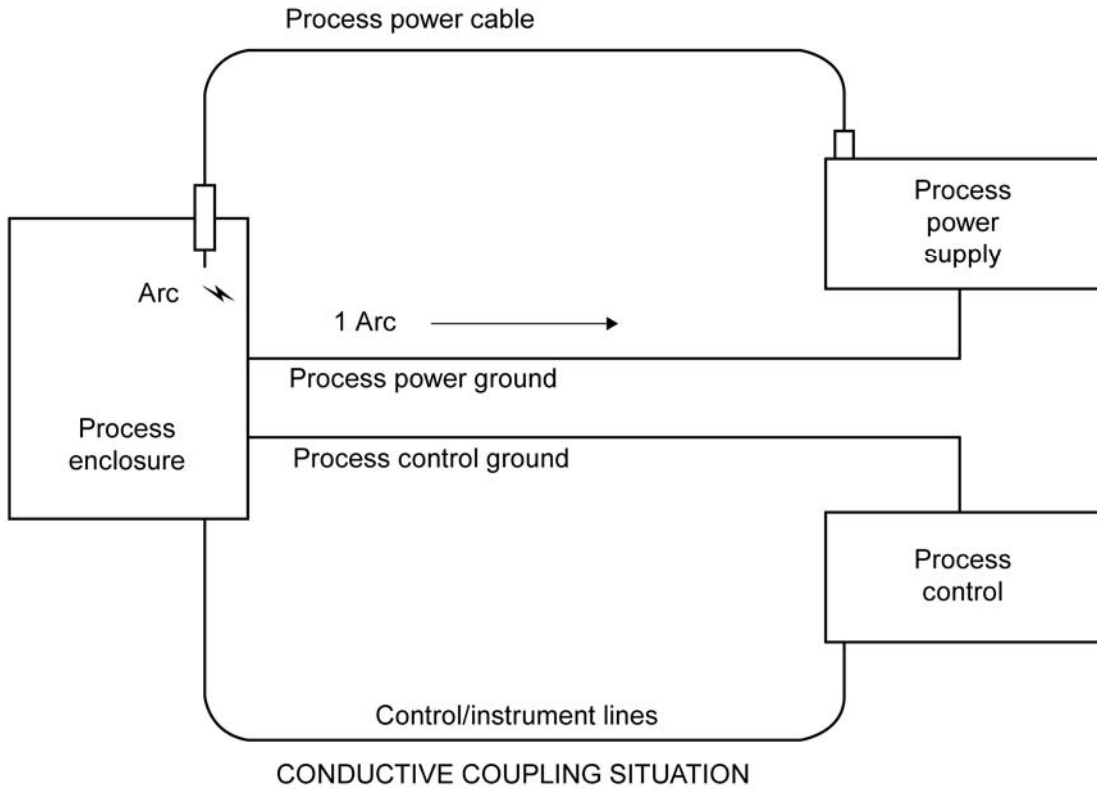

Fig. 13-2. Solution to common ground conductive coupling.

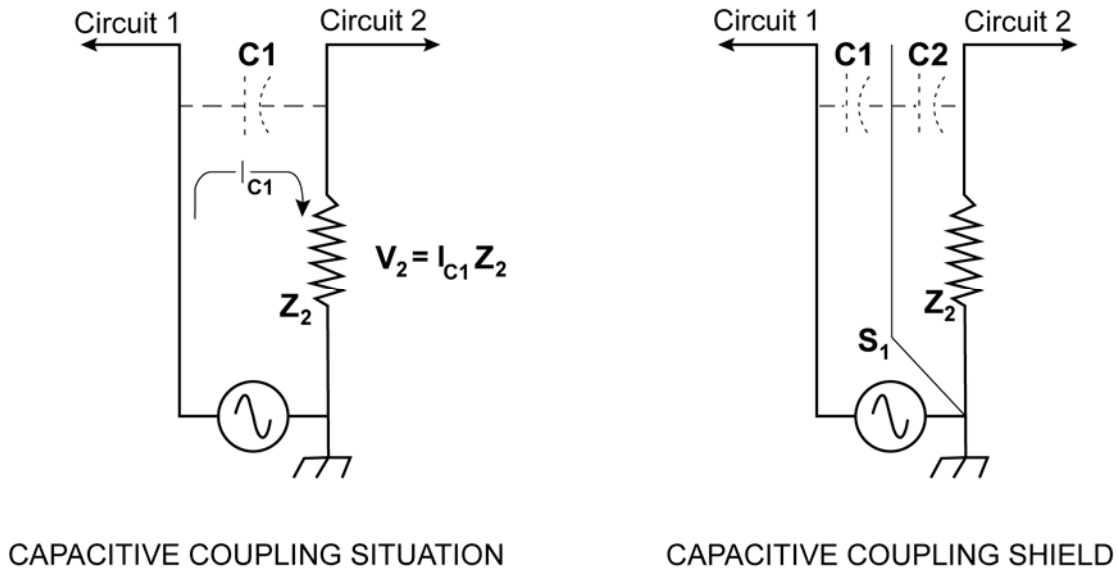
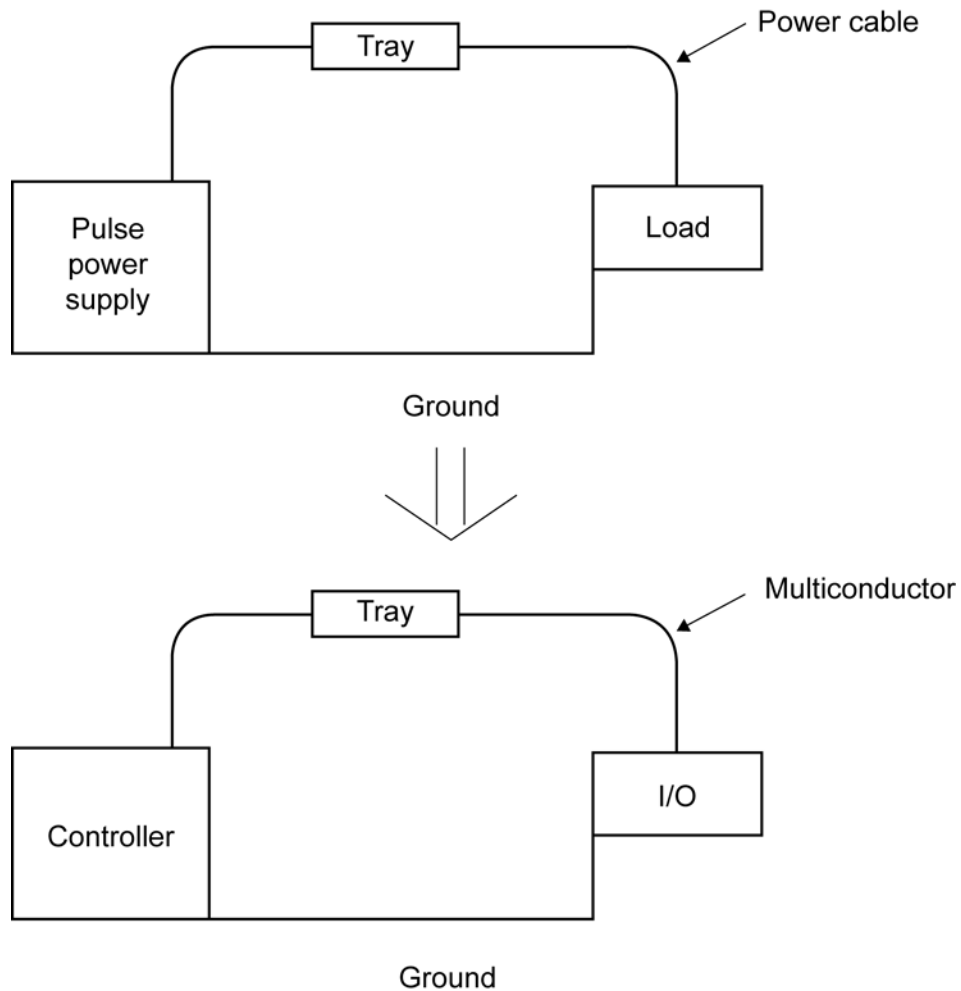

Fig. 13-3. Capacitive coupling between two circuits.

3. Inductive Coupling. (Near-field, low-impedance loop-to-loop coupling) – The technique for increasing resistance to magnetic coupling in shielded cables is to ground both ends of the shield to an effective signal return ground, as is shown in Figure 13-4.



INDUCTIVE COUPLING SITUATION

Fig. 13-4. Inductive coupling between two circuits.

4. System Signal Returns. Each installation warrants individual analysis and treatment. A single ground poses no problem, but multiple grounds can result in a ground loop. These can upset the proper functioning of instruments. A signal isolator offers a way of overcoming the problem.
5. Instrumentation Grounding¹ – Equipment that is used to implement a control instrumentation strategy (makes use of a common signal ground as a reference for analog signals. Any additional grounds that are introduced into the control circuit usually results in ground loops.

¹ Much of the information above came from the article entitled "Causes and Cures of Instrumentation Ground Loops," by Pat Power, Moore Industries, Houston, TX.

A typical process instrumentation loop is shown in Figure 13-5. It is a DC system that operates at a specific voltage (24 V in this case) to a master ground reference called a signal ground. The instrumentation signal varies within the range of 4-20 mA, depending upon the value of the variable (pressure, temperature, etc.) seen by the sensor. A precisely calibrated circuit takes this mA signal and converts it into a form that can be used by a process-control computer, a programmable logic controller, a dedicated instrument, or whatever controller that supervises the system. In this example, the mA signal is converted to a 1-5 V signal for a chart recorder. At 4 mA, the voltage measured by the recorder is $250 \times 0.004 = 1$ V. At 20 mA, the measured voltage is 5 V. Normally, the recorder scale is calibrated so the voltage reads directly in °F, psi, etc.

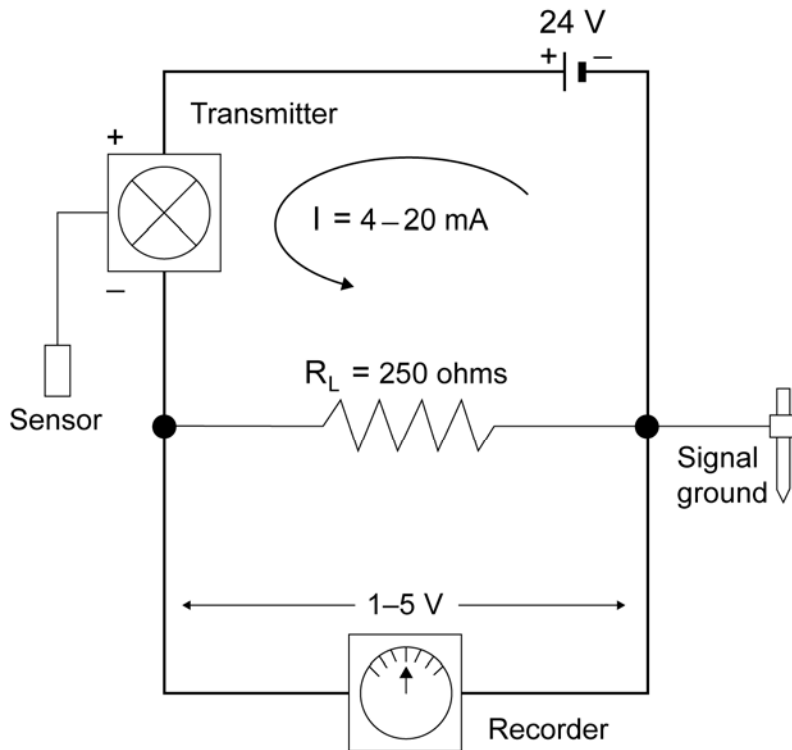

INSTRUMENTATION LOOPS

Fig. 13-5. Typical process instrumentation loop.

In order to minimize the danger of introducing ground loops into this complicated network of sensitive equipment, a dedicated instrumentation system ground bus is usually employed. This bus ultimately receives grounds from the signal common, the DC power supply common, the cabinet ground, and the instrumentation AC power ground. The bus is tied to earth via the building ground and the plant ground grid. Figure 13-6 shows the typical way in which interconnection of these various grounds is accomplished.

The cabinet ground is a safety ground that protects equipment and personnel from accidental shock hazards while providing a direct drain line for any static charges or EMI that may affect the cabinets. The cabinet ground remains separate from the DC signal ground until it terminates at the master ground bus.

Eliminating grounds is not feasible for some instruments, such as thermocouples and some analyzers, because they need a ground to obtain accurate measurements. Also, some instruments are grounded to ensure personnel safety.

When grounds cannot be eliminated, the solution to instrumentation ground loops lies in signal isolators. These devices break the galvanic path (DC continuity) between all grounds, while allowing the analog signal to continue throughout the loop. An isolator also eliminates the noise of AC continuity (common-mode voltage).

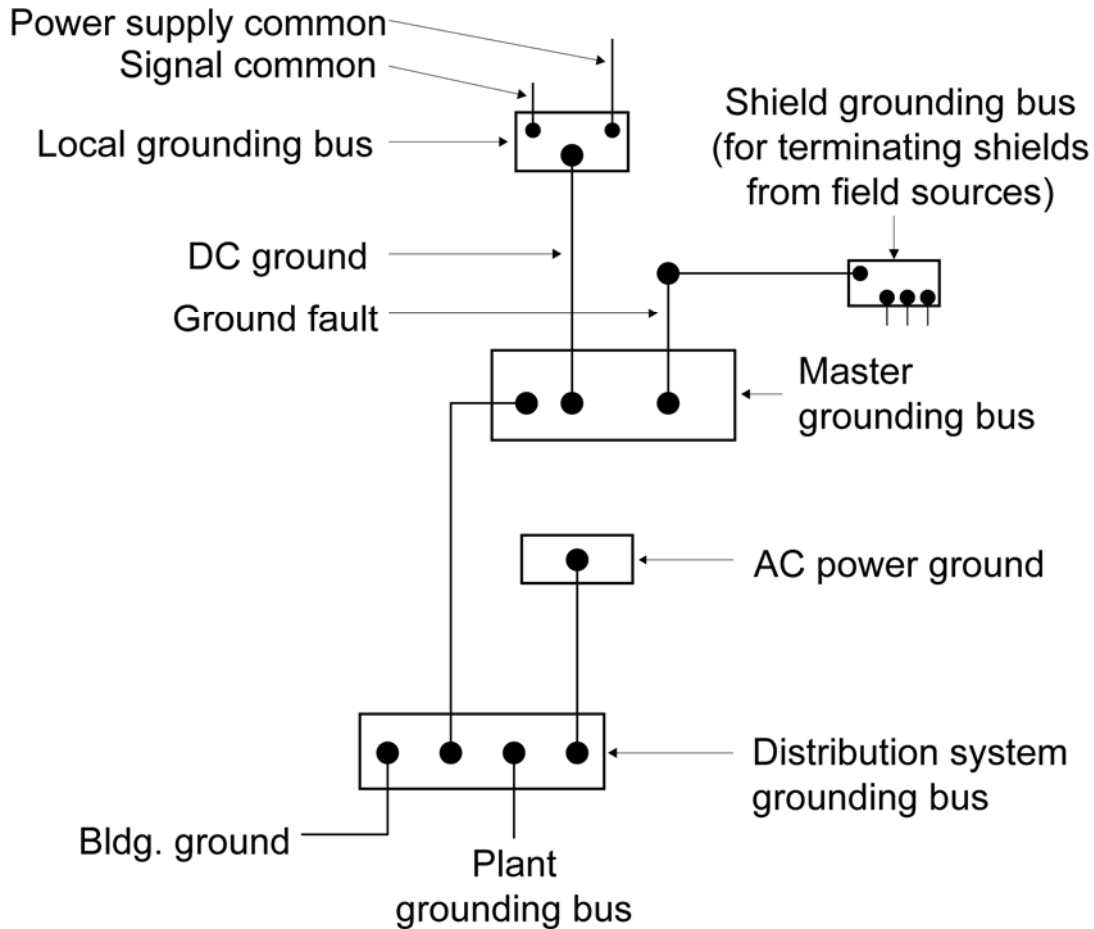

Fig. 13-6. Typical control instrumentation ground system.

13.4.2.1.4 Operation and Maintenance

Before starting each operation (experiment, test, etc.) the exposed portions of the grounding system should be visually checked for any damage and to determine that all necessary connections have been made. If more than one operation is conducted every day, visual checks should be performed only at the beginning of each shift during which the grounding system is needed. The adequacy of the grounding system should be verified annually. It is recommended that the grounding impedance within the equipment be maintained at 0.25 ohms, or less (see IEEE 1100, *IEEE Recommended Practice for Powering and Grounding Electronic Equipment*).

13.4.2.2 Materials Used in an Unconventional Manner

The practice of using materials or components for purposes other than originally designed needs special safety considerations in use, identification, personnel protection, and equipment protection.

13.4.2.2.1 Hazards

The use of materials for something other than their original design criteria has the potential for providing an additional hazard, especially to personnel unfamiliar with the research apparatus. Personnel may assume that the material is used as originally designed and can unknowingly expose themselves to hazards, unless special precautions are followed.

Some examples of items used in an unconventional manner are:

1. Copper pipe used as an electrical conductor;
2. Insulated flexible copper pipe used as an electrical conductor;
3. Specially designed high-voltage or high-current connectors;
4. Specially designed high-voltage or high-current switches;
5. Water column used as a high-voltage resistor;
6. Standard coaxial cable used in special high-voltage pulsed circuits;
7. Water column used as a charged-particle beam attenuator; and
8. Commercial cable tray used as a mechanical support for experimental apparatus.

13.4.2.2.2 Design and Construction

During design, special consideration should be given to installing interlocks and protective barriers. Signs warning of the hazards should be posted to help prevent unsuspecting personnel from being injured.

13.4.2.2.3 Operation and Maintenance

Appropriate safety procedures and training shall^{13.26} be part of the process to qualify personnel. The procedures shall^{13.27} describe the methods used to promote safe work practices relating to work on energized circuits in accordance with Section 2.1.2, *Considerations for Working on Energized Systems and Equipment*, Section 2.12, *Work Practices*, and 29 CFR 1910.331-335.

13.4.3 Work on Energized or De-Energized Electrical Equipment

Unless explicitly stated otherwise in this section, all work on energized/de-energized equipment is expected to conform to Section 2.0, *General Requirements*.

13.5 REQUIREMENTS FOR SPECIFIC R&D EQUIPMENT

Electrical equipment and components used in research may pose hazards not commonly found in industrial or commercial facilities. Special precautions are necessary to design, operate, repair, and maintain such equipment. Electrical safety and personnel safety circuits (e.g., interlocks) are covered in this section as a guide to reduce or eliminate associated hazards. Training and experience in the specialized equipment are necessary to maintain a safe workplace.

All personnel involved with research electrical equipment should be trained and be familiar with the hazards they may encounter in the workplace. Only qualified electrical personnel should design, install, repair, or maintain electrical research equipment or components. Safety-related design, operation, and maintenance techniques should be incorporated into all new or modified equipment. Existing equipment should be modified, when necessary, to ensure safety. Equipment for which specific standards are not available should be constructed according to the principles of established standards, and approved by the AHJ.

Capacitors and inductors are used in research apparatus in special configurations, as well as in their standard configurations. The design, operation, and maintenance of research apparatus using capacitors and inductors in these special configurations dictate that special consideration be given to the safety of both personnel and equipment.

13.5.1 Capacitors

This section covers capacitors that are used in the following typical R&D applications:

1. Energy storage;
2. Voltage multipliers;
3. Filters; and
4. Isolators.

13.5.1.1 Hazards

Examples of capacitor hazards include:

1. Capacitors may store and accumulate a dangerous residual charge after the equipment has been de-energized. Grounding capacitors in series may transfer rather than discharge the stored energy.
2. A hazard exists when a capacitor is subjected to high currents that may cause heating and explosion.
3. When capacitors are used to store large amounts of energy, internal failure of one capacitor in a bank frequently results in explosion when all other capacitors in the bank discharge into the fault. Approximately 10^4 J is the threshold energy for explosive failure of metal cans.
4. High-voltage cables should be treated as capacitors, since they have the capability to store energy.
5. The liquid dielectric and combustion products of liquid dielectric in capacitors may be toxic.
6. Because of the phenomenon of "dielectric absorption," not all the charge in a capacitor is dissipated when it is short-circuited for a short time.
7. A dangerously high-voltage can exist across the impedance of a few feet of grounding cable at the moment of contact with a charged capacitor.
8. Discharging a capacitor by means of a grounding hook can cause an electric arc at the point of contact (see 13.5.1.2.3).
9. Internal faults may rupture capacitor containers. Rupture of a capacitor can create a fire hazard. Dielectric fluids may release toxic gases when decomposed by fire or the heat of an electric arc.

10. Fuses are generally used to preclude the discharge of energy from a capacitor bank into a faulted individual capacitor. Improperly sized fuses for this application may explode.

13.5.1.2 Design and Construction

The following cautions in design and construction need to be considered:

1. Isolate capacitor banks by elevation, barriers, or enclosures to preclude accidental contact with charged terminals, conductors, cases, or support structures.
2. Interlock the circuit breakers or switches used to connect power to capacitors.
3. Provide capacitors with current-limiting devices.
4. Design safety devices to withstand the mechanical forces caused by the large currents.
5. Provide bleeder resistors on all capacitors not having discharge devices.
6. Design the discharge-time-constant of current-limited shorting and grounding devices to be as small as practicable.
7. Provide suitable grounding.

13.5.1.2.1 Automatic Discharge Devices

The following need to be considered:

1. Use permanently connected bleeder resistors when practical.
2. Have separate bleeders when capacitors are in series.
3. Automatic shorting devices that operate when the equipment is de-energized, or when the enclosure is opened, shall^{13.28} be employed, which discharges the capacitor to safe voltage (50 V or less) in less time than is needed for personnel to gain access to the voltage terminals. It shall^{13.29} never be longer than 1 minute.
4. For equipment with stored energy greater than 10 J, provide an automatic, mechanical discharging device that functions when normal access ports are opened
5. Ensure that discharge devices are contained locally within protective barriers to ensure wiring integrity. They should be in plain view of the person entering the protective barrier so that the individual can verify proper functioning of the devices.
6. Provide protection against the hazard of the discharge itself.

13.5.1.2.2 Safety Grounding

The following need to be considered:

1. Fully visible, manual grounding devices shall^{13.30} be provided to render capacitors safe while work is being performed.
2. Grounding points shall^{13.31} be clearly marked.
3. Prevent transferring charges to other capacitors.

13.5.1.2.3 Ground Hooks

The following need to be considered:

1. Conductor terminations should be soldered or terminated in an approved crimped lug. All conductor terminations should be strain-relieved within 15 cm.

2. The impedance from the tip of the ground hook to ground should be less than 0.1 ohm.
3. The cable conductor should be clearly visible through its insulation.
4. A cable conductor size of at least #2 AWG should be used, with the conductor sized to be capable of carrying the available fault current of the system.
5. A sufficient number of ground hooks should be used to adequately ground all designated points.
6. If they are permanently installed, ground hooks should be permanently grounded and stored in a manner to ensure that they are used.

13.5.1.2.4 Discharge Equipment with Stored Energy in Excess of 5 Joules

The following need to be considered:

1. A discharge point with an impedance capable of limiting the current to 500A or less should be provided.
2. The discharge point should be identified with a unique marker (e.g., yellow circular marker with a red slash), and should be labeled "HI Z PT" in large, legible letters.
3. A properly installed grounding hook should first be connected to the current-limiting discharge point, and then to a low-impedance discharge point (< 0.1 ohm) that is identified by a unique marker (e.g., yellow circular marker).
4. The grounding hooks should be left on all of these low-impedance points during the time of safe access.
5. The low-impedance points should be provided, whether or not the HI-Z current-limiting points are needed.
6. Voltage indicators that are visible from all normal entry points should be provided.

13.5.1.2.5 Fusing

The following need to be considered:

1. Capacitors connected in parallel should be individually fused, when possible.
2. Caution should be used in the placement of automatic discharge safety devices with respect to fuses. If the discharge flows through the fuses, a prominent warning sign should be placed at each entry indicating that each capacitor should be manually grounded before work can begin.
3. Special knowledge is necessary for high-voltage and high-energy fusing.

13.5.1.3 Operation and Maintenance

The following need to be considered:

1. Proper procedures need to be followed when bypassing interlocks.
2. Only qualified electrical personnel (those trained in the proper handling and storage of power capacitors and hazard recognition) shall^{13.32} be assigned the task of servicing/installing such units.
3. Proper PPE shall^{13.33} be used when working with capacitors.

4. Access to capacitor areas shall^{13.34} be restricted until all capacitors have been discharged, shorted, and grounded.
5. Any residual charge from capacitors shall^{13.30} be removed by grounding the terminals before servicing or removal.
6. Automatic discharge and grounding devices should not be relied upon.
7. Grounding hooks shall^{13.35} be inspected before each use.
8. Capacitor cases should be considered "charged."
9. Protective devices should be tested periodically.
10. All uninstalled capacitors capable of storing 5 J or greater should be short-circuited with a conductor no smaller than #14 AWG.
11. A capacitor that develops an internal open circuit may retain substantial charge internally even though the terminals are short-circuited. Such a capacitor can be hazardous to transport, because the damaged internal wiring may reconnect and discharge the capacitor through the short-circuiting wires. Any capacitor that shows a significant change in capacitance after a fault may have this problem. Action should be taken to minimize this hazard when it is discovered.

13.5.2 Inductors

This section covers inductors as well as electromagnets and coils that are used in the following typical applications:

1. Energy storage;
2. Inductors used as impedance devices in a pulsed system with capacitors;
3. Electromagnets and coils that produce magnetic fields to guide or confine charged particles;
4. Inductors used in DC power supplies; and
5. Nuclear Magnetic Resonance, Electron Paramagnetic Resonance, and Magnetic Susceptibility Systems.

13.5.2.1 Hazards

Examples of inductor hazards include:

1. Overheating due to overloads, insufficient cooling, or failure of the cooling system could cause damage to the inductor and possible rupture of the cooling system.
2. Electromagnets and superconductive magnets may produce large external force fields that may affect the proper operation of the protective instrumentation and controls.
3. Magnetic fields could attract nearby magnetic material, including tools and surgical implants, causing injury or damage by impact.
4. Whenever a magnet is suddenly de-energized, production of large eddy currents in adjacent conductive material can cause excessive heating and hazardous voltages. This state may cause the release or ejection of magnetic objects.
5. The worker should be cognizant of potential health hazards.

6. Interruption of current in a magnet can cause uncontrolled release of stored energy. Engineered safety systems may be necessary to safely dissipate stored energy. Large amounts of stored energy can be released in the event of a "quench" in a superconducting magnet.

13.5.2.2 Design and Construction

The following need to be considered:

1. Provide sensing devices (temperature, coolant-flow) that are interlocked with the power source.
2. Fabricate protective enclosures from materials not adversely affected by external EM fields. Researchers should consider building a nonferrous barrier designed to prevent accidental attraction of iron objects and prevent damage to the cryostat. This is especially important for superconducting magnet systems.
3. Provide equipment supports and bracing adequate to withstand the forces generated during fault conditions.
4. Appropriately ground electrical supply circuits and magnetic cores and provide adequate fault protection.
5. Provide means for safely dissipating stored energy when excitation is interrupted or a fault occurs.
6. Provide appropriate warning signs to prevent persons with pacemakers or similar devices from entering areas with fields of greater than 0.001 Tesla.
7. Personnel exposure to magnetic fields of greater than 0.1 Tesla should be restricted.
8. When a magnet circuit includes switching devices that may not be able to interrupt the magnet current and safely dissipate the stored energy, provide a dump resistor connected directly across the magnet terminals that is sized to limit the voltage to a safe level during the discharge and safely dissipate the stored energy.

13.5.3 Electrical Conductors and Connectors

The conductors and connectors covered in this section are only those used in unconventional applications.

13.5.3.1 Hazards

Examples of hazards include:

1. Metallic cooling-water pipes that are also used as electrical conductors present shock hazards (i.e., they may not be readily recognizable as electrical conductors);
2. Improper application or installation of connectors can result in overheating, arcing, and shock hazards;
3. Hazardous induced voltages and arcing can result from inadequate separation between high- and low-voltage cables; and
4. Use of an improper cable for a given type of installation (routing) can result in a fire hazard.

13.5.3.2 Design and Construction

When working with special conductors and connectors for R&D applications, the following guidelines need to be implemented for design and construction:

1. Select cables that are listed by an NRTL for a given type of installation (such as in conduits, trays, underground, or in an enclosure) whenever possible. Since cables used for R&D are sometimes unique (such as some coaxial cables), they may not be available as NRTL-listed. In that case, obtain AHJ approval.
2. When liquid- or gas-cooled conductors are used, sensing devices (temperature or coolant-flow) should be provided for alarm purposes or equipment shutdown if the cooling system malfunctions.
3. Provide adequate labeling, insulation, or other protection for metallic cooling-water piping used as electrical conductors.
4. Provide engineering calculations to support overrating of conductors for any application.
5. Avoid conductor loops (wide spacing) between high-current supply and return conductors to prevent voltage and current induction in adjacent circuits or structural members.
6. Ground coaxial cable shielding when possible. If test conditions warrant an ungrounded shield, barriers and warning signs should be provided to notify personnel that the shield is ungrounded and should be assumed to be energized.
7. Provide suitable routing and additional protection for coaxial cables used in pulsed-power applications when the braid of the coaxial cable rises to high voltage levels.

13.5.3.3 Operation and Maintenance

Cable connectors and connections should be checked after installation, periodically, and should be tightened as necessary. Special attention should be given to aluminum cable connections.

Ensure that charges are not built up on equipment that has been disconnected, such as vacuum feed through systems.

13.5.4 Induction and Dielectric Heating Equipment

This section describes electrical hazards associated with induction heating, RF equipment, and microwave equipment used in research. The hazards are mainly associated with high-power/high-frequency RF generators, waveguides and conductors, and the working coils producing high temperatures.

13.5.4.1 Hazards

The following need to be considered:

1. RF power as high as 50 kW and frequency in the tens of kHz range to hundreds of MHz is supplied from the RF and microwave generators. Being close to or making contact with, an unprotected coil, conductors or waveguide opening may result in severe body burns.
2. Dangerous voltages are present inside the power generators.
3. Dangerous levels of RF energy may be present in the laboratory.

13.5.4.2 Design and Construction

The following need to be considered:

1. The heating coils, sources of high-frequency energy, and other energized parts outside the generator cabinet should be shielded or guarded to prevent access or contact.
2. The heating coil should have its cold (outside) lead properly grounded.
3. A coaxial cable of correct impedance and adequate construction may be desirable to deliver the RF power to the coil in order to prevent the leakage of the RF energy in the laboratory.

13.5.4.3 Operation and Maintenance

The following need to be considered:

1. Shielding is necessary to minimize RFMW radiation.
2. Wearing metallic objects when operating or maintaining the induction heating system should be prohibited.
3. Post suitable warnings to indicate equipment hazards.

13.5.5 Batteries

Batteries are used in multiple applications. Specialized types exist that are suitable for different applications.

Lead-acid storage battery types are the lead-antimony and the lead-calcium. The lead-antimony battery is low cost, high efficiency, small size and long life. Typically, the lead-calcium is chosen for use in UPS systems due to the similar characteristics of lead-antimony coupled with lower maintenance requirements. Both types use dilute sulfuric acid as the electrolyte.

Alkali storage battery types are the nickel cadmium and the nickel metal hydride. These batteries use compounds of nickel peroxide and iron oxide for the plate materials, and potassium hydroxide as the electrolyte. Storage batteries of this type perform well in extremes of temperature.

13.5.5.1 Other Batteries

Specialized batteries for applications include silver zinc, silver cadmium and mercury. Manufacturers' data sheets provide guidelines for safety for these and other battery types.

13.5.5.2 Hazards

13.5.5.2.1 Chemical Hazards

For each battery type considered for use, obtain Material Safety Data Sheet (MSDS) information and understand the specific hazards involved before use.

Chemicals associated with battery systems may include:

1. Cadmium (Cd);
2. Lead (Pb);
3. Lead peroxide (PbO₂);

4. Lithium hydroxide (LiOH);
5. Potassium hydroxide (KOH);
6. Sodium bicarbonate (NaHCO₃);
7. Sodium hydroxide (NaOH); and
8. Sulfuric acid (H₂SO₄).

Many of these chemicals (and other battery components not listed here) are corrosive, poisonous and/or flammable. Possible consequences of a ruptured container or spilled electrolyte include:

1. Fire;
2. Explosion;
3. Chemical burns; and
4. Reactions to toxic fumes, solids or liquids.

13.5.5.2.2 Electrical Hazards

Electrical safety during battery operations is primarily concerned with prevention of a direct short circuit across one or more cells. Due to the large amount of stored energy in the battery cells, along with the low internal resistance of the cells, a short circuit could have catastrophic results including an explosion of the cells involved. Suitable clothing has been discussed above. Personnel conducting electrical work on battery systems are to follow the following guidelines:

1. Tools shall^{13.36} be insulated. Vinyl electrical tape may not be used as an insulator because the tool does not meet the design and construction requirements.
2. Only instruments having a non-conductive case (e.g., the yellow rubber holster provided with some multimeters) are permitted in the vicinity of battery systems.
3. Storage battery systems may present terminal voltages of 48, 125 or 250 V DC. If the physical construction of the battery system permits, inter-cell or inter-tier cables should be disconnected when performing work on the battery system.
4. If one terminal of the battery system is bonded to ground, an additional hazard exists. Single-point contact between an exposed battery terminal and surrounding structures could result in very large short-circuit currents and possibly lead to fires or personal injury.

13.5.5.2.3 Physical / Mechanical Hazards

Individual cell containers:

1. May weigh in excess of 70 lbs;
2. Are not typically provided with handles; and
3. May be slippery and difficult to hold, especially when wearing gloves.

Removal and replacement of these containers necessitates work in positions which are:

1. Awkward;
2. Uncomfortable; and

3. Possibly unstable

Possible consequences include:

1. Muscle strains, falls, or dropped containers; and
2. Dropped containers which rupture and spill electrolyte.

13.5.5.3 Design and Construction

The following need to be considered:

1. Battery systems should be isolated by elevation, barriers, or enclosures to preclude accidental contact with energized terminals, conductors, cases, or support structures.
2. Battery systems should be provided with overcurrent protection devices.
3. A means of partitioning or 'sectionalizing' battery systems should be provided to allow multiple or single batteries to be disconnected (see to Figure 13-7).
4. Safety devices should be designed to withstand the mechanical forces caused by the large currents.
5. Suitable grounding should be provided.
6. Provisions should be made to contain possible spills of electrolyte.

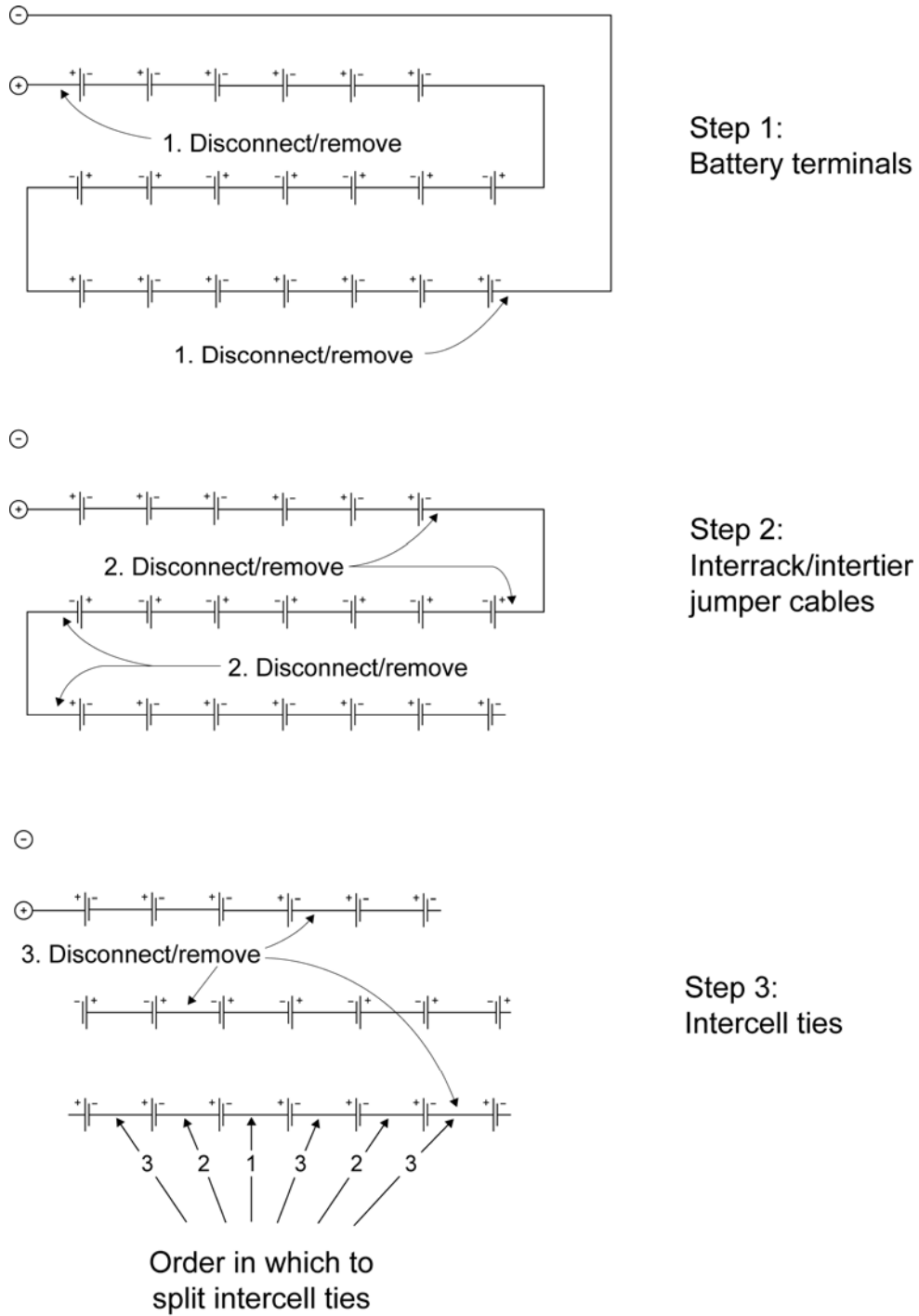

Note: The idea behind splitting the intercell ties in this manner is to reduce the exposed voltage to the fewest number of steps, thereby minimizing contact with energized parts.

Figure 13-7. Example of sectionalizing a large, multi-tier battery system.

13.5.5.4 Operation and Maintenance

Workers should handle the equipment carefully. The battery manufacturer's installation, operating and maintenance instructions give guidance about appropriate handling. Personnel attempting physical movement of battery containers should plan their work accordingly.

Safety during electrolyte-handling operations (measurement of cell specific gravities, addition of distilled water, addition or removal of electrolyte) requires the use of certain PPE and other materials. The following protective equipment shall^{13.37} be available to personnel performing battery maintenance tasks:

1. Face shield and chemical splash goggles;
2. Acid-tolerant gloves and apron, and shoe covers if the work warrants;
3. Emergency shower/eye wash equipment capable of delivering 450 gallons of water within a 15-minute interval;
4. Sodium bicarbonate solution (neutralizing agent for cleaning cell containers and neutralizing acid spills);
5. Class C fire extinguisher; and
6. Adequately insulated tools of appropriate-length.

If the cell container is tipped over, electrolyte may spill from the flash arrestor assembly. The flow of electrolyte may not be rapid, but is still a safety hazard. When lifting or moving electrolyte-filled containers, ensure they always remain in an upright position.

In the event of an electrolyte spill:

1. Minimize contact with the electrolyte by leaving the spill area.
2. Rinse contaminated protective equipment with water and sodium bicarbonate.
3. Remove contaminated clothing.
4. In case of skin contact, immediately flush with water followed by washing with soap and water.
5. Do not attempt to neutralize with sodium bicarbonate any acid spilled on the skin.
6. In case of eye contact, flush eyes for a minimum of 15 minutes, then provide transport for the individual to medical facilities. This is to be done regardless of the apparent severity of the injury.
7. Electrolyte-contaminated material or equipment is considered hazardous material and is to be treated and disposed of as such in accordance with current guidance.

Appropriate gloves and other PPE shall^{13.38} be worn to minimize the hazard due to toxic material exposure. Workers should wash their hands with soap and water after completion of the work. Eating or drinking in the vicinity of the battery system should not be permitted.

13.5.6 Lasers and X-Ray Equipment

This subsection is applicable to laser systems and X-ray equipment used in research. Both fixed and portable equipment are covered regardless of input voltage. Only electrical hazards are addressed in this subsection. Refer to ANSI Z136.1, *Safe Use of Lasers*, for laser hazards and 29 CFR 1910.306 (f) for X-ray hazards.

13.5.6.1 Hazards

1. Dangerous voltages are present inside the equipment.
2. Implosion hazards may exist with the covers removed.
3. Energy storage devices may present a hazard due to a residual charge even when the system is de-energized.
4. Dangerous voltages can exist across the impedance of the grounding conductor during operation.
5. Failure of interlocks and safety devices may allow access to energized parts.

14.0 REFERENCES

American National Standards Institute

ANSI C39.1-1981(R1992)	<i>Requirements for Electric Analog Indicating Instruments</i>
ANSI C50.13-1989	<i>Rotating Electrical Machinery</i>
ANSI Z41-1991	<i>Personal Protection-Protective Footwear</i>
ANSI Z87.1-1979	<i>Practice for Protection Occupational and Educational Eye and Face Protection</i>
ANSI Z89.1-1986	<i>Protective Headwear for Industrial Workers-Requirements</i>
ANSI/LIA Z136.1-1993	<i>Safe Use of Lasers</i>
ANSI/ISA/UL-61010-1	<i>Safety Requirements for Electrical Equipment for Measurement, Control, and Laboratory Use</i>

American Society of Mechanical Engineers

ASME A17.1	<i>Safety Code for Elevators and Escalators, 1984</i>
ASME A17.2.1	<i>Inspectors Manual for Electric Elevators, 1993</i>
ASME A17.2.2	<i>Inspectors Manual for Hydraulic Elevators, 1994</i>
ASME A17.2.3	<i>Inspectors Manual for Escalators and Moving Walks, 1994</i>
ASME A17.3	<i>Safety Code for Existing Elevators and Escalators, 1986</i>
ASME B30.2	<i>Overhead and Gantry Cranes, 2001</i>
ASME B30.11	<i>Systems and Underhung Cranes, 1998</i>
ASME B30.16	<i>Overhead Hoists (Underhung), 1998</i>

American Society for Testing and Materials

ANSI/ASTM D120-1987	<i>Specifications for Rubber Insulating Gloves</i>
ASTM D178-1988	<i>Specifications for Rubber Insulating Matting</i>
ASTM D1048-99	<i>Specification for Rubber Insulating Blankets</i>
ASTM D1049-98	<i>Standard Specification for Rubber Insulating Covers</i>
ASTM D1050-99	<i>Standard Specification for Rubber Insulating Line Hoses</i>
ASTM D1051-02	<i>Standard Specification for Rubber Insulating Sleeves</i>
ASTM F478-02	<i>Standard Specification for In-Service Care of Insulating Line Hose and Covers</i>
ASTM F496-02a	<i>Standard Specification for the In-Service Care of Insulating Gloves and Sleeves</i>
ASTM F696-02	<i>Standard Specification for Leather Protectors for Rubber Insulating Gloves and Mittens</i>
ASTM F711-02	<i>Standard Specification for Fiberglass-Reinforced Plastic (FRP) Rod and Tube Used in Live Line Tools</i>

DOE-HDBK-1092-2013

ASTM F855-09	<i>Standard Specification for Temporary Protective Grounds to be Used on De-energized Electric Power Lines and Equipment</i>
ASTM F887-04	<i>Standard Specification for Personal Climbing Equipment</i>
ASTM F1116-03	<i>Standard Test Method for Determining Dielectric Strength of Overshoe Footwear</i>
ASTM F1117-03	<i>Standard Specification for Dielectric Overshoe Footwear</i>
ASTM F1505-01	<i>Specification for Insulated and Insulating Hand Tools</i>
ASTMF1506-02ae1	<i>Standard Performance Specification for Flame Retardant Textile Materials for Wearing Apparel for Use by Electrical Workers Exposed to Momentary Electric Arc and Related Thermal Hazards</i>
ASTM F1742-03	<i>Standard Specification for PVC Insulating Sheeting</i>
ASTM F1958	<i>Standard Test Method for Determining the Ignitability of Non-Flame-Resistant Materials or Clothing by Electric Arc Exposure Using Mannequins</i>
ASTM F1959	<i>Standard Method for Determining the Arc Rating of Materials for Clothing</i>
ASTM F2412	<i>Standard Test Methods for Foot Protection</i>
ASTM F 1957	<i>Test Method for Determining the Ignitability of Clothing by the Electrical Arc Exposure Method Using a Mannequin</i>
ASTM F 1958	<i>Test Method for Determining the Arc Thermal Performance (Value) of Textile Materials for Clothing by Electric Arc Exposure Method Using Instrumented Sensor Panels</i>

Crane Manufacturers Association of America

CMAA-70	<i>Specifications for Top Running Bridge and Gantry Type Multiple Girder Electric Overhead Traveling Cranes</i>
CMAA-74	<i>Specifications for Top Running and Under Running Single Girder Electric Overhead Traveling Cranes</i>
<i>CMAA Crane Operators' Manual</i>	
<i>CMAA Overhead Crane Inspection and Maintenance Checklist</i>	

Department of Energy Orders, Manuals, and Guides

DOE O 433.1	<i>Maintenance Management Program for DOE Nuclear Facilities, 2001</i>
DOE O 4330.4B	<i>Management Program, 1994 (Archived)</i>
DOE O 440.1A	<i>Worker Protection Management for DOE Federal and Contractor Employees, 1998</i>
DOE M 440.1-1	<i>DOE Explosives Safety Manual, 1995</i>

Department of Defense Standards

DOD 6055.9-STD	<i>DoD Ammunition and Explosives Safety Standards, Department of Defense, 1986</i>
DOD FIPS-PUB-94	<i>Guidelines on Electrical Power for ADP Installations</i>
DOD MIL-HDBK-419A (Volumes 1 and 2)	<i>Grounding, Bonding, and Shielding for Electronic Equipment and Facilities (Basic Theory, Applications)</i>

Department of Labor-OSHA

29 CFR 1910	<i>Occupational Safety and Health Standards</i>
29 CFR 1926	<i>Safety and Health Regulations for Construction</i>
30 CFR 57	<i>Safety and Health Standards-Underground Metal and Nonmetal Mines</i>
30 CFR 75	<i>Mandatory Safety Standards-Underground Coal Mines</i>
30 CFR 77	<i>Mandatory Safety Standards, Surface Coal Mines and Surface Work Areas of Underground Coal Mines</i>
10 CFR 851	<i>Worker Safety and Health Program</i>

Institute of Electrical and Electronic Engineers

IEEE 80-2000	<i>Guide for Safety in AC Substation Grounding, 1986</i>
IEEE 141-1993	<i>IEEE Recommended Practice for Electric Power Distribution for Industrial Plants, (IEEE Red Book)</i>
IEEE 142-1991	<i>IEEE Recommended Practice for Grounding of Industrial and Commercial Power Systems, (IEEE Green Book)</i>
IEEE 484-1996	<i>IEEE Recommended Practice for Installation Design and Installation of Vented Lead-Acid Batteries for Stationary Applications</i>
IEEE 450-1995	<i>IEEE Recommended Practice for Maintenance, Testing, and Replacement of Vented Large Lead-Acid Batteries for Stationary Applications</i>
IEEE 516-2003	<i>IEEE Guide for Maintenance Methods on Energized Power-Lines</i>
IEEE 524-2003	<i>IEEE Guide to the Installation of Overhead Transmission Line Conductors</i>
IEEE 524A-1998	<i>IEEE Guide to Grounding During the Installation of Overhead Transmission Line Conductors</i>
IEEE 835-1994	<i>IEEE Standard Power Cable Ampacity Tables</i>
IEEE 848-1996	<i>IEEE Standard Procedure for the Determination of the Ampacity Derating of Fire Protected Cables</i>
IEEE 978-1984	<i>IEEE Guides for In-Service Maintenance and Electrical Testing of Live-Line Tools</i>
IEEE 1048-2003	<i>IEEE Guide for Protective Grounding of Power Lines</i>

DOE-HDBK-1092-2013

IEEE 1100-1999	<i>IEEE Recommended Practice for Powering and Grounding Electronic Equipment</i>
IEEE/ANSI C-2	<i>National Electrical Safety Code, 2002</i>
IEEE C62.11-1987	<i>IEEE Standard for Metal-Oxide Surge Arrestors for AC Power Circuits</i>
IEEE/ANSI C95.1 (1999)	<i>Standard for Safety Levels With Respect to Human Exposure to Radio Frequency Electromagnetic Fields, 3KHz to 3000GHz</i>

Instrument Society of America

ANSI/ISA-RP12.06.01-2003	<i>Wiring Practices for Hazardous (Classified) Locations, Instrumentation Part 1: Intrinsic Safety</i>
ANSI/ISA-S82.01-1994	<i>Safety Standard for Electrical and Electronic Test, Measuring, Controlling, and Related Equipment - General Requirements</i>
ANSI/ISA-S82.02-1988	<i>Safety Standard for Electrical and Electronic Test, Measuring, Controlling, and Related Equipment: Electrical and Electronic Test and Measuring Equipment, (Partial Revision and Redesignation of ANSI C39.5-1974)</i>
ANSI/ISA-S82.03-1988	<i>Safety Standard for Electrical and Electronic Test, Measuring, Controlling, and Related Equipment: Electrical and Electronic Process Measurement and Control Equipment, (Partial Revision and Redesignation of ANSI C39.5-1974)</i>

National Electrical Manufacturers Association

NEMA 250-1997	<i>Enclosures for Electrical Equipment (1000 Volt Maximum)</i>
NEMA MG1	<i>Motors and Generators, 2003</i>
NEMA PB2.2	<i>Application Guide for Ground Fault Protection Devices for Equipment, 2004</i>

National Fire Protection Association

NFPA Handbook	<i>Electrical Installations in Hazardous Locations, by P.J. Schram and M.W. Earley, 2003</i>
NFPA 70	<i>National Electrical Code, 2008</i>
NFPA 70B	<i>Recommended Practice for Electrical Equipment Maintenance, 2002</i>
NFPA 70E	<i>Standard for Electrical Safety in the Workplace, 2009</i>
NFPA 72	<i>National Fire Alarm Code, 2002</i>
NFPA 77	<i>Recommended Practice on Static Electricity, 2000</i>
NFPA 79	<i>Electrical Standard for Industrial Machinery, 2007</i>
NFPA 101	<i>Life Safety Code, 1997</i>
NFPA 325	<i>Fire Hazard Properties of Flammable Liquids, Gases, and Volatile Solids, 1994</i>

DOE-HDBK-1092-2013

NFPA 496	<i>Standard for Purged and Pressurized Enclosures for Electrical Equipment, 2003</i>
NFPA 497M	<i>Classification of Gases, Vapors, and Dusts for Electrical Equipment in Hazardous (Classified) Locations, 1991</i>
NFPA 780	<i>Standard for the Installation of Lighting Protection Systems, 1997</i>

Underwriters Laboratory

UL 745 Series	<i>UL Standard for Safety for Portable Electric Tools, May 2012</i>
UL 508	<i>UL Standard for Safety for Industrial Control Equipment, 2003</i>
UL 698	<i>UL Standard for Safety for Industrial Control Equipment for Use in Hazardous (Classified) Locations, 1999</i>
UL 877	<i>UL Standard for Safety for Circuit Breakers and Circuit-Breaker Enclosures for Use in Hazardous (Classified) Locations, 1999</i>
UL 886	<i>UL Standard for Safety for Outlet Boxes and Fittings for Use in Hazardous (Classified) Locations, 1999</i>
UL 894	<i>UL Standard for Safety for Switches for Use in Hazardous (Classified) Locations, 1999</i>
UL 913	<i>Intrinsically Safe Apparatus and Associated Apparatus for Use in Class I, II, and III, Division I, Hazardous (Classified) Locations, 2004</i>
UL 1244	<i>Electrical and Electronic Measuring and Testing Equipment, 2000</i>
UL 1097	<i>Double Insulation Systems for Use in Electric Equipment, 1997</i>
UL 1694	<i>Safety Standard for Arc-Fault Circuit Interrupters, 1999</i>
UL	<i>Hazardous Location Equipment Directory, 2004</i>

Other Reference Materials

Cooper Crouse Hinds (CCH Digests)

EIA Standard 598-A	<i>Optical Fiber Cable Color Coding</i>
EIA/TIA-607-1994	<i>Commercial Building Grounding/Bonding Requirements</i>
IEC (6)1010-1	<i>Safety Requirements for Electrical Equipment for Measurement, Control, and Laboratory Use, 1999</i>
ICEA P-54-440	<i>NEMA Pub. No. WC 51, Ampacities of Cables in Open Top Trays</i>
International Association of Electrical Inspectors,	<i>Soares Book on Grounding</i>
National Electric Testing Association,	<i>Standard for Maintenance Testing</i>
Society of Fire Protection Engineers,	<i>Handbook of Fire Protection Engineering, Third Edition, 2002.</i>
Uniform Building Code Chapter 51,	1997
Uniform Federal Accessibility Standard,	<i>Handicapped Wheelchair Lifts</i>

APPENDIX A DOE MODEL ELECTRICAL SAFETY PROGRAM

(THE "DOE MODEL ELECTRICAL SAFETY PROGRAM" WAS CREATED AS OF THE RESULT OF REQUIREMENTS FROM "REPORT OF THE TASK GROUP ON ELECTRICAL SAFETY OF DEPARTMENT OF ENERGY FACILITIES", JANUARY 1993, DOE/EH-0298)

Note: This Electrical Safety Program currently is the only edition currently designated by DOE as a "Model." Therefore, some references and inferences to mandatory compliance may not be the most recent or currently applicable.

EXECUTIVE SUMMARY

The Task Group on Electrical Safety of Department of Energy Facilities, in its January 1993 report, described a Model Electrical Safety Program. This concept has been expanded from its original narrative form into more detailed guidelines, drawing upon the electrical safety program of the Sandia National Laboratory for additional material. This model program is offered to the entire Department of Energy (DOE) complex as guidance to assist in developing and maintaining an effective and sound electrical safety program to ensure the safety and well being of all DOE, including contractor, and subcontractor employees working within any DOE site or facility. The model program has been designed to address the major areas of concern identified by the Task Group.

In essence, an Electrical Safety Program for protecting DOE and contractor workers and facilities should be founded firmly on established requirements of OSHA's electrical safety regulations in 29 CFR 1910 and 29 CFR 1926, National Electrical Code (NEC), DOE Orders and applicable state, local, mine, and tunnel safety standards. This program should establish an electrically safe workplace – free from recognized electrical hazards for all employees. Management should commit to involvement at all levels based on familiarity with the requirements.

Each site should establish an Electrical Safety Committee (ESC) and designate an Authority Having Jurisdiction (AHJ) for interpreting the electrical requirements of OSHA, NEC, and other standards applicable to the site or its facilities. All personnel engaged in electrical work should be trained to have knowledge and understanding of electrical safe work practices. Appropriate electrical testing equipment and personal protective equipment (PPE) should be provided, properly maintained and used.

A proactive preventive maintenance and inspection program for electrical systems and equipment should be in place and staffed by qualified electricians.

All electrical equipment purchases should meet appropriate codes and electrical safety requirements, as determined by a nationally recognized testing laboratory or as approved by the AHJ.

Before a site can have a successful electrical safety program, a continuous improvement effort and commitment must be clearly understood and shared throughout the site.

Each facility must demonstrate continuous improvement for design, construction, operation, maintenance and revisions at the site. Improvements must be tested against changing codes and regulations as they are made.

The ten principles of personal safety are as follows:

1. Plan every job – Planning is the key to preventing incidents therefore, eliminating injuries.
2. Anticipate unexpected events – If a person thinks about what can go wrong and does something about it, then a potential incident can be prevented.
3. Use the right tool for the job – Each employee must make sure the correct tool is used and management must make sure the correct tool is available.

4. Use procedures as tools – Even though procedures are only paper or text, they should be viewed as tools to prevent injury.
5. Isolate the equipment – The best way to avoid accidental release of energy is by isolating the equipment before starting the job (lockout/tagout).
6. Identify the hazard – Employees who are exposed or potentially exposed must be able to recognize when and how they are exposed. Management has the responsibility to provide training to deal with each known hazard, as required.
7. Minimize the hazard – Take all known steps to minimize each hazard and the exposure to each known hazard.
8. Protect the person – The last chance to avoid an injury is to wear PPE. Each person must use all protective equipment that is needed. It is management's responsibility to provide all appropriate PPE.
9. Assess people's abilities – Knowledge and ability help prevent injuries. Each person must recognize their limitations whether physical, mental or emotional. Management must also recognize the same limitations.
10. Audit these principles – The audit should validate the principles related to the people, task, and work environment. It should gauge the visibility of the principles in actual behavior.

The six basic elements of an effective Electrical Safety Program are:

1. Management must have complete commitment to the program;
2. Effective training for all degrees of hazard and a baseline for training must be established;
3. Effective and complete safe electrical work practices must be established;
4. Documentation must be kept for all activities;
5. Electrical safety engineering support must be made; and
6. Oversight for the electrical safety program must also be established.

The model program described in the following pages is presented in terms of purpose, scope, and ownership; performance objectives; responsibilities, authorities, and interfaces; definitions; and implementation guidance. References are listed for more in-depth guidance. A model Charter of the ESC is provided as an appendix.

1.0 PURPOSE, SCOPE, AND OWNERSHIP

1.1 PURPOSE

The purpose of an electrical safety program is to:

- Promote an electrically safe workplace free from unauthorized exposure to electrical hazards for all employees and contractors;
- Provide direction to implement electrical safety requirements of Department of Energy (DOE) orders, criteria, and guides. (See Section. 6, References); and
- Achieve compliance with Occupational Safety and Health Administration (OSHA) regulations in accordance with DOE orders.

An electrically safe workplace will be achieved by:

- Mandating and implementing the electrical subparts of Title 29 Code of Federal Regulations (CFR) 1910 and 29 CFR 1926 as directed by the Secretary of DOE and OSHA; and
- Applying the National Electrical Code (NEC) [National Fire Protection Association (NFPA 70)] and any exceptions by applicable state or local municipal requirements to the design, construction, and maintenance operation of facilities and research and development of electrical/electronic systems.

1.2 SCOPE

The Electrical Safety Program shall apply to all site organizations. These organizations shall conform to:

- The host's site electrical safety requirements, and
- The local, city, county, or state jurisdiction.

1.3 OWNERSHIP

Site management shall appoint an organization to be owner of the Electrical Safety Program.

The Electrical Safety Program governs the electrical safety program owned by each department. The departments will develop and implement safe operating procedures specifically applicable to special electrical hazards in their workplaces.

2.0 PERFORMANCE OBJECTIVES

The Electrical Safety Program has the following objectives:

1. Establish an effective electrical safety program by:
 - Establishing the authority having jurisdiction (AHJ) for interpreting OSHA, NFPA 70 and other requirements for electrical work;
 - Establishing requirements and controls for implementing the program;
 - Providing guidance to all departments, which includes developing and implementing safe operating procedures with electrical requirements;

- Developing an Electrical Safety Program self-assessment process;
 - Establishing measurement criteria and documentation for self-assessment of the Electrical Safety Program;
 - Evaluating the Electrical Safety Program on an annual basis to be followed by action plans in response to findings; and
 - Evaluating each department against the requirements.
2. Ensure a safe workplace with the lowest reasonable risks from electrical hazards by:
- Establishing training programs for qualified and unqualified worker requirements and safe work practices for all personnel engaged in electrical work in accordance with 29 CFR 1910.331-335;
 - Complying with all applicable electrical requirements of 29 CFR 1910 and 29 CFR 1926; the NFPA, American National Standards Institute (ANSI-C2), the National Electrical Safety Code (NESC); DOE orders; and state, county and local revisions of the preceding requirements; and
 - Requiring the development and maintenance of an Electrical Safety Program; and allocation of resources for implementing this program.

3.0 RESPONSIBILITIES, AUTHORITIES, AND INTERFACES

3.1 MANAGEMENT

Management ensures the Electrical Safety Program is integrated into an overall Environmental, Safety, and Health (ES&H) program, selects the Electrical Safety Committee (ESC) Chair, and approves the committee's charter.

3.2 ES&H MANAGERS

ES&H managers provide oversight for implementing the Electrical Safety Program.

3.3 ELECTRICAL SAFETY COMMITTEE

The ESC should act as the AHJ for interpreting electrical codes and regulations. The ESC:

- Presents management with the requirements and training needed to implement the program;
- Advises management of the need to fund and support these requirements;
- Maintains and assists in the implementation of the Electrical Safety Program;
- Develops and maintains the electrical safety manual;
- Assists the departments by interpreting the electrical requirements of DOE orders, criteria, and guides and other codes, standards, and practices;
- Maintains a copy of each interpretation given; and
- Publishes electrical safety bulletins.

The committee interfaces with DOE, all organizations and sites, and other DOE contractors.

3.3.1 ESC Subcommittees

The ESC subcommittees address site-wide electrical safety issues and may be comprised of ESC members as well as non-ESC members. The electrical chair appoints subcommittee chairs, who are not required to be members of the ESC. A majority of the ESC approves all subcommittee reports and recommendations.

3.4 MAINTENANCE MANAGERS

Maintenance managers implement the Electrical Safety Program by developing an electrical preventative maintenance program and providing qualified electricians. They also ensure that managers, first line supervisors, and a staff of crafts workers and their assistants complete all applicable courses of electrical safety training. Maintenance managers also ensure all facilities are maintained in compliance with NEC (NFPA 70) and the NESC (ANSI-C2).

3.5 FACILITY OPERATIONS AND MAINTENANCE DEPARTMENT MANAGERS

Operations managers are responsible for implementing the Electrical Safety Program by providing safe work procedures and permits for high and low voltage work as required. They also provide and implement other critical procedures such as lockout/tagout, testing, and safety-related work practices as required by 29 CFR 1910.331-335. These managers ensure crafts workers of all disciplines and their immediate supervisors working with, or in proximity to, electrical equipment receive:

- Electrical safety awareness training;
- General and job-specific training in safe electrical work practices as required in 29 CFR 1910, Subpart S; and
- Training in NFPA and ANSI codes and standards.

3.6 FACILITY ENGINEERING DESIGN DEPARTMENT MANAGERS

Facility engineering managers are responsible for implementing requirements of this Electrical Safety Program during facility design by ensuring compliance with DOE Order 6430.1A, *General Design Criteria*. These managers also ensure that the electrical engineers and designers attend:

- Electrical safety awareness training;
- General and job-specific training in safe electrical work practices as required in 29 CFR 1910, Subpart S; and
- Training in NFPA, IEEE, and ANSI codes and standards.

In addition, they also ensure all workplace modification designs are in compliance with 29 CFR 1910, Subpart S, and NFPA 70E. They also provide and maintain up-to-date electrical drawings to adequately describe the various building systems and modifications.

3.7 CONSTRUCTION MANAGERS

Construction managers are responsible for implementing and enforcing the requirements of NFPA 70, ANSI C2, and OSHA 29 CFR 1926 during construction of all facilities by providing AHJ-approved certification for electrical inspectors. They also ensure that the inspectors receive training in NFPA 70, OSHA 29 CFR 1926, ANSI C2, and electrical safety awareness.

3.8 SAFETY ENGINEERING MANAGERS

Safety managers provide oversight and customer liaison for electrical safety for the departments. They also provide cognizant electrical safety professionals trained in the application of NEC, OSHA, etc.

3.9 DEPARTMENT MANAGERS

Department managers are responsible for implementing Section 5 of this Electrical Safety Program in their departments by:

- Identifying electrical hazards and documenting them within their departments;
- Familiarizing personnel with electrical hazards;
- Developing and implementing safe operating procedures to ensure safe electrical work practices that mitigate the risks of electrical hazards;
- Developing and implementing an action plan for documenting and correcting electrical deficiencies;
- Conducting periodic inspections of their workplaces and electrical equipment;
- Conducting safety meetings that include electrical safety topics;
- Ensuring personnel receive Electrical Safety Awareness Training and other task specific electrical safety training as required by 29 CFR 1910.332;
- Ensuring their contractors comply with the requirements of this program as applicable; and
- Developing interfaces with their representatives on the ESC.

3.10 EMPLOYEES, VISITORS, ON-SITE CONTRACTORS AND SUBCONTRACTORS

All employees and on-site contractors are responsible for:

- Having an awareness of the electrical hazards in their workplaces;
- Reporting electrical occurrences, shocks, and discovered hazards;
- Reporting all electrical shocks as injuries to the Health Services Department;
- Reading, understanding, and following applicable safe operating procedures having electrical requirements;
- Adopting and implementing safe electrical work practices;
- Attending appropriate Electrical Safety Awareness Training and other equivalent job-specific training as required by 29 CFR 1910.332;
- Using appropriate PPE; and
- Developing interfaces with their representatives on the ESC.

3.11 PURCHASING MANAGERS

Purchasing managers are responsible for specifying that, when available, purchases of electrical equipment and appliances are listed by a nationally recognized testing laboratory (NRTL) such as Underwriters' Laboratories, Inc., (UL).

3.12 ES&H TRAINING MANAGER

These managers are responsible for developing and overseeing electrical safety training courses, including any site-specific electrical safety training courses, as required by the ESC and the Electrical Safety Program.

4.0 DEFINITIONS

Authority Having Jurisdiction (AHJ)

Interprets the requirements of the National Electrical Code (NFPA 70); the National Electrical Safety Code (ANSI C2); 29 CFR 1910, Subpart S; 29 CFR 1926, Subparts K and V; and DOE Order 6430.1A, *General Design Criteria*. Approves electrical equipment, wiring methods, electrical installations, and utilization equipment for compliance. Coordinates these functions with ES&H management and the DOE area or field office.

Approved

Acceptable to the AHJ.

Appliance

Utilization equipment, generally other than industrial, normally built in standardized sizes or types, that is, installed or connected as a unit to perform one or more functions such as refrigerators, air conditioning, and so forth.

Electrical Shock, Reportable

Any electrical shock is classified as an injury and must be reported immediately to health services and supervision.

The employee must not attempt to evaluate the severity of the shock or its effects without medical consultation.

Equipment

Material, fittings, devices, appliances, fixtures, apparatus, and so forth, used as part of, or in connection with, an electrical installation.

Examination

Examination process described in 29 CFR 1910.303(b)(1), *Examination*, and NFPA 70, Article 110-3, *Examination, Identification, and Use for Equipment*. These examinations are performed by a qualified person to ensure that electrical equipment is free from recognized hazards that are likely to cause death or serious physical harm.

Equipment, Utilization

Equipment that uses electrical energy for electronic, electromechanical, chemical, heating, lighting, or similar purposes.

Labeled

Equipment or materials to which a label, symbol, or other identifying mark has been applied by an NRTL.

Listed

Equipment or materials included in a list published by an NRTL

Nationally Recognized Testing Laboratory (NRTL)

An organization acceptable to the AHJ and concerned with product evaluation that maintains periodic inspection of production of listed equipment and materials. The NRTL ensures that the equipment or materials meet appropriate designated standards or have been tested and found suitable for use in a specified manner. (Refer to 29 CFR 1910.7, *Definition and Requirements for a Nationally Recognized Testing Laboratory.*)

Personnel

Employees and on-site contractors.

Qualified Personnel

Personnel trained and familiar with the construction and operation of electrical systems and equipment and their associated hazards. (Refer to 29 CFR 1910.399, *Definitions, Qualified Person*, Notes 1 and 2.)

Qualification Requirements for AHJ Inspectors

Current AHJ recognized electrical inspection certification, or AHJ-approved education and experience in applying the requirements contained in NFPA 70; ANSI C2; 29 CFR 1910, Subpart S; 29 CFR 1926, Subparts K and V, and DOE Order 6430.1A, *General Design Criteria*.

NOTE: AHJ inspectors derive their authority from and coordinate their interpretations through the ESC.

5.0 IMPLEMENTATION GUIDANCE

5.1 INTRODUCTION

The objective of this section is to provide multilevels of management with the criteria to implement this Electrical Safety Program in their organizations. To achieve this objective, managers and ES&H coordinators should:

- Identify electrical hazards in their workplaces;
- Familiarize personnel with these electrical hazards;
- Develop and implement safe operating procedures to ensure safe electrical work practices that mitigate the risks of electrical hazards;
- Conduct periodic inspections of their workplaces and electrical equipment;
- Develop and implement an action plan for documenting and correcting electrical deficiencies, and
- Ensure personnel receive Electrical Safety Awareness Training and other job-specific electrical safety training as required by 29 CFR 1910.332.

Involving all employees and on-site contractors in the electrical safety process is essential to ensure successful implementation of this program.

5.2 ADMINISTRATION AND SAFE CONDUCT OF ELECTRICAL WORK

Performance Objective:

Minimize personnel exposure to electrical hazards.

To ensure the safe conduct of electrical work, each organization must:

- Define, establish, and understand individual accountabilities, authorities, interfaces, roles and responsibilities;
- Properly allocate resources to satisfy requirements;
- Establish administrative controls and procedures to meet the hazard assessment and work practices of 29 CFR 1910.331-335;
- Establish procedures to ensure proper review, approval, work authorization, oversight and documentation for electrical work;
- Conduct safety meetings on job-related electrical issues; and
- Implement 29 CFR 1910.333 lockout/tagout requirements and procedures.

Electrical safety-related work practices will be implemented by each organization in accordance with 29 CFR 1910 as amended in August 1991:

- 1910.331, Qualified and Unqualified Employees
- 1910.332, Training
- 1910.333, Selection and Use of Work Practices
- 1910.334, Use of Equipment
- 1910.335, Safeguards for Personnel Protection

5.3 TRAINING

Performance Objective:

Establish qualification requirements, training programs and certifications where appropriate for all personnel.

- Prior to performing electrical work, personnel must be qualified to perform job-related electrical tasks as required by 29 CFR 1910.332.
- Personnel exposed to the presence of voltages of 50 V or more will have formal electrical safety awareness training. This training can be in a classroom or on-the-job.
- All training must be documented.
- Instructors must provide course outlines.
- Proof of successful completion must be maintained in appropriate files.

Minimum training requirements should include:

- Electrical safety awareness;
- Electrical safety theory;
- Applicable codes, DOE orders, regulations, and standards;
- Demonstrations and hands-on practice;
- Use and care of PPE;
- Job-specific safe electrical work practices; and
- Electrical requirements of safe operating procedures and operating procedures.

Personnel working with high voltage (greater than 600 V) must have specialized electrical awareness training.

Periodic training refresher courses are required to maintain and update skills and code requirements.

Managers and supervisors who oversee electrical work must have completed Electrical Safety Awareness Training at a level commensurate with the level of work being performed.

5.4 PERSONAL PROTECTIVE EQUIPMENT

Performance Objective:

Provide PPE for electrical work. Establish documented procedures for its use, care, maintenance, and testing. [Guidance for these procedures can be found in 29 CFR 1910.137 and 29 CFR 1910.268(f).]

Managers shall ensure adequate resources are available to provide PPE in compliance with applicable codes and standards. In addition, they shall ensure that:

- Personnel are trained in its use in accordance with documented procedures;
- Procedures are established and implemented for documented controls of protective equipment such as inventory, storage, maintenance, and testing;
- Protective equipment requirements and usages are specified in the safe operating procedures;
- Protective equipment is inspected prior to each use;
- High-voltage equipment is inspected prior to each use according to appropriate recognized standards; and
- Grounding equipment, cables, clusters, and sticks, are inspected annually and prior to each use.

5.5 ELECTRICAL PREVENTIVE MAINTENANCE (EPM) PROGRAM

Performance Objective:

Establish an EPM program to ensure safe and reliable operation of electrical wiring, protection devices, and operating equipment such as switches, circuit breakers, utilization equipment, and appliances.

Managers will ensure that resources are available to provide for compliance with applicable codes and standards. In addition, they will ensure that:

- Procedures are established for EPM intervals, inspections, tests, and servicing requirements;
- Records are maintained of all tests, inspections, servicing, and inventories;
- Documentation, tests, test intervals, and procedures are guided by the recommendations of NFPA 7013, manufacturer's recommendations, industry standards, or DOE-adopted standards or regulations;
- Copies of all manufacturer's installation, operating, and maintenance instructions are maintained in a department file; and
- EPM work is performed only by qualified personnel.

5.6 CODE COMPLIANCE

Performance Objective:

Ensure compliance with all applicable electrical requirements of DOE Orders, the NFPA, ANSI C2, and the respective parts of 29 CFR 1910 and 29 CFR 1926.

All electrical installations and equipment are subject to inspection and the approval of the AHJ.

5.6.1 Code and Regulation Inspectors

Inspectors representing the AHJ will be qualified as required by the AHJ in:

- National Electrical Code (NFPA 70); 29 CFR 1910, Subpart S; and
- 29 CFR 1926, Subparts K and V.

Managers will ensure adequate resources are available to provide for compliance with applicable codes and standards. In addition, they will ensure that:

- Inspections are performed by qualified personnel on all new electrical work and equipment, including utilization equipment. These inspections will be in accordance with 29 CFR 1910, Subpart S.
- Any potential imminent danger situation is corrected immediately or personnel is removed from the hazard.
- Resources are available to abate all true electrically hazardous conditions.
- Inspections are documented. Inspection records, deficiencies, and corrective actions will be maintained in a department file.
- Examinations are performed on all equipment that is not listed or labeled by a NRTL.
- Record drawings of all electrical systems and equipment are maintained and a rigid system exists for recording changes and correcting the drawings to reflect those changes.

5.6.2 Authority Having Jurisdiction (AHJ)

The ESC is the AHJ for interpreting electrical codes, standards, and regulations.

5.6.3 Exemption and Waivers

All requests for code and regulation exemptions and waivers will first be submitted to the ESC for action.

Requests for exemptions and waivers will include:

- A description of the problem and the reason for requesting noncompliance; code or regulation references;
- Proposed mitigative steps to be taken such as warning signs, barriers, and procedures to provide equivalent protection; and
- Proposed dates for the variance.

Normally, exemptions and waivers are not granted for: 1) longer than 180 days, 2) the time it takes to correct the deficiency, or 3) the duration of an approved program or operation. (See Section 4.0, *Definitions*.) The DOE Assistant Secretary grants exemptions and waivers for Environment, Safety, and Health in accordance with DOE Document DOE/ID-10600.

5.6.4 Equipment and Materials Approval

All electrical equipment and materials for facility wiring, and similar R&D wiring, as defined by NFPA 70 will be approved in accordance with Article 90-7, *Examination of Equipment for Safety*, and Article 110-3, *Examination, Identification, Installation, and Use of Equipment*.

5.6.5 Utilization Equipment

Utilization equipment is addressed in 29 CFR 1910.302 and 303. This document makes it clear that utilization equipment is subject to the same approval and acceptance requirements as in Section 5.6.4 of this document.

- To be acceptable for installation and use, utilization equipment will be listed or labeled by a NRTL.
- Utilization equipment that is not listed or labeled will meet one of the requirements of 29 CFR 1910.399, Acceptable, (i), (ii), or (iii).
- Utilization equipment that is not listed or labeled will be examined, accepted, and documented by a qualified person.
- Utilization equipment must be used in accordance with its listing and labeling requirements.

NOTE: Utilization equipment includes laboratory and shop equipment, appliances, or other devices that operate from an electrical energy source.

5.6.6 Test Instruments and Equipment

Test instruments and equipment are intended only for use by qualified personnel and shall be used in accordance with 29 CFR 1910.334(c). In addition, a qualified person will inspect all test instruments and equipment to ensure it is safe to use as intended by the manufacturer. If found unsafe, they will not be used unless warning labels, special operating procedures, or modifications are used to mitigate the hazard.

- Test instruments and equipment will be visually inspected before each use.

- Test instruments and equipment and their accessories shall be electrically rated for their intended use.

5.6.7 Equipment of Foreign Manufacture

All equipment of foreign manufacture is subject to acceptance as defined in 29 CFR 1910.399. Listing and labeling of equipment by foreign laboratories or standards may require examination to ensure the equipment is wired to the electrical requirements of NFPA 70 as well as 29 CFR 1910.334.

5.6.8 Appliances for Personal Use

All appliances for personal use in the workplace such as coffee pots, refrigerators, and radios should be listed and exhibit the label of a NRTL.

5.6.9 Qualified Examiners of Research and Development (R&D) Equipment

R&D managers may appoint at least one person in their organization to examine equipment and materials for approval prior to use. This person(s) will be knowledgeable in specified code and regulation requirements for examination and with the NRTL process. This person will contact an electrical safety staff member for guidance in examination procedures.

NOTE: If an organization does not have a qualified person, an electrical safety staff member should be contacted for assistance.

5.7 ENGINEERING AND INSPECTION

Performance objective:

Provide electrical safety engineering and inspection resources to ensure this Electrical Safety Program and all mandatory codes and regulations are implemented.

5.7.1 R&D and Facility Requirements

R&D and facility organizations will ensure their electrical systems are constructed and maintained in compliance with the electrical safety criteria.

5.7.2 Certified Electrical Inspectors

Certified (AHJ-approved certification) electrical code inspectors will be provided for construction and maintenance work.

5.7.3 Inspectors

Inspectors will have an AHJ-approved certification in the National Electrical Code and will be qualified in the electrical safety requirements of 29 CFR 1910 and 29 CFR 1926. In addition, inspectors will:

- Have the responsibility of inspecting electrical work performed during both maintenance projects and construction projects;
- Provide documentation of electrical inspections of both maintenance projects and construction projects;
- Participate in the quality assurance (QA) process and QA review process; provide an inspection resource for all organizations;

- Participate in the QA programs of other organizations as required, and
- Review and sign off on safe operating procedures with electrical requirements.

5.7.4 Qualified Personnel

All persons performing electrical work will be qualified in accordance with the requirements of 29 CFR 1910.331 through 335. Qualified personnel will perform electrical work as follows:

- Connection to and operation of circuit breakers in building electrical panels may be performed only by qualified electricians.

NOTE: In an emergency, a knowledgeable employee may operate a circuit breaker in a building only to disconnect power

- Power cords and plugs, rated 15 A or 20 A, provided with electrical equipment and intended to be installed by the user, will be installed by a qualified person. The manufacturer's instructions will be followed explicitly. A polarity and ground continuity test will be performed on the cord and plug set before inserting the plug into a receptacle.
- Qualified electronic technicians and electricians will perform all other electrical work.

5.7.5 Quality Assurance

Qualified personnel will participate in the QA process and provide design input and oversight as follows:

- Review electrical plans for all new, or modifications to, facilities and R&D projects;
- Review safe operating procedures for Electrical Safety Program compliance;
- Periodically inspect wiring materials, connections, and components of existing facilities and R&D projects; and
- Review drawings, specifications, and manufacturer's installation operation instructions for all electrical equipment prior to connection and operations.

5.7.6 Electrical Occurrence Reports

Electrical occurrences, including electrical shocks, shall be reported in accordance with DOE Order 5000.3A.

6.0 REFERENCES

6.1 IMPLEMENTING REFERENCES

29 CFR 1910, Subpart S, and 29 CFR 1926, Subparts K and V.

DOE Electrical Safety Guidelines, DOE/ID 10600.

Electrical Safety Criteria for Research and Development Activities, DOE/EV-0051/1, Interim Criteria.

Electrical Safety Task Force Report.

Factory Mutual Approval Guide.

Factory Mutual Data Sheets.

General Design Criteria, DOE Order 6430.1A.

International Association of Electrical Inspectors, Inc. (IAEI).

International Congress of Building Officials (ICBO).

Institute of Electronic and Electrical Engineers (IEEE).

National Electrical Code, National Fire Protection Association 70.

National Electrical Safety Code, American National Standards Institute standard C2.

National Fire Codes, National Fire Protection Association (NFPA). (Refer to Section 6.3.)

Standard for Fire Protection of DOE Electronic Computer/Data Processing Systems, DOE/EP0108.

Underwriters Laboratories, Inc., *Listings and Classifications Directory*.

Uniform Building Code, latest edition and supplements.

Uniform Fire Code, latest edition and supplements.

Williams- Steiger Occupational Safety and Health Act of 1970, standards:

- Occupational Safety and Health Standards, 29 CFR 1910, *General Industry Standards*.
- Safety and Health Regulations for Construction, 29 CFR 1926.

6.2 DEVELOPMENTAL REFERENCES

Conduct of Operations Requirements for DOE Facilities, DOE Order 5480.19.

Environmental Protection, Safety, and Health Protection Information Reporting Requirements, DOE Order 5484.1.

Environmental Protection, Safety, and Health Protection Standards, DOE Order 5480.4.

Fire Protection, DOE Order 5480.7.

General Design Criteria, DOE Order 6430.1A.

General Operations Quality Assurance, Revision II, DOE/AL Order 5700.613.

Occurrence Reporting and Processing of Operations Information, DOE Order 5000.3A.

Maintenance Management Program, DOE Order 4330.4A.

Maintenance Management Program Guidance, DOE/AL 4330.4A.

Protection of Electronic Computers and Data Processing Equipment, DOE/EP-0108.

Safety Analysis and Review, DOE Order 5481.1 B.

6.3 NFPA REFERENCES WITH ELECTRICAL REQUIREMENTS

Volume 1

- 1 Fire Prevention Code
- 20 Standard for the Installation of Centrifugal Fire Pumps
- 30 Flammable and Combustible Liquids Code
- 30A Automotive and Marine Service Station Code

Volume 2

- 33 Standard for Spray Application Using Flammable and Combustible Liquids
- 34 Standard for Dipping and Coating Processes Using Flammable or Combustible Liquids
- 45 Standard on Fire Protection for Laboratories Using Chemicals
- 50 Standard for Bulk Oxygen Systems at Consumer Sites
- 50A Standard for Gaseous Hydrogen Systems at Consumer Sites
- 50B Standard for Liquefied Hydrogen Systems at Consumer Sites
- 54 National Fuel Gas Code
- 58 Standard for the Storage and Handling of Liquefied Petroleum Gases
- 69 Standard on Explosion Prevention Systems

Volume 3

- 70 National Electrical Code (NEC)
- 70B Electrical Equipment Maintenance
- 70E Standard for Electrical Safety Requirements for Employee Work Places
- 72A Standard for the Installation, Maintenance, and Use of Local Protective Signaling Systems for Guard's Tour, Fire Alarm, and Supervisory Service
- 72B Standard for the Installation, Maintenance, and Use of Proprietary Protective Signaling Systems
- 72E Standard on Automatic Fire Detectors
- 72F Standard for the Installation, Maintenance, and Use of Emergency Voice/Alarm Communication Systems
- 75 Standard for the Protection of Electronic Computer/Data Processing Equipment
- 78 Lightning Protection Code
- 79 Electrical Standard for Industrial Machinery

Volume 4

- 88B Standard for Repair Garages
- 90A Standard for the Installation of Air Conditioning and Ventilation Systems
- 90B Standard for the Installation of Warm Air Heating and Air Conditioning Systems
- 91 Standard for the Installation of Blower and Exhaust systems
- 96 Standard for the Installation of Equipment for the Removal of Smoke and Grease-Laden Vapors from Commercial Cooking Equipment

Volume 5

- 99 Standard for Health Care Facilities
- 99B Standard for Hypobaric Facilities
- 101 Code for Safety to Life from Fire in Buildings and Structures (the Life Safety Code)

DOE-HDBK-1092-2013

- 102 Standard for Assembly Seating, Tents, and Membrane Structures
- 110 Standard for Emergency and Standby Power Systems

Volume 6

- 122 Standard for the Storage of Flammable and Combustible Liquids Within Underground Metal and Nonmetal Mines (Other than Coal)
- 220 Standard on Types of Building Construction
- 241 Standard for Safeguarding Construction, Alteration, and Demolition Operations
- 318 Standard for the Protection of Clean Rooms
- 321 Standard on Basic Classification of Flammable and Combustible Liquids
- 385 Standard for Tank Vehicles for Flammable and Combustible Liquids

Volume 7

- 407 Standard for Aircraft Fueling Servicing
- 493 Standard for Intrinsically Safe Apparatus and Associated Apparatus for use in Class I, II, and III, Division 1 Hazardous Locations [Discontinued see Underwriters' Laboratories, Inc. (UL), UL913, Intrinsically Safe Apparatus and Associated Apparatus for Use in Class I, II and III, Division 1, Hazardous Locations]
- 495 Code for the Manufacture, Transportation, Storage, and Use of Explosive Materials
- 496 Standard for Purges and Pressurized Enclosures for Electrical Equipment
- 498 Standard for Explosives Motor Vehicle Terminals
- 704 Standard Systems for the Identification of the Fire Hazards of Materials

Volume 8

- 1141 Standard for Fire Protection in Planned Building Groups
- 1221 Standard for the Installation, Maintenance, and Use of Public Fire Service Communication Systems

Volume 9

- 68 Guide for Explosion Venting
- 70B Recommended Practices for Electrical Equipment Maintenance
- 72G Guide for the Installation, Maintenance, and Use of Notification Appliances for Protective Signaling Systems
- 72H Guide for Testing Procedures for Local, Auxiliary, Remote Station, and Proprietary Signaling Systems
- 77 Recommended Practices on Static Electricity
- 80A Recommended Practice for Protection of Buildings from Exterior Fire Exposure
- 97M Standard Glossary of Terms Relating to Chimneys, Vents, and Heat-Producing Appliances

Volume 10

- 325M Fire Hazard Properties of Flammable Liquids, Gases, and Volatile Materials
- 328 Recommended Practices for the Control of Flammable and Combustible Liquids and Gases in Manholes and Sewers

Volume 11

- 497A Recommended Practice for Classification of Class I Hazardous (Classified) Locations for Electrical Installations in Chemical Process Areas
- 497M Manual for Classification of Gases, Vapors, and Dust for Electrical Equipment in Hazardous (Classified) Locations
- 802 Recommended Fire Protection Practice for Nuclear Research Reactors
- 901 Uniform Coding for Fire Protection
- 907M Manual on the Investigation of Fires of Electrical Origin

CHARTER OF THE ELECTRICAL SAFETY COMMITTEE (ESC)

I. PURPOSE, OBJECTIVES, AND RESPONSIBILITIES

- A. Provide the contractor or company with a competent technical resource for identifying, recommending resolution of, and communicating electrical safety issues.
- B. Enhance electrical safety by reducing risk, mitigating hazards, and providing root cause analysis in electrical energy distribution and applications in R&D laboratories and other workplaces.
- C. Identify the need for and establish new electrical safety initiatives and programs.
- D. Develop, review, and approve electrical safety training programs.
- E. Review all occurrence reports involving electrical issues, and participate in the root cause analysis process.
- F. Participate in DOE electrical safety programs such as the DOE ESC, the development and maintenance of the DOE Electrical Safety Guidelines document, and the process for requesting and monitoring exemptions and waivers to guidelines.
- G. The committee shall be responsible for implementation of this program.

II. MEMBERSHIP

- A. Site management appoints the chair of the ESC and approves the charter.
- B. The chair shall appoint a secretary.
- C. The committee shall be made up of one member and an alternate appointed by each line organization or division and appropriate trades organization(s).
- D. Advisors to the ESC shall attend and participate in committee meetings and activities. Advisors shall be line organization personnel who have special interests and/or knowledge concerning electrical safety. Advisors shall be approved by the committee.
- E. The DOE area or field office appoints a representative to the ESC to coordinate electrical safety concerns involving the ESC and DOE.
- F. Committee members shall be knowledgeable in electrical safety through education and/or experience and shall be actively pursuing electrical engineering, electrical safety, or R&D functions in the performance of their duties and shall be committed to the broad electrical safety concerns of the site and its employees.

III. COMMITTEE AUTHORITY

The ESC shall be the authority having jurisdiction (AHJ) for the implementation of the National Electrical Code, 29 CFR 1910, Subpart S, and 29 CFR 1926, Subpart K.

IV. OPERATIONAL GUIDELINES

- A. The committee shall meet at least quarterly, and the meeting shall be called by the chair or by the secretary in the absence of the chair.
- B. ESC bulletins and all revisions to the Electrical Safety Manual will be reviewed by the ESC.
- C. Subcommittees to address particular areas of electrical safety may be formed at the direction of the chair, by vote of the committee, or by a voting member with the concurrence of the chair or committee. At least one ESC member shall serve on each subcommittee.
- D. Designated alternate members shall vote in the absence of members and shall provide consultation and advice to individual members or the whole committee, as requested.
- E. The chair shall appoint someone to serve as the chair in the chair's absence.
- F. The secretary shall record and distribute ESC meeting minutes.

V. MANAGEMENT REVIEW

Conduct of the meetings and any resulting recommendations (with supporting documentation) will be communicated to ES&H management through the meeting minutes.

APPENDIX B ACRONYMS AND DEFINITIONS

ACRONYMS

A	Ampere
AC	alternating current
AED	automated external defibrillators
AFCI	arc fault circuit interrupter
AHJ	authority having jurisdiction
AM	amplitude modulation
AMG	American wire gauge
ANSI	American National Standards Institute
ASME	American Society of Mechanical Engineers
ASTM	American Society for Testing and Materials
CFR	Code of Federal Regulations
CMAA	Crane Manufacturers Association of America
CPR	cardiopulmonary resuscitation
DC	direct current
DOD	Department of Defense
DOE	Department of Energy
E	electricity
EED	electro explosive device
EGC	equipment grounding conductors
EM	electromagnetic
EMI	electromagnetic interference
EMR	electromagnetic radiation
ESC	Electrical Safety Committee
ES&H	environment, safety, and health
EPM	electrical preventive maintenance
FR	fire-resistant
FLC	Full Load Current
FM	frequency modulation
GEC	grounding electrode conductor
GFCI	ground fault circuit interrupter
GFPE	ground fault protection of equipment
HF	high-frequency

DOE-HDBK-1092-2013

Hz	hertz
ICEA	Insulated Cable Engineers Association
IEEE	Institute of Electrical and Electronic Engineers
IEC	International Electro-Technical Commission
IES	Illumination Engineering Society of North America
ISA	Instrument Society of America
J	Joule
kA	kiloampere
KCmil	thousand circular mils
Kg	kilogram
kV	kilovolts
kW	kilowatt
m	meter
mA	milliamp/milliampere
MHz	megahertz
mm	millimeter
MOV	metal oxide varistor
MPE	maximum permissible exposure
MS	military standard
NEC	National Electrical Code
NEMA	National Electrical Manufacturers Association
NESC	National Electrical Safety Code
NFPA	National Fire Protection Association
NIST	National Institute of Standards and Technology
NM	non-metallic
NRTL	Nationally Recognized Testing Laboratory
O	DOE Order
OCPD	overcurrent protection device
OGW	overhead ground wire
OSHA	Occupation Safety and Health Administration
PPE	personal protection equipment
PVC	polyvinyl chloride
R&D	research and development
RF	radio frequency
RFMW	radio frequency microwave

SA	specific absorption
TFE	teflon insulation
UBC	Uniform Building Code
UL	Underwriters Laboratory, Inc.
UPS	uninterruptible power supply
UHF	ultra-high frequency
V	volt
V AC	volts alternating current
V DC	volts direct current
VHF	very high frequency
W	watt

DEFINITIONS

DEFINITIONS APPLICABLE TO 29 CFR 1910, OCCUPATIONAL SAFETY AND HEALTH STANDARDS, SUBPART S

Acceptable – An installation or equipment is acceptable to the Assistant Secretary of Labor, and approved within the meaning of this Subpart S:

1. If it is accepted, or certified, or listed, or labeled, or otherwise determined to be safe by a nationally recognized testing laboratory; or
2. With respect to an installation or equipment of a kind which no nationally recognized testing laboratory accepts, certifies, lists, labels, or determines to be safe, if it is inspected or tested by another Federal agency, or by a State, municipal, or other local authority responsible for enforcing occupational safety provisions of the National Electrical Code, and found in compliance with the provisions of the National Electrical Code, as applied in this subpart; or
3. With respect to custom-made equipment, or related installations, which are designed, fabricated for, and intended for use by a particular customer, if it is determined to be safe for its intended use by its manufacturer on the basis of test data which the employer keeps and makes available for inspection to the Assistant Secretary and his authorized representatives. Refer to 1910.7 for definition of nationally recognized testing laboratory.

Accepted – An installation is "accepted" if it has been inspected and found by a nationally recognized testing laboratory to conform to specified plans or to procedures of applicable codes.

Accessible (As applied to wiring methods) – Capable of being removed or exposed without damaging the building structure or finish, or not permanently closed in by the structure or finish of the building (see "concealed" and "exposed").

Accessible (As applied to equipment) – Admitting close approach; not guarded by locked doors, elevation, or other effective means (see "Readily accessible").

Ampacity – The Current-carrying capacity of electric conductors expressed in amperes.

Appliances – Utilization equipment, generally other than industrial, normally built in standardized sizes or types, which is installed or connected as a unit to perform one or more functions, such as clothes washing, air conditioning, food mixing, deep frying, etc.

Approved – Acceptable to the authority enforcing this subpart. The authority enforcing this subpart is the Assistant Secretary of Labor for Occupational Safety and Health. The definition of "acceptable" indicates what is acceptable to the Assistant Secretary of Labor, and therefore approved within the meaning of this subpart.

Approved for the purpose – Approved for a specific purpose, environment, or application described in a particular standard requirement. Suitability of equipment or materials for a specific purpose, environment or application may be determined by a nationally recognized testing laboratory, inspection agency or other organization concerned with product evaluation as part of its listing and labeling program (see "Labeled" or "Listed").

Armored cable-Type AC – A fabricated assembly of insulated conductors in a flexible metallic enclosure.

Askarel – A generic term for a group of nonflammable synthetic chlorinated hydrocarbons used as electrical insulating media. Askarels of various compositional types are used. Under arcing conditions the gases produced, while consisting predominantly of noncombustible hydrogen chloride, can include varying amounts of combustible gases, depending upon the askarel type.

Attachment plug (Plug cap) (Cap) – A device which, by insertion in a receptacle, establishes connection between the conductors of the attached flexible cord and the conductors connected permanently to the receptacle.

Automatic – Self-acting, operating by its own mechanism when actuated by some impersonal influence, as, for example, a change in current strength, pressure, temperature, or mechanical configuration.

Bare conductor – See "Conductor."

Bonding – The permanent joining of metallic parts to form an electrically conductive path which will assure electrical continuity and the capacity to conduct safely any current likely to be imposed.

Bonding jumper – Are liable conductor to assure the required electrical conductivity between metal parts required to be electrically connected.

Branch circuit – The circuit conductors between the final overcurrent device protecting the circuit and the outlet(s).

Building – A structure which stands alone or which is cut off from adjoining structures by fire walls with all openings therein protected by approved fire doors.

Cabinet – An enclosure designed either for surface or flush mounting, and provided with a frame, mat, or trim in which a swinging door or doors are or may be hung.

Cable tray system – A cable tray system is a unit or assembly of units or sections, and associated fittings, made of metal or other non-combustible materials forming a rigid structural system used to support cables. Cable tray systems include ladders, troughs, channels, solid bottom trays, and other similar structures.

Cable bus – Cable bus is an approved assembly of insulated conductors with fittings and conductor terminations in a completely enclosed, ventilated, protective metal housing.

Center pivot irrigation machine – A center pivot irrigation machine is a multi-motored irrigation machine which revolves around a central pivot and employs alignment switches or similar devices to control individual motors.

Certified – Equipment is "certified" if it: (a) has been tested and found by a nationally recognized testing laboratory to meet nationally recognized standards or to be safe for use in a specified manner, or (b) is of a kind whose production is periodically inspected by a nationally recognized testing laboratory, and (c) it bears a label, tag, or other record of certification.

Circuit breaker –

1. (600 V nominal, or less) – A device designed to open and close a circuit by non-automatic means and to open the circuit automatically on a predetermined overcurrent without injury to itself when properly applied within its rating.
2. (Over 600 V, nominal) – A switching device capable of making, carrying, and breaking currents under normal circuit conditions, and also making, carrying for a specified time, and breaking currents under specified abnormal circuit conditions, such as those of short circuit.

Class I locations – Class I locations are those in which flammable gases or vapors are or may be present, in the air in quantities sufficient to produce explosive or ignitable mixtures. Class I locations include the following:

1. *Class I, Division I.* A Class I, Division I location is a location:
 1. In which hazardous concentrations of flammable gases or vapors may exist under normal operating conditions; or
 2. In which hazardous concentrations of such gases or vapors may exist frequently because of repair or maintenance operations or because of leakage; or
 3. In which breakdown or faulty operation of equipment or processes might release hazardous concentrations of flammable gases or vapors, and might also cause simultaneous failure of electric equipment.

NOTE: This classification usually includes: locations where volatile flammable liquids or liquefied flammable gases are transferred from one container to another; interiors of spray booths and areas in the vicinity of spraying and painting operations where volatile flammable solvents are used; locations containing open tanks or vats of volatile flammable liquids; drying rooms or compartments for the evaporation of flammable solvents; locations containing fat and oil extraction equipment using volatile flammable solvents; portions of cleaning and dyeing plants where flammable liquids are used; gas generator rooms and other portions of gas manufacturing plants where flammable gas may escape; inadequately ventilated pump rooms for flammable gas or for volatile flammable liquids; the interiors of refrigerators and freezers in which volatile flammable materials are stored in open, lightly stoppered, or easily ruptured containers; and all

other locations where ignitable concentrations of flammable vapors or gases are likely to occur in the course of normal operations.

2. *Class I, Division 2.* A Class I, Division 2 location is a location:

- i. In which volatile flammable liquids or flammable gases are handled, processed, or used, but in which the hazardous liquids, vapors, or gases will normally be confined within closed containers or closed systems from which they can escape only in case of accidental rupture or breakdown of such containers or systems, or in case of abnormal operation of equipment; or
- ii. In which hazardous concentrations of gases or vapors are normally prevented by positive mechanical ventilation, and which might become hazardous through failure or abnormal operations of the ventilating equipment; or
- iii. That is adjacent to a Class 1, Division 1 location, and to which hazardous concentrations of gases or vapors might occasionally be communicated, unless such communication is prevented by adequate positive-pressure ventilation from a source of clean air, and effective safeguards against ventilation failure are provided.

NOTE: This classification usually includes locations where volatile flammable liquids or flammable gases or vapors are used, but which would become hazardous only in case of an accident, or of some unusual operating condition. The quantity of flammable material that might escape in case of accident, the adequacy of ventilating equipment, the total area involved, and the record of the industry or business with respect to explosions or fires are all factors that merit consideration in determining the classification and extent of each location.

Piping without valves, checks, meters, and similar devices would not ordinarily introduce a hazardous condition even though used for flammable liquids or gases. Locations used for the storage of flammable liquids or a liquefied or compressed gases in sealed containers would not normally be considered hazardous unless also subject to other hazardous conditions.

Electrical conduits and their associated enclosures separated from process fluids by a single seal or barrier are classed as a Division 2 location if the outside of the conduit and enclosures is a nonhazardous location.

Class II locations – Class II locations are those that are hazardous because of the presence of combustible dust. Class II locations, include the following:

1. *Class II, Division 1.* A Class II, Division 1 location is a location:

- i. In which combustible dust is or may be in suspension in the air under normal operating conditions, in quantities sufficient to produce explosive or ignitable mixtures; or
- ii. Where mechanical failure or abnormal operation of machinery or equipment might cause such explosive or ignitable mixtures to be produced, and might also provide a source of ignition through simultaneous failure of electric equipment, operation of protection devices, or from other causes; or
- iii. In which combustible dusts of an electrically conductive nature may be present.

NOTE: This classification may include areas of grain handling and processing

plants, starch plants, sugar-pulverizing plants, malting plants, hay-grinding plants, coal pulverizing plants, areas where metal dusts and powders are produced or processed, and other similar locations which contain dust producing machinery and equipment (except where the equipment is dust-tight or vented to the outside). These areas would have combustible dust in the air, under normal operating conditions, in quantities sufficient to produce explosive or ignitable mixtures. Combustible dusts which are electrically non-conductive include dusts produced in the handling and processing of grain and grain products, pulverized sugar and cocoa, dried egg and milk powders, pulverized spices, starch and pastes, potato and wood flour, oil meal from beans and seed, dried hay, and other organic materials which may produce combustible dusts when processed or handled. Dusts containing magnesium or aluminum are particularly hazardous and the use of extreme caution is necessary to avoid ignition and explosion.

2. *Class II, Division 2.* A Class II, Division 2 location is a location in which:

- i. Combustible dust will not normally be in suspension in the air in quantities sufficient to produce explosive or ignitable mixtures, and dust accumulations are normally insufficient to interfere with the normal operation of electrical equipment or other apparatus; or
- ii. Dust may be in suspension in the air as a result of infrequent malfunctioning of handling or processing equipment, and dust accumulations resulting there from may be ignitable by abnormal operation or failure of electrical equipment or other apparatus.

NOTE: This classification includes locations where dangerous concentrations of suspended dust would not be likely, but where dust accumulations might form on, or in the vicinity of, electric equipment. These areas may contain equipment from which appreciable quantities of dust would escape under abnormal operating conditions or be adjacent to a Class II Division 1 location, as described above, into which an explosive or ignitable concentration of dust may be put into suspension under abnormal operating conditions.

Class III locations – Class III locations are those that are hazardous because of the presence of easily ignitable fibers or flyings but in which such fibers or flyings are not likely to be in suspension in the air in quantities sufficient to produce ignitable mixtures. Class III locations include the following:

1. *Class III, Division 1.* A Class III, Division I location is a location in which easily ignitable fibers or materials producing combustible flyings are handled, manufactured, or used.

NOTE: Such locations usually include some parts of: rayon, cotton, and other textile mills; combustible fiber manufacturing and processing plants; cotton gins and cottonseed mills; flax-processing plants; clothing manufacturing plants; woodworking plants, and establishments; and, industries involving similar hazardous processes or conditions.

Easily ignitable fibers and flyings include rayon, cotton (including cotton linters and cotton waste), sisal or henequen, istle, jute, hemp, tow, cocoa fiber, oakum, baled waste kapok, Spanish moss, excelsior, and other materials of similar nature.

2. *Class III, Division 2.* A Class III, Division 2 location is a in which easily ignitable fibers are stored or handled, except in the process of manufacture.

Collector ring – A collector ring is an assembly of slip rings for transferring electrical energy from a stationary to a rotating member.

Concealed – Rendered inaccessible by the structure or finish of the building. Wires in concealed raceways are considered concealed, even though they may become accessible by withdrawing them. (See "Accessible (As applied to wiring methods)")

Conductor –

- i. *Bare* – A conductor having no covering or electrical insulation whatsoever.
- ii. *Covered* – A conductor encased within material of composition or thickness that is not recognized as electrical insulation.
- iii. *Insulated* – A conductor encased within material of composition and thickness that is recognized as electrical insulation.

Conduit body – A separate portion of a conduit or tubing system that provides access through a removable cover(s) to the interior of the system at a junction of two or more sections of the system or at a terminal point of the system. Boxes such as FS and FD or larger cast or sheet metal boxes are not classified as conduit bodies.

Controller – A device, or group of devices, that serves to govern, in some pre-determined manner, the electric power delivered to the apparatus to which it is connected.

Cooking unit, counter-mounted – A cooking appliance designed for mounting in or on a counter and consisting of one or more heating elements, internal wiring, and built-in or separately mountable controls (see "Oven, wall-mounted").

Covered conductor – See "Conductor."

Cutout (Over 600 V, nominal) – An assembly of a fuse support with either a fuseholder, fuse carrier, or disconnecting blade. The fuseholder or fuse carrier may include a conducting element (fuse link), or may act as the disconnecting blade by the inclusion of a nonfusible member.

Cutout box – An enclosure designed for surface mounting and having swinging doors or covers secured directly to and telescoping with the walls of the box proper (see "Cabinet").

Damp Location – See "Location."

Dead front – Without live parts exposed to a person on the operating side of the equipment.

Device – A unit of an electrical system which is intended to carry but not utilize electric energy.

Dielectric heating – Dielectric heating is the heating of a nominally insulating material due to its own dielectric losses when the material is placed in a varying electric field.

Disconnecting means – A device, or group of devices, or other means by which the conductors of a circuit can be disconnected from their source of supply.

Disconnecting (or Isolating) switch – (Over 600 V, nominal) A mechanical switching device used for isolating a circuit or equipment from a source of power.

Dry location – See "Location."

Electric sign – A fixed, stationary, or portable self-contained, electrically illuminated utilization equipment with words or symbols designed to convey information or attract attention.

Electrically-Safe Work Condition – A state in which an electrical conductor or circuit part has been disconnected from energized parts, locked/tagged in accordance with established standards, tested to ensure the absence of voltage, and grounded, if determined necessary.

Enclosed – Surrounded by a case, housing, fence or walls which will prevent persons from accidentally contacting energized parts.

Enclosure – The case or housing of apparatus, or the fence or walls surrounding an installation to prevent personnel from accidentally contacting energized parts, or to protect the equipment from physical damage.

Equipment – A general term including material, fittings, devices, appliances, fixtures, apparatus, and the like, used as a part of, or in connection with, an electrical installation.

Equipment grounding conductor – See "Grounding conductor, equipment."

Explosion-proof apparatus – Apparatus enclosed in a case that is capable of withstanding an explosion of a specified gas or vapor which may occur within it and of preventing the ignition of a specified gas or vapor surrounding the enclosure by sparks, flashes, or explosion of the gas or vapor within, and which operates at such an external temperature that it will not ignite a surrounding flammable atmosphere.

Exposed (As applied to live parts) – Capable of being inadvertently touched or approached nearer than a safe distance by a person. It is applied to parts not suitably guarded, isolated, or insulated (see "Accessible" and "Concealed").

Exposed (As applied to wiring methods) – On or attached to the surface or behind panels designed to allow access (see "Accessible (As applied to wiring methods)").

Exposed (For the purposes of 1910.308(e), Communications systems.) – Where the circuit is in such a position that in case of failure of supports or insulation, contact with another circuit may result.

Externally operable – Capable of being operated without exposing the operator to contact with live parts.

Feeder – All circuit conductors between the service equipment, or the generator switchboard of an isolated plant, and the final branch circuit overcurrent device.

Fitting – An accessory such as a locknut, bushing, or other part of a wiring system that is intended primarily to perform a mechanical rather than an electrical function.

Fuse (Over 600 V, nominal) – An overcurrent protective device with a circuit opening fusible part that is heated and severed by the passage of overcurrent through it. A fuse comprises all the parts that form a unit capable of performing the prescribed functions. It may or may not be the complete device necessary to connect it into an electrical circuit.

Ground – A conducting connection, whether intentional or accidental, between an electrical circuit or equipment and the earth, or to some conducting body that serves in place of the earth.

Grounded – Connected to earth or to some conducting body that serves in place of the earth.

Grounded, effectively (Over 600 V, nominal) – Permanently connected to earth through a ground connection of sufficiently low impedance and having sufficient ampacity that ground fault current which may occur cannot build up to voltages dangerous to personnel.

Grounded conductor – A system or circuit conductor that is intentionally grounded.

Grounding conductor – A conductor used to connect equipment or the grounded circuit of a wiring system to a grounding electrode or electrodes.

Grounding conductor, equipment – The conductor used to connect the noncurrent-carrying metal parts of equipment, raceways, and other enclosures to the system grounded conductor and/or the grounding electrode conductor at the service equipment, or at the source of a separately derived system.

Grounding electrode conductor – The conductor used to connect the grounding electrode to the equipment grounding conductor and/or to the grounded conductor of the circuit at the service equipment or at the source of a separately derived system.

Ground fault circuit interrupter – A device whose function is to interrupt the electric circuit to the load when a fault current to ground exceeds some predetermined value that is less than that required to operate the overcurrent protective device of the supply circuit.

Guarded – Covered, shielded, fenced, enclosed, or otherwise protected by means of suitable covers, casings, barriers, rails, screens, mats, or platforms to remove the likelihood of approach to a point of danger or contact by persons or objects.

Health care facilities – Buildings or portions of buildings and mobile homes that contain, but are not limited to, hospitals, nursing homes, extended care facilities, clinics, and medical and dental offices, whether fixed or mobile.

Heating equipment – For the purposes of 1910.306(g), the term "heating equipment" includes any equipment used for heating purposes if heat is generated by induction or dielectric methods.

Hoistway – Any shaftway, hatchway, well hole, or other vertical opening or space in which an elevator or dumbwaiter is designed to operate.

Identified – Identified, as used in reference to a conductor or its terminal, means that such conductor or terminal can be readily recognized as grounded.

Induction heating – Induction heating is the heating of a nominally conductive material due to its own $I^2 R$ losses when the material is placed in a varying electromagnetic field.

Insulated conductor – See "Conductor."

Interrupter switch (Over 600 V, nominal) – A switch capable of making, carrying, and interrupting specified currents.

Irrigation machine – An irrigation machine is an electrically driven or controlled machine, with one or more motors, not hand portable, and used primarily to transport and distribute water for agricultural purposes.

Isolated – Not readily accessible to persons unless special means for access are used.

Isolated power system – A system comprising an isolating transformer, or its equivalent, a line isolation monitor, and its ungrounded circuit conductors.

Labeled – Equipment is "labeled" if there is attached to it a label, symbol, or other identifying mark of a nationally recognized testing laboratory which:

1. makes periodic inspections of the production of such equipment, and
2. whose labeling indicates compliance with nationally recognized standards or tests to determine safe use in a specified manner.

Lighting outlet – An outlet intended for the direct connection of a lampholder, a lighting fixture, or a pendant cord terminating in a lampholder.

Line-clearance tree trimming – The pruning, trimming, repairing, maintaining, removing, or clearing of trees or cutting of brush that is within 10 feet (305 cm) of electric supply lines and equipment.

Listed – Equipment is "listed" if it is of a kind mentioned in a list which:

1. is published by a nationally recognized laboratory which makes periodic inspection of the production of such equipment, and
2. states such equipment meets nationally recognized standards or has been tested and found safe for use in a specified manner.

Location –

1. *Damp location* – Partially protected locations under canopies, marquees, roofed open porches, and like locations, and interior locations subject to moderate degrees of moisture, such as some basements, some barns, and some cold-storage warehouses.
2. *Dry location* – A location not normally subject to dampness or wetness. A location classified as dry may be temporarily subject to dampness or wetness, as in the case of a building under construction.
3. *Wet location* – Installations underground or in concrete slabs or masonry in direct contact with the earth, and locations subject to saturation with water or other liquids, such as vehicle-washing areas, and locations exposed to weather and unprotected.

May – If a discretionary right, privilege, or power is abridged, or if an obligation to abstain from acting is imposed, the word "may" is used with a restrictive "no" "not," or "only." (e.g., no employer may...; an employer may not...; only qualified persons may...)

Medium voltage cable – Type MV medium voltage cable is a single or multiconductor solid dielectric insulated cable rated 2000 V or higher.

Metal-clad cable – Type MC cable is a factory assembly of one or more conductors, each individually insulated and enclosed in a metallic sheath of interlocking tape, or a smooth or corrugated tube.

Mineral-insulated metal-sheathed cable – Type MI mineral-insulated metal-sheathed cable is a factory assembly of one or more conductors insulated with a highly compressed refractory mineral insulation and enclosed in a liquid tight and gastight continuous copper sheath.

Mobile X-ray – X-ray equipment mounted on a permanent base with wheels and/or casters for moving while completely assembled.

Nonmetallic-sheathed cable – Nonmetallic-sheathed cable is a factory assembly of two or more insulated conductors having an outer sheath of moisture resistant, flame-retardant, nonmetallic material

Oil (filled) cutout (Over 600 V, nominal) – A cutout in which all or part of the fuse support and its fuse link or disconnecting blade are mounted in oil with complete immersion of the contacts and the fusible portion of the conducting element (fuse link), so that arc interruption by severing of the fuse link, or by opening of the contacts, will occur under oil.

Open wiring on insulators – Open wiring on insulators is an exposed wiring method using cleats, knobs, tubes, and flexible tubing for the protection and support of single insulated conductors run in or on buildings, and not concealed by the building structure.

Outlet – A point on the wiring system at which current is taken to supply utilization equipment.

Outline lighting – An arrangement of incandescent lamps or electric discharge tubing to outline or call attention to, certain features such as the shape of a building or the decoration of a window.

Oven, wall-mounted – An oven for cooking purposes designed for mounting in or on a wall or other surface and consisting of one or more heating elements, internal wiring, and built-in or separately mountable controls (see "Cooking unit, counter-mounted").

Overcurrent – Any current in excess of the rated current of equipment or the ampacity of a conductor. It may result from overload (see definition), short circuit, or ground fault. A current in excess of rating may be accommodated by certain equipment and conductors for a given set of conditions. Hence the rules for overcurrent protection are specific for particular situations.

Overload – Operation of equipment in excess of normal, full load rating, or of a conductor in excess of rated ampacity which, when it persists for a sufficient length of time, would cause damage or dangerous overheating. A fault, such as a short circuit or ground fault, is not an overload (see "Overcurrent").

Panelboard – A single panel or group of panel units: designed for assembly in the form of a single panel; including buses, automatic overcurrent devices, and with, or without, switches for the control of light, heat, or power circuits; designed to be placed in a cabinet or cutout box placed in or against a wall or partition and accessible only from the front (see "Switchboard").

Permanently installed decorative fountains and reflection pools – Those that are constructed in the ground, on the ground or in a building in such a manner that the pool cannot be readily

disassembled for storage and are served by electrical circuits of any nature. These units are primarily constructed for their aesthetic value and not intended for swimming or wading.

Permanently installed swimming pools, wading and therapeutic pools – Those that are constructed in the ground, on the ground, or in a building in such a manner that the pool cannot be readily disassembled for storage, whether or not served by electrical circuits of any nature.

Portable X-ray – X-ray equipment designed to be hand-carried.

Power and control tray cable – Type TC power and control tray cable is a factory assembly of two or more insulated conductors, with or without associated bare or covered grounding conductors under a nonmetallic sheath, approved for installation in cable trays, in raceways, or where supported by a messenger wire.

Power fuse (Over 600 V, nominal) – See "Fuse."

Power-limited tray cable – Type PLTC nonmetallic-sheathed power limited tray cable is a factory assembly of two or more insulated conductors under a nonmetallic jacket.

Power outlet – An enclosed assembly which may include receptacles, circuit breakers, fuseholders, fused switches, buses and watt-hour meter mounting means; intended to supply and control power to mobile homes, recreational vehicles or boats, or to serve as a means for distributing power required to operate mobile or temporarily installed equipment.

Premises wiring system – That interior and exterior wiring, including power, lighting, control, and signal circuit wiring together with all of its associated hardware, fittings, and wiring devices, both permanently and temporarily installed, which extends from the load end of the service drop, or load end of the service lateral conductors to the outlet(s). Such wiring does not include wiring internal to appliances, fixtures, motors, controllers, motor control centers, and similar equipment.

Qualified person – One familiar with the construction and operation of the equipment and the hazards involved.

NOTE 1: Whether an employee is considered to be a "qualified person" will depend upon various circumstances in the workplace. It is possible and, in fact, likely for an individual to be considered "qualified" with regard to certain equipment in the workplace, but "unqualified" as to other equipment (see 1910.332(b)(3) for training requirements that specifically apply to qualified persons).

NOTE 2: An employee who is undergoing on-the-job training and who, in the course of such training, has demonstrated an ability to perform duties safely at his or her level of training, and who is under the direct supervision of a qualified person, is considered to be a qualified person for the performance of those duties.

Raceway – A channel designed expressly for holding wires, cables, or busbars, with additional functions as permitted in this subpart. Raceways may be of metal or insulating material, and the term includes rigid metal conduit, rigid nonmetallic conduit, intermediate metal conduit, liquid tight flexible metal conduit, flexible metallic tubing, flexible metal conduit, electrical metallic tubing, under floor raceways, cellular concrete floor raceways, cellular metal floor raceways, surface raceways, wireways, and busways.

Readily accessible – Capable of being reached quickly for operation, renewal, or inspections, without requiring those to whom ready access is requisite to climb over or remove obstacles or to resort to portable ladders, chairs, etc. (see "Accessible").

Receptacle – A receptacle is a contact device installed at the outlet for the connection of a single attachment plug. A single receptacle is a single contact device with no other contact device on the same yoke. A multiple receptacle is a single device containing two or more receptacles.

Receptacle outlet – An outlet where one or more receptacles are installed.

Remote-control circuit – Any electric circuit that controls any other circuit through a relay or an equivalent device.

Sealable equipment – Equipment enclosed in a case or cabinet that is provided with a means of sealing or locking so that live parts cannot be made accessible without opening the enclosure. The equipment may or may not be operable without opening the enclosure.

Separately derived system – A premises wiring system whose power is derived from generator, transformer, or converter winding and has no direct electrical connection, including a solidly connected grounded circuit conductor, to supply conductors originating in another system.

Service – The conductors and equipment for delivering energy from the electricity supply system to the wiring system of the premises served.

Service cable – Service conductors made up in the form of a cable.

Service conductors – The supply conductors that extend from the street main or from transformers to the service equipment of the premises supplied.

Service drop – The overhead service conductors from the last pole or other aerial support to, and including, the splices, if any, connecting to the service entrance conductors at the building or other structure.

Service-entrance cable – Service entrance cable is a single conductor or multiconductor assembly provided with or without an overall covering, primarily used for services and of the following types:

1. *Type SE*, having a flame-retardant, moisture-resistant covering, but not required to have inherent protection against mechanical abuse.
2. *Type USE*, recognized for underground use, having a moisture-resistant covering, but not required to have a flame-retardant covering or inherent protection against mechanical abuse. Single-conductor cables having an insulation specifically approved for the purpose do not require an outer covering.

Service-entrance conductors, overhead system – The service conductors between the terminals of the service equipment and a point usually outside the building, clear of building walls, where joined by tap or splice to the service drop.

Service-entrance conductors, underground system – The service conductors between the terminals of the service equipment and the point of connection to the service lateral. Where service equipment is located outside the building walls, there may be no service-entrance conductors, or they may be entirely outside the building.

Service equipment – The necessary equipment, usually consisting of a circuit breaker or switch and fuses, and their accessories, located near the point of entrance of supply conductors to a building or other structure, or an otherwise defined area, and intended to constitute the main control and means of cutoff of the supply.

Service raceway – The raceway that encloses the service-entrance conductors.

Service point – The point of connection between the facilities of the serving utility and the premises wiring.

Shielded nonmetallic-sheathed cable – Type SNM, shielded nonmetallic-sheathed cable is a factory assembly of two or more insulated conductors in an extruded core of moisture-resistant, flame-resistant nonmetallic material, covered with an overlapping spiral metal tape and wire shield and jacketed with an extruded moisture-, flame-, oil-, corrosion-, fungus-, and sunlight-resistant nonmetallic material.

Show window – Any window used or designed to be used for the display of goods or advertising material, whether it is fully or partly enclosed or entirely open at the rear and whether or not it has a platform raised higher than the street floor level.

Sign – See "Electric Sign."

Signaling circuit – Any electric circuit that energizes signaling equipment.

Special permission – The written consent of the authority having jurisdiction.

Storable swimming or wading pool – A pool with a maximum dimension of 15 feet and a maximum wall height of 3 feet and is so constructed that it may be readily disassembled for storage and reassembled to its original integrity.

Switchboard – A large single panel, frame, or assembly of panels which have switches, buses, instruments, overcurrent and other protective devices mounted on the face or back or both. Switchboards are generally accessible from the rear, as well as from the front and are not intended to be installed in cabinets (see "Panelboard").

Switch –

1. *General-use switch* – A switch intended for use in general distribution and branch circuits. It is rated in amperes, and it is capable of interrupting its rated current at its rated voltage.
2. *General-use snap switch* – A form of general-use switch so constructed that it can be installed in flush device boxes or on outlet box covers, or otherwise used in conjunction with wiring systems recognized by this subpart.
3. *Isolating switch* – A switch intended for isolating an electric circuit from the source of power. It has no interrupting rating, and it is intended to be operated only after the circuit has been opened by some other means.

4. *Motor-circuit switch* – A switch, rated in horsepower, capable of interrupting the maximum operating overload current of a motor of the same horsepower rating as the switch at the rated voltage.

Switching devices (Over 600 V, nominal) – Devices designed to close and/or open one or more electric circuits. Included in this category are circuit breakers, cutouts, disconnecting (or isolating) switches, disconnecting means, interrupter switches, and oil (filled) cutouts.

Transportable X-ray – X-ray equipment installed in a vehicle or that may readily be disassembled for transport in a vehicle.

Utilization equipment – Utilization equipment means equipment which utilizes electric energy for mechanical, chemical, heating, lighting, or similar useful purpose.

Utilization system – A utilization system is a system which provides electric power and light for employee workplaces, and includes the premises wiring system and utilization equipment.

Ventilated – Provided with a means to permit circulation of air sufficient to remove an excess of heat, fumes, or vapors.

Volatile flammable liquid – A flammable liquid having a flash point below 38 degrees C (100 degrees F), or whose temperature is above its flash point.

Voltage (of a circuit) – The greatest root-mean-square (effective) difference of potential between any two conductors of the circuit concerned.

Voltage, nominal – A nominal value assigned to a circuit or system for the purpose of conveniently designating its voltage class (as 120/240, 480Y/277, 600, etc.). The actual voltage at which a circuit operates can vary from the nominal, within a range that permits satisfactory operation of equipment.

Voltage to ground – For grounded circuits, the voltage between the given conductor and that point or conductor of the circuit that is grounded; for ungrounded circuits, the greatest voltage between the given conductor and any other conductor of the circuit.

Watertight – So constructed that moisture will not enter the enclosure.

Weatherproof – So constructed or protected that exposure to the weather will not interfere with successful operation. Rainproof, raintight, or watertight equipment can fulfill the requirements for weatherproof where varying weather conditions other than wetness, such as snow, ice, dust, or temperature extremes, are not a factor.

Wet location – See "Location."

Wireways – Wireways are sheet-metal troughs with hinged or removable covers for housing and protecting electric wires and cable and in which conductors are laid in place after the wireway has been installed as a complete system.

DEFINITIONS APPLICABLE TO 29 CFR 1910.269

Affected employee – An employee whose job requires him or her to operate or use a machine or equipment on which servicing or maintenance is being performed under lockout or tagout, or

whose job requires him or her to work in an area in which such servicing or maintenance is being performed.

Attendant – An employee assigned to remain immediately outside the entrance to an enclosed or other space to render assistance, as needed, to employees inside the space.

Authorized employee – An employee who locks out or tags out machines or equipment in order to perform servicing or maintenance on that machine or equipment. An affected employee becomes an authorized employee when that employee's duties include performing servicing or maintenance covered under this section.

Automatic circuit recloser – A self-controlled device for interrupting and reclosing an alternating current circuit with a predetermined sequence of opening and reclosing followed by resetting, hold-closed, or lockout operation.

Barricade – A physical obstruction, such as tapes, cones, or A-frame type wood or metal structures, intended to provide a warning about and to limit access to a hazardous area.

Barrier – A physical obstruction which is intended to prevent contact with energized lines or equipment or to prevent unauthorized access to a work area.

Bond – The electrical interconnection of conductive parts designed to maintain a common electrical potential.

Bus – A conductor or a group of conductors that serve as a common connection for two or more circuits.

Bushing – An insulating structure, including a through conductor or providing a passageway for such a conductor, with provision for mounting on a barrier, conducting or otherwise, for the purposes of insulating the conductor from the barrier and conducting current from one side of the barrier to the other.

Cable – A conductor with insulation, or a stranded conductor with or without insulation and other coverings (single-conductor cable), or a combination of conductors insulated from one another (multiple-conductor cable).

Cable sheath – A conductive protective covering applied to cables.

NOTE: A cable sheath may consist of multiple layers of which one or more is conductive.

Circuit – A conductor or system of conductors through which an electric current is intended to flow.

Clearance (between objects) – The clear distance between two objects measured surface to surface.

Clearance (for work) – Authorization to perform specified work or permission to enter a restricted area.

Communication lines – See "Lines, communication."

Conductor – A material, usually in the form of a wire, cable, or bus bar, used for carrying an electric current.

Covered conductor – A conductor covered with a dielectric having no rated insulating strength or having a rated insulating strength less than the voltage of the circuit in which the conductor is used.

Current-carrying part – A conducting part intended to be connected in an electric circuit to a source of voltage. Noncurrent-carrying parts are those not intended to be so connected.

De-energized – Free from any electrical connection to a source of potential difference and from electric charge; not having a potential different from that of the earth.

NOTE: The term is used only with reference to current-carrying parts, which are sometimes energized (alive).

Designated employee (designated person) – An employee (or person) who is designated by the employer to perform specific duties under the terms of this section and who is knowledgeable in the construction and operation of the equipment and the hazards involved.

Electric line truck – A truck used to transport personnel, tools, and material for electric supply line work.

Electric supply equipment – Equipment that produces, modifies, regulates, controls, or safeguards a supply of electric energy.

Electric supply lines – See "Lines, electric supply."

Electric utility – An organization responsible for the installation, operation, or maintenance of an electric supply system.

Enclosed space – A working space, such as a manhole, vault, tunnel, or shaft, that has a limited means of egress or entry, that is designed for periodic employee entry under normal operating conditions, and that, under normal conditions, does not contain a hazardous atmosphere, but that may contain a hazardous atmosphere under abnormal conditions.

NOTE: Spaces that are enclosed but not designed for employee entry under normal operating conditions are not considered to be enclosed spaces for the purposes of this section. Similarly, spaces that are enclosed and that are expected to contain a hazardous atmosphere are not considered to be enclosed spaces for the purposes of this section. Such spaces meet the definition of permit spaces in § 1910.146 of this Part, and entry into them must be performed in accordance with that standard.

Energized (alive, live) – Electrically connected to a source of potential difference, or electrically charged so as to have a potential significantly different from that of earth in the vicinity.

Energy isolating device – A physical device that prevents the transmission or release of energy, including, but not limited to, the following: a manually operated electric circuit breaker, a disconnect switch, a manually operated switch, a slide gate, a slip blind, a line valve, blocks, and any similar device with a visible indication of the position of the device. (Push buttons, selector switches, and other control-circuit-type devices are not energy isolating devices.)

Energy, source – Any electrical, mechanical, hydraulic, pneumatic, chemical, nuclear, thermal, or other energy source that could cause injury to personnel.

Equipment (electric) – A general term including material, fittings, devices, appliances, fixtures, apparatus, and the like used as part of Orin connection with an electrical installation.

Exposed – Not isolated or guarded.

Ground – A conducting connection, whether intentional or accidental, between an electric circuit or equipment and the earth, or to some conducting body that serves in place of the earth.

Grounded – Connected to earth or to some conducting body that serves in place of the earth.

Guarded – Covered, fenced, enclosed, or otherwise protected, by means of suitable covers or casings, barrier rails or screens, mats, or platforms, designed to minimize the possibility, under normal conditions, of dangerous approach or accidental contact by persons or objects.

NOTE: Wires which are insulated, but not otherwise protected, are not considered as guarded.

Hazardous Atmosphere - means an atmosphere that may expose employees to the risk of death, incapacitation, impairment of ability to self rescue (that is, escape unaided from an enclosed space), injury, or acute illness from one or more of the following causes:

1. *Flammable gas, vapor, or mist in excess of 10% of its lower flammable limit (LFL);*
2. *Airborne combustible dust at a concentration that meets or exceeds its LFL;*

NOTE: This concentration may be approximated as a condition in which the dust obscures vision at a distance of 5 feet (1.52 m) or less.

3. *Atmospheric oxygen concentration below 19.5% or above 23.5%;*
4. *Atmospheric concentration of any substance for which a dose or a permissible exposure limit is published in Subpart G, Occupational Health and Environmental Control, or in Subpart Z, Toxic and Hazardous Substances, of this Part and which could result in employee exposure in excess of its dose or permissible exposure limit;*
or

NOTE: An atmospheric concentration of any substance that is not capable of causing death, incapacitation, impairment of ability to self-rescue, injury, or acute illness due to its health effects, is not covered by this provision.

5. *Any other atmospheric condition that is immediately dangerous to life or health.*

NOTE: For air contaminants for which OSHA has not determined a dose or permissible exposure limit, other sources of information, such as Material Safety Data Sheets that comply with the Hazard Communication Standard, § 1910.1200 of this Part, published information, and internal documents can provide guidance in establishing acceptable atmospheric conditions.

High-power tests – Tests in which fault currents, load currents, magnetizing currents, and line-dropping currents are used to test equipment, either at the equipment's rated voltage, or at lower voltages.

High-voltage tests – Tests in which voltages of approximately 1000 V are used as a practical minimum and in which the voltage source has sufficient energy to cause injury.

High wind – A wind of such velocity that the following hazards would be present:

1. *An employee would be exposed to being blown from elevated locations, or*
2. *An employee or material handling equipment could lose control of material being handled, or*
3. *An employee would be exposed to other hazards not controlled by the standard involved.*

NOTE 1: Winds exceeding 40 miles per hour (64.4 kilometers per hour), or 30 miles per hour (48.3 kilometers per hour) if material handling is involved, are normally considered as meeting this criteria unless precautions are taken to protect employees from the hazardous effects of the wind. Immediately dangerous to life or health (IDLH) means any condition that poses an immediate or delayed threat to life or that would cause irreversible adverse health effects or that would interfere with an individual's ability to escape unaided from a permit space.

NOTE 2: Some materials – hydrogen fluoride gas and cadmium vapor, for example – may produce immediate transient effects that, even if severe, may pass without medical attention, but are followed by sudden, possibly fatal collapse 12-72 hours after exposure. The victim "feels normal" from recovery from transient effects until collapse. Such materials in hazardous quantities are considered to be "immediately" dangerous to life or health.

Insulated – Separated from other conducting surfaces by a dielectric (including air space) offering a high resistance to the passage of current.

NOTE: When any object is said to be insulated, it is understood to be insulated for the conditions to which it is normally subjected. Otherwise, it is, within the purpose of this section, uninsulated.

Insulation (cable) – That which is relied upon to insulate the conductor from other conductors or conducting parts or from ground.

Line-clearance tree trimmer – An employee who, through related training or on-the-job experience, or both, is familiar with the special techniques and hazards involved in line-clearance tree trimming.

NOTE 1: An employee who is regularly assigned to a line-clearance tree-trimming crew and who is undergoing on-the-job training and who, in the course of such training, has demonstrated an ability to perform duties safely at his or her level of training and who is under the direct supervision of a line-clearance tree trimmer is considered to be a line-clearance tree trimmer for the performance of those duties.

NOTE 2: A line-clearance tree trimmer is not considered to be a "qualified employee" under this section unless he or she has the training required for a qualified employee under paragraph (a)(2)(ii) of this section. However, under the electrical safety-related work practices standard in Subpart S of this Part, a line-clearance tree trimmer is considered to be a "qualified employee." Tree trimming performed by such "qualified employees" is not subject to the electrical safety-related work practice requirements contained in § 1910.331 through § 1910.335 of this Part. (See also the note following

§1910.332(b)(3) of this Part for information regarding the training an employee must have to be considered a qualified employee under § 1910.331 through § 1910.335 of this part.)

Line-clearance tree trimming – The pruning, trimming, repairing, maintaining, removing, or clearing of trees or the cutting of brush that is within 10 feet (305 cm) of electric supply lines and equipment.

Lines –

1. *Communication lines* – The conductors and their supporting or containing structures which are used for public or private signal or communication service, and which operate at potentials not exceeding 400 V to ground or 750 V between any two points of the circuit, and the transmitted power of which does not exceed 150 watts. If the lines are operating at less than 150 V, no limit is placed on the transmitted power of the system. Under certain conditions, communication cables may include communication circuits exceeding these limitations where such circuits are also used to supply power solely to communication equipment.

NOTE: Telephone, telegraph, railroad signal, data, clock, fire, police alarm, cable television, and other systems conforming to this definition are included. Lines used for signaling purposes, but not included under this definition, are considered as electric supply lines of the same voltage.

2. *Electric supply lines* – Conductors used to transmit electric energy and their necessary supporting or containing structures. Signal lines of more than 400 V are always supply lines within this section, and those of less than 400 V are considered as supply lines, if so run and operated throughout.

Manhole – A subsurface enclosure which personnel may enter and which is used for the purpose of installing, operating, and maintaining submersible equipment or cable.

Manhole steps – A series of steps individually attached to or set into the walls of a manhole structure.

Minimum approach distance – The closest distance an employee is permitted to approach an energized or a grounded object.

Qualified employee (qualified person) – One knowledgeable in the construction and operation of the electric power generation, transmission, and distribution equipment involved, along with the associated hazards.

NOTE 1: An employee must have the training required by paragraph (a)(2)(ii) of this section in order to be considered a qualified employee.

NOTE 2: Except under paragraph (g)(2)(v) of this section, an employee who is undergoing on-the-job training and who, in the course of such training, has demonstrated an ability to perform duties safely at his or her level of training, and who is under the direct supervision of a qualified person is considered to be a qualified person for the performance of those duties.

Step bolt – A bolt or rung attached at intervals along a structural member and used for foot placement during climbing or standing.

Switch – A device for opening and closing or for changing the connection of a circuit. In this section, a switch is understood to be manually operable, unless otherwise stated.

System operator – A qualified person designated to operate the system or its parts.

Vault – An enclosure, above or below ground, which personnel may enter and which is used for the purpose of installing, operating, or maintaining equipment or cable.

Vented vault – A vault that has provision for air changes using exhaust flue stacks and low-level air intakes, operating on differentials of pressure and temperature providing for airflow, which precludes a hazardous atmosphere from developing.

Voltage – The effective (rms) potential difference between any two conductors or between a conductor and ground. Voltages are expressed in nominal values unless otherwise indicated. The nominal voltage of a system or circuit is the value assigned to a system or circuit of a given voltage class for the purpose of convenient designation. The operating voltage of the system may vary above or below this value.

DEFINITIONS APPLICABLE TO 29 CFR 1926, SUBPART K

Acceptable – An installation or equipment is acceptable to the Assistant Secretary of Labor, and approved within the meaning of this Subpart K:

1. If it is accepted, or certified, or listed, or labeled, or otherwise determined to be safe by a qualified testing laboratory capable of determining the suitability of materials and equipment for installation and use in accordance with this standard; or
2. With respect to an installation or equipment of a kind which no qualified testing laboratory accepts, certifies, lists, labels, or determines to be safe, if it is inspected or tested by another Federal agency, or by a State, municipal, or other local authority responsible for enforcing occupational safety provisions of the National Electrical Code, and found in compliance with those provisions; or
3. With respect to custom-made equipment or related installations which are designed, fabricated for, and intended for use by a particular customer, if it is determined to be safe for its intended use by its manufacturer on the basis of test data which the employer keeps and makes available for inspection to the Assistant Secretary and his authorized representatives.

Accepted – An installation is "accepted" if it has been inspected and found to be safe by a qualified testing laboratory.

Accessible (As applied to wiring methods) – Capable of being removed or exposed without damaging the building structure or finish, or not permanently closed in by the structure or finish of the building (see "concealed" and "exposed").

Accessible (As applied to equipment) – Admitting close approach; not guarded by locked doors, elevation, or other effective means (see "Readily accessible").

Ampacity – The current in amperes a conductor can carry continuously under the conditions of use without exceeding its temperature rating.

Appliances – Utilization equipment, generally other than industrial, normally built in standardized sizes or types, which is installed or connected as a unit to perform one or more functions.

Approved – Acceptable to the authority enforcing this Subpart. The authority enforcing this Subpart is the Assistant Secretary of Labor for Occupational Safety and Health. The definition of "acceptable" indicates what is acceptable to the Assistant Secretary of Labor, and therefore approved within the meaning of this Subpart.

Askarel – A generic term for a group of nonflammable synthetic chlorinated hydrocarbons used as electrical insulating media. Askarels of various compositional types are used. Under arcing conditions the gases produced, while consisting predominantly of noncombustible hydrogen chloride, can include varying amounts of combustible gases depending upon the askarel type.

Attachment plug (Plug cap) (Cap) – A device which, by insertion in a receptacle, establishes connection between the conductors of the attached flexible cord and the conductors connected permanently to the receptacle.

Automatic – Self-acting, operating by its own mechanism when actuated by some impersonal influence, as for example, a change in current strength, pressure, temperature, or mechanical configuration.

Bare conductor – See "Conductor."

Bonding – The permanent joining of metallic parts to form an electrically conductive path which will assure electrical continuity and the capacity to conduct safely any current likely to be imposed.

Bonding jumper – A reliable conductor to assure the required electrical conductivity between metal parts required to be electrically connected.

Branch circuit – The circuit conductors between the final overcurrent device protecting the circuit and the outlet(s).

Building – A structure which stands alone or which is cut off from adjoining structures by fire walls with all openings therein protected by approved fire doors.

Cabinet – An enclosure designed either for surface or flush mounting, and provided with a frame, mat, or trim in which a swinging door or doors are or may be hung.

Certified – Equipment is "certified" if it:

- a. Has been tested and found by a qualified testing laboratory to meet applicable test standards or to be safe for use in a specified manner.
- b. Is of a kind whose production is periodically inspected by a qualified testing laboratory. Certified equipment must bear a label, tag, or other record of certification.

Circuit breaker –

- a. (600 V nominal, or less.) – A device designed to open and close a circuit by non-automatic means and to open the circuit automatically on a predetermined overcurrent without injury to itself when properly applied within its rating.

- b. (Over 600 V, nominal.) – A switching device capable of making, carrying, and breaking currents under normal circuit conditions, and also making, carrying for a specified time, and breaking currents under specified abnormal circuit conditions, such as those of short circuit.

Class I locations – Class I locations are those in which flammable gases or vapors are, or may be, present, in the air in quantities sufficient to produce explosive or ignitable mixtures. Class I locations include the following:

- a. *Class I, Division 1* – A Class 1, Division 1 location is a location:
 - 1. In which ignitable concentrations of flammable gases or vapors may exist under normal operating conditions; or
 - 2. In which ignitable concentrations of such gases or vapors may exist frequently because of repair or maintenance operations or because of leakage; or
 - 3. In which breakdown or faulty operation of equipment or processes might release ignitable concentrations of flammable gases or vapors, and might also cause simultaneous failure of electric equipment.

NOTE: This classification usually includes locations: where volatile flammable liquids or liquefied flammable gases are transferred from one container to another; interiors of spray booths and areas in the vicinity of spraying and painting operations where volatile flammable solvents are used; locations containing open tanks or vats of volatile flammable liquids; drying rooms or compartments for the evaporation of flammable solvents; inadequately ventilated pump rooms for flammable gas or for volatile flammable liquids; and, all other locations where ignitable concentrations of flammable vapors or gases are likely to occur in the course of normal operations.

- b. *Class I, Division 2* – A Class 1, Division 2 location is a location:
 - 1. In which volatile flammable liquids or flammable gases are handled, processed, or used, but in which the hazardous liquids, vapors, or gases will normally be confined within closed containers or closed systems from which they can escape only in case of accidental rupture or breakdown of such containers or systems, or in case of abnormal operation of equipment; or
 - 2. In which ignitable concentrations of gases or vapors are normally prevented by positive mechanical ventilation, and which might become hazardous through failure or abnormal operations of the ventilating equipment; or
 - 3. That is adjacent to a Class 1, Division 1 location, and to which ignitable concentrations of gases or vapors might occasionally be communicated unless such communication is prevented by adequate positive pressure ventilation from a source of clean air, and effective safeguards against ventilation failure are provided.

NOTE: This classification usually includes locations where volatile flammable liquids or flammable gases or vapors are used, but which would become hazardous only in case of an accident or of some unusual operating condition. The quantity of flammable material that might escape in case of accident, the adequacy of ventilating equipment, the total area involved, and the record of the industry or business with respect to explosions or fires are all factors that merit consideration in determining the classification and extent of each location. Piping without valves, checks, meters, and similar devices would not ordinarily introduce a hazardous condition even though used

for flammable liquids or gases. Locations used for the storage of flammable liquids or of liquefied or compressed gases in sealed containers would not normally be considered hazardous unless also subject to other hazardous conditions. Electrical conduits and their associated enclosures separated from process fluids by a single seal or barrier are classed as a Division 2, location, if the outside of the conduit and enclosures is a nonhazardous location.

Class II locations – Class II locations are those that are hazardous because of the presence of combustible dust. Class II locations include the following:

- a. *Class II, Division 1* – A Class II, Division 1 location is a location:
1. In which combustible dust is or may be in suspension in the air under normal operating conditions, in quantities sufficient to produce explosive or ignitable mixtures; or
 2. Where mechanical failure or abnormal operation of machinery or equipment might cause such explosive or ignitable mixtures to be produced, and might also provide a source of ignition through simultaneous failure of electric equipment, operation of protection devices, or from other causes; or
 3. In which combustible dusts of an electrically conductive nature may be present.

NOTE: Combustible dusts which are electrically non-conductive include dusts produced in the handling and processing of grain and grain products, pulverized sugar and cocoa, dried egg and milk powders, pulverized spices, starch and pastes, potato and wood flour, oil meal from beans and seed, dried hay, and other organic materials which may produce combustible dusts when processed or handled. Dusts containing magnesium or aluminum are particularly hazardous and the use of extreme caution is necessary to avoid ignition and explosion.

- b. *Class II, Division 2* – A Class II, Division 2 location is a location in which:
1. Combustible dust will not normally be in suspension in the air in quantities sufficient to produce explosive or ignitable mixtures, and dust accumulations are normally insufficient to interfere with the normal operation of electrical equipment or other apparatus; or
 2. Dust may be in suspension in the air as a result of infrequent malfunctioning of handling or processing equipment, and dust accumulations resulting there from may be ignitable by abnormal operation or failure of electrical equipment or other apparatus.

NOTE: This classification includes locations where dangerous concentrations of suspended dust would not be likely, but where dust accumulations might form on, or in the vicinity of, electric equipment. These areas may contain equipment from which appreciable quantities of dust would escape under abnormal operating conditions or be adjacent to a Class II Division 1 location, as described above, into which an explosive or ignitable concentration of dust may be put into suspension under abnormal operating conditions.

Class III locations – Class III locations are those that are hazardous because of the presence of easily ignitable fibers or flyings but in which such fibers or flyings are not likely to be in suspension in the air in quantities sufficient to produce ignitable mixtures. Class III locations include the following:

- a. *Class III, Division 1* – A Class III, Division 1 location is a location in which easily ignitable fibers or materials producing combustible flyings are handled, manufactured, or used.

NOTE: Easily ignitable fibers and flyings include rayon, cotton (including cotton linters and cotton waste), sisal or henequen, istle, jute, hemp, tow, cocoa fiber, oakum, baled waste kapok, Spanish moss, excelsior, sawdust, woodchips, and other material of similar nature.

- b. *Class III, Division 2* – A Class 111, Division 2 location is a location in which easily ignitable fibers are stored or handled, except in process of manufacture.

Collector ring – A collector ring is an assembly of slip rings for transferring electrical energy from a stationary to a rotating member.

Concealed – Rendered inaccessible by the structure or finish of the building. Wires in concealed raceways are considered concealed, even though they may become accessible by withdrawing them. [See "Accessible. (As applied to wiring methods.)"]

Conductor –

- a. Bare – A conductor having no covering or electrical insulation whatsoever.
- b. Covered – A conductor encased within material of composition or thickness that is not recognized as electrical insulation.
- c. Insulated – A conductor encased within material of composition and thickness that is recognized as electrical insulation.

Controller – A device, or group of devices, that serves to govern, in some predetermined manner, the electric power delivered to the apparatus to which it is connected.

Covered conductor – See "Conductor."

Cutout – (Over 600 V, nominal.) An assembly of a fuse support with either a fuseholder, fuse carrier, or disconnecting blade. The fuseholder or fuse carrier may include a conducting element (fuse link), or may act as the disconnecting blade by the inclusion of a nonfusible member.

Cutout box – An enclosure designed for surface mounting and having swinging doors or covers secured directly to and telescoping with the walls of the box proper (see "Cabinet").

Damp location – See "Location."

Dead front – Without live parts exposed to a person on the operating side of the equipment.

Device – A unit of an electrical system which is intended to carry but not utilize electric energy.

Disconnecting means – A device, or group of devices, or other means by which the conductors of a circuit can be disconnected from their source of supply.

Disconnecting (or Isolating) switch – (Over 600 V, nominal.) A mechanical switching device used for isolating a circuit or equipment from a source of power.

Dry location – See "Location."

Enclosed – Surrounded by a case, housing, fence or walls which will prevent persons from accidentally contacting energized parts.

Enclosure – The case or housing of apparatus, or the fence or walls surrounding an installation to prevent personnel from accidentally contacting energized parts, or to protect the equipment from physical damage.

Equipment – A general term including material, fittings, devices, appliances, fixtures, apparatus, and the like, used as a part of, or in connection with, an electrical installation.

Equipment grounding conductor – See "Grounding conductor, equipment."

Explosion-proof apparatus – Apparatus enclosed in a case that: is capable of withstanding an explosion of a specified gas or vapor which may occur within it and of preventing the ignition of a specified gas or vapor surrounding the enclosure by sparks, flashes, or explosion of the gas or vapor within, and which operates at such an external temperature that it will not ignite a surrounding flammable atmosphere.

Exposed (As applied to live parts) – Capable of being inadvertently touched or approached nearer than a safe distance by a person. It is applied to parts not suitably guarded, isolated, or insulated (see "Accessible" and "Concealed").

Exposed (As applied to wiring methods.)– On or attached to the surface or behind panels designed to allow access [see "Accessible. (As applied to wiring methods)"]

Exposed (For the purposes of 1926.408(d), Communications systems) – Where the circuit is in such a position that, in case of failure of supports or insulation, contact with another circuit may result.

Externally operable – Capable of being operated without exposing the operator to contact with live parts.

Feeder – All circuit conductors between the service equipment, or the generator switchboard of an isolated plant, and the final branch circuit overcurrent device.

Festoon lighting – A string of outdoor lights suspended between two points more than 15 feet (4.57 m) apart.

Fitting – An accessory such as a locknut, bushing, or other part of a wiring system that is intended primarily to perform a mechanical rather than an electrical function.

Fuse (Over 600 V, nominal) – An overcurrent protective device with a circuit opening fusible part that is heated and severed by the passage of overcurrent through it. A fuse comprises all the parts that form a unit capable of performing the prescribed functions. It may or may not be the complete device necessary to connect it into an electrical circuit.

Ground – A conducting connection, whether intentional or accidental, between an electrical circuit or equipment and the earth, or to some conducting body that serves in place of the earth.

Grounded – Connected to earth or to some conducting body that serves in place of the earth.

Grounded, effectively (Over 600 V, nominal.) – Permanently connected to earth through a ground connection of sufficiently low impedance and having sufficient ampacity that ground fault current which may occur cannot build up to voltages dangerous to personnel.

Grounded conductor – A system or circuit conductor that is intentionally grounded.

Grounding conductor – A conductor used to connect equipment or the grounded circuit of a wiring system to a grounding electrode or electrodes.

Grounding conductor, equipment – The conductor used to connect the noncurrent—carrying metal parts of equipment, raceways, and other enclosures to the system grounded conductor and/or the grounding electrode conductor at the service equipment, or at the source of a separately derived system.

Grounding electrode conductor – The conductor used to connect the grounding electrode to the equipment grounding conductor and/or to the grounded conductor of the circuit at the service equipment or at the source of a separately derived system.

Ground fault circuit interrupter – A device for the protection of personnel that functions to de-energize a circuit, or portion thereof, within an established period of time when a current-to-ground exceeds some predetermined value that is less than that required to operate the overcurrent protective device of the supply circuit.

Guarded – Covered, shielded, fenced, enclosed, or otherwise protected by means of suitable covers, casings, barriers, rails, screens, mats, or platforms to remove the likelihood of approach to a point of danger or contact by persons or objects.

Hoistway – Any shaftway, hatchway, well hole, or other vertical opening or space in which an elevator or dumbwaiter is designed to operate.

Identified (conductors or terminals) – Identified, as used in reference to a conductor or its terminal, means that such conductor or terminal can be recognized as grounded.

Identified (for the use) – Recognized as suitable for the specific purpose, function, use, environment, application, etc. where described as a requirement in this standard. Suitability of equipment for a specific purpose, environment, or application is determined by a qualified testing laboratory where such identification includes labeling or listing.

Insulated conductor – See "Conductor."

Interrupter switch (Over 600 V, nominal) – A switch capable of making, carrying, and interrupting specified currents.

Intrinsically safe equipment and associated wiring – Equipment and associated wiring in which any spark or thermal effect, produced either normally or in specified fault conditions, is incapable, under certain prescribed test conditions, of causing ignition of a mixture of flammable or combustible material in air in its most easily ignitable concentration.

Isolated – Not readily accessible to persons unless special means for access are used.

Isolated power system – A system comprising an isolating transformer or its equivalent, a line isolation monitor, and its ungrounded circuit conductors.

Labeled – Equipment or materials to which has been attached a label, symbol or other identifying mark of a qualified testing laboratory, which indicates compliance with appropriate standards or performance in a specified manner.

Lighting outlet – An outlet intended for the direct connection of a lampholder, a lighting fixture, or a pendant cord terminating in a lampholder.

Listed – Equipment or materials included in a list published by a qualified testing laboratory whose listing states either that the equipment or material meets appropriate standards or has been tested and found suitable for use in a specified manner.

Location –

- a. Damp location – Partially protected locations under canopies, marquees, roofed open porches, and like locations, and interior locations subject to moderate degrees of moisture, such as some basements.
- b. Dry location – A location not normally subject to dampness or wetness. A location classified as dry may be temporarily subject to dampness or wetness, as in the case of a building under construction.
- c. Wet location – Installations underground or in concrete slabs or masonry in direct contact with the earth, and locations subject to saturation with water or other liquids, such as locations exposed to weather and unprotected.

Mobile X-ray – X-ray equipment mounted on a permanent base with wheels and/or casters for moving while completely assembled.

Motor control center – An assembly of one or more enclosed sections having a common power bus and principally containing motor control units.

Outlet – A point on the wiring system at which current is taken to supply utilization equipment.

Overcurrent – Any current in excess of the rated current of equipment or the ampacity of a conductor. It may result from overload (see definition), short circuit, or ground fault. A current in excess of rating may be accommodated by certain equipment and conductors for a given set of conditions. Hence the rules for overcurrent protection are specific for particular situations.

Overload – Operation of equipment in excess of normal, full load rating, or of a conductor in excess of rated ampacity which, when it persists for a sufficient length of time, would cause damage or dangerous overheating. A fault, such as a short circuit or ground fault, is not an overload (see "Overcurrent").

Panelboard – A single panel or group of panel units designed for assembly in the form of a single panel; including buses, automatic overcurrent devices, and with or without switches for the control of light, heat, or power circuits; designed to be placed in a cabinet or cutout box placed in or against a wall or partition and accessible only from the front (see "Switchboard").

Portable X-ray – X-ray equipment designed to be hand carried.

Power fuse (Over 600 V, nominal) – See "Fuse."

Power outlet – An enclosed assembly which may include receptacles, circuit breakers, fuseholders, fused switches, buses and watt-hour meter mounting means; intended to serve as a means for distributing power required to operate mobile or temporarily installed equipment.

Premises wiring system – That interior and exterior wiring, including power, lighting, control, and signal circuit wiring together with all of its associated hardware, fittings, and wiring devices, both permanently and temporarily installed, which extends from the load end of the service drop, or load end of the service lateral conductors to the outlet(s). Such wiring does not include wiring internal to appliances, fixtures, motors, controllers, motor control centers, and similar equipment.

Qualified person – One familiar with the construction and operation of the equipment and the hazards involved.

Qualified testing laboratory – A properly equipped and staffed testing laboratory which has capabilities for and which provides the following services:

- a. Experimental testing for safety of specified items of equipment and materials referred to in this standard to determine compliance with appropriate test standards or performance in a specified manner;
- b. Inspecting the run of such items of equipment and materials at factories for product evaluation to assure compliance with the test standards;
- c. Service-value determinations through field inspections to monitor the proper use of labels on products and with authority for recall of the label in the event a hazardous product is installed;
- d. Employing a controlled procedure for identifying the listed and/or labeled equipment or materials tested; and
- e. Rendering creditable reports or findings that are objective and without bias of the tests and test methods employed.

Raceway – A channel designed expressly for holding wires, cables, or busbars, with additional functions as permitted in this subpart. Raceways may be of metal or insulating material, and the term includes rigid metal conduit, rigid nonmetallic conduit, intermediate metal conduit, liquid tight flexible metal conduit, flexible metallic tubing, flexible metal conduit, electrical metallic tubing, under floor raceways, cellular concrete floor raceways, cellular metal floor raceways, surface raceways, wireways, and busways.

Readily accessible – Capable of being reached quickly for operation, renewal, or inspections, without requiring those to whom ready access is requisite to climb over or remove obstacles or to resort to portable ladders, chairs, etc. (See "Accessible.")

Receptacle – A receptacle is a contact device installed at the outlet for the connection of a single attachment plug. A single receptacle is a single contact device with no other contact device on the same yoke. A multiple receptacle is a single device containing two or more receptacles.

Receptacle outlet – An outlet where one or more receptacles are installed.

Remote-control circuit – Any electric circuit that controls any other circuit through a relay or an equivalent device.

Sealable equipment – Equipment enclosed in a case or cabinet that is provided with a means of sealing or locking so that live parts cannot be made accessible without opening the enclosure. The equipment may or may not be operable without opening the enclosure.

Separately derived system – A premises wiring system whose power is derived from generator, transformer, or converter windings and has no direct electrical connection, including a solidly connected grounded circuit conductor, to supply conductors originating in another system.

Service – The conductors and equipment for delivering energy from the electricity supply system to the wiring system of the premises served.

Service conductors – The supply conductors that extend from the street main or from transformers to the service equipment of the premises supplied.

Service drop – The overhead service conductors from the last pole or other aerial support to, and including, the splices, if any, connecting to the service-entrance conductors at the building or other structure.

Service-entrance conductors, overhead system – The service conductors between the terminals of the service equipment and a point usually outside the building, clear of building walls, where joined by tap or splice to the service drop.

Service-entrance conductors, underground system – The service conductors between the terminals of the service equipment and the point of connection to the service lateral. Where service equipment is located outside the building walls, there may be no service-entrance conductors, or they may be entirely outside the building.

Service equipment – The necessary equipment, usually consisting of a circuit breaker or switch and fuses, and their accessories, located near the point of entrance of supply conductors to a building or other structure, or an otherwise defined area, and intended to constitute the main control and means of cutoff of the supply.

Service raceway – The raceway that encloses the service—entrance conductors.

Signaling circuit – Any electric circuit that energizes signaling equipment.

Switchboard – A large single panel, frame, or assembly of panels which have switches, buses, instruments, overcurrent and other protective devices mounted on the face or back or both. Switchboards are generally accessible from the rear, as well as from the front and are not intended to be installed in cabinets (see "Panelboard").

Switches –

- a. *General-use switch* – A switch intended for use in general distribution and branch circuits. It is rated in amperes, and it is capable of interrupting its rated current at its rated voltage.

- b. General-use snap switch – A form of general-use switch so constructed that it can be installed in flush device boxes or on outlet box covers, or otherwise used in conjunction with wiring systems recognized by this subpart.
- c. Isolating switch – A switch intended for isolating an electric circuit from the source of power. It has no interrupting rating, and it is intended to be operated only after the circuit has been opened by some other means.
- d. Motor-circuit switch – A switch, rated in horsepower, capable of interrupting the maximum operating overload current of a motor of the same horsepower rating as the switch at the rated voltage.

Switching devices (Over 600 V, nominal) – Devices designed to close and/or open one or more electric circuits. Included in this category are circuit breakers, cutouts, disconnecting (or isolating) switches, disconnecting means, and interrupter switches.

Transportable X-ray – X-ray equipment installed in a vehicle or that may readily be disassembled for transport in a vehicle.

Utilization equipment – Utilization equipment means equipment which utilizes electric energy for mechanical, chemical, heating, lighting, or similar useful purpose.

Utilization system – A utilization system is a system which provides electric power and light for employee workplaces, and includes the premises wiring system and utilization equipment.

Ventilated – Provided with a means to permit circulation of air sufficient to remove an excess of heat, fumes, or vapors.

Volatile flammable liquid – A flammable liquid having a flash point below 38°C (100°F) or whose temperature is above its flash point, or a Class 11 combustible liquid having a vapor pressure not exceeding 40 psia (276 kPa) at 38°C (100°F) whose temperature is above its flash point.

Voltage (Of a circuit) – The greatest root-mean-square (effective) difference of potential between any two conductors of the circuit concerned.

Voltage, nominal – A nominal value assigned to a circuit or system for the purpose of conveniently designating its voltage class (as 120/240, 480Y/277, 600, etc.). The actual voltage at which a circuit operates can vary from the nominal within a range that permits satisfactory operation of equipment.

Voltage to ground – For grounded circuits, the voltage between the given conductor and that point or conductor of the circuit that is grounded; for ungrounded circuits, the greatest voltage between the given conductor and any other conductor of the circuit.

Watertight – So constructed that moisture will not enter the enclosure.

Weatherproof – So constructed or protected that exposure to the weather will not interfere with successful operation. Rainproof, raintight, or watertight equipment can fulfill the requirements for weatherproof where varying weather conditions other than wetness, such as snow, ice, dust, or temperature extremes, are not a factor.

Wet location – See "Location."

DEFINITIONS APPLICABLE TO 29 CFR 1926 SUBPART V

Alive or live (energized) – The term means electrically connected to a source of potential difference, or electrically charged, so as to be potentially significantly different from that of the earth in the vicinity. The term "live" is sometimes used in place of the term "current-carrying," where the intent is clear, to avoid repetition of the longer term.

Automatic circuit recloser – The term means a self-controlled device for automatically interrupting and reclosing an alternating current circuit with a predetermined sequence of opening and reclosing followed by resetting, hold closed, or lockout operation.

Barricade – The term means a physical obstruction such as tapes, screens, or cones intended to warn and limit access to a hazardous area.

Barrier – The term means a physical obstruction which is intended to prevent contact with energized lines or equipment.

Bond – The term means an electrical connection from one conductive element to another for the purpose of minimizing potential differences or providing suitable conductivity for fault current or for mitigation of leakage current and electrolytic action.

Bushing – The term means an insulating structure including a through conductor, or providing a passageway for such a conductor, with provision for mounting on a barrier, conducting or otherwise, for the purpose of insulating the conductor from the barrier and conducting current from one side of the barrier to the other.

Cable – The term means a conductor with insulation, or a stranded conductor with or without insulation and other coverings (single-conductor cable) or a combination of conductors insulated from one another (multiple-conductor cable).

Cable sheath – The term means a protective covering applied to cables.

NOTE: A cable sheath may consist of multiple layers of which one or more is conductive.

Circuit – The term means a conductor or system of conductors through which an electric current is intended to flow.

Communication lines – The term means the conductors and their supporting or containing structures which are used for public or private signal or communication service, and which operate at potentials not exceeding 400 V to ground or 750 V between any two points of the circuit, and the transmitted power of which does not exceed 150 watts. When operating at less than 150 V, no limit is placed on the capacity of the system.

NOTE: Telephone, telegraph, railroad signal, data, clock, fire, police-alarm, community television antenna, and other systems conforming with the above are included. Lines used for signaling purposes, but not included under the above definition, are considered as supply lines of the same voltage and are to be so run.

Conductor – The term means a material, usually in the form of a wire, cable, or bus bar suitable for carrying an electric current.

Conductor, shielding – The term means an envelope which encloses the conductor of a cable and provides an equipotential surface in contact with the cable insulation.

Current-carrying part – The term means a conducting part intended to be connected in an electric circuit to a source of voltage. Noncurrent-carrying parts are those not intended to be so connected.

Dead (de-energized) – The term means free from any electrical connection to a source of potential difference and from electrical charges: Not having a potential difference from that of earth.

NOTE: The term is used only with reference to current—carrying parts which are sometimes alive (energized).

Designated employee – The term means a qualified person delegated to perform specific duties under the conditions existing.

Effectively grounded – The term means intentionally connected to earth through a ground connection or connections of sufficiently low impedance and having sufficient current-carrying capacity to prevent the buildup of voltages which may result in undue hazard to connected equipment or to persons.

Electric line trucks – The term means a truck used to transport men, tools, and material, and to serve as a traveling workshop for electric power line construction and maintenance work. It is sometimes equipped with a boom and auxiliary equipment for setting poles, digging holes, and elevating material or men.

Enclosed – The term means surrounded by a case, cage, or fence, which will protect the contained equipment and prevent accidental contact of a person with live parts.

Equipment – This is a general term which includes fittings, devices, appliances, fixtures, apparatus, and the like, used as part of, or in connection with, an electrical power transmission and distribution system, or communication systems.

Exposed – The term means not isolated or guarded.

Electric supply lines – The term means those conductors used to transmit electric energy and their necessary supporting or containing structures. Signal lines of more than 400 V to ground are always supply lines within the meaning of the rules, and those of less than 400 V to ground may be considered as supply lines, if so run and operated throughout.

Guarded – The term means protected by personnel, covered, fenced, or enclosed by means of suitable casings, barrier rails, screens, mats, platforms, or other suitable devices in accordance with standard barricading techniques designed to prevent dangerous approach or contact by persons or objects.

NOTE: Wires, which are insulated but not otherwise protected, are not considered as guarded.

Ground (reference) – The term means that conductive body, usually earth, to which an electric potential is referenced.

Ground (as a noun) – The term means a conductive connection whether intentional or accidental, by which an electric circuit or equipment is connected to reference ground.

Ground (as a verb) – The term means the connecting or establishment of a connection, whether by intention or accident of an electric circuit or equipment to reference ground.

Grounding electrode (ground electrode) – The term grounding electrode means a conductor embedded in the earth, used for maintaining ground potential on conductors connected to it, and for dissipating into the earth current conducted to it.

Grounding electrode resistance – The term means the resistance of the grounding electrode to earth.

Grounding electrode conductor (grounding conductor) – The term means a conductor used to connect equipment or the grounded circuit of a wiring system to a grounding electrode.

Grounded conductor – The term means a system or circuit conductor which is intentionally grounded.

Grounded system – The term means a system of conductors in which at least one conductor or point (usually the middle wire, or neutral point of transformer or generator windings) is intentionally grounded, either solidly or through a current limiting device (not a current interrupting device).

Hotline tools and ropes – The term means those tools and ropes which are especially designed for work on energized high voltage lines and equipment. Insulated aerial equipment especially designed for work on energized high voltage lines and equipment shall be considered hotline.

Insulated – The term means separated from other conducting surfaces by a dielectric substance (including air space) offering a high resistance to the passage of current.

NOTE: When any object is said to be insulated, it is understood to be insulated in a suitable manner for the conditions to which it is subjected. Otherwise, it is within the purpose of this subpart, uninsulated. Insulating covering of conductors is one means of making the conductor insulated.

Insulation (as applied to cable) – The term means that which is relied upon to insulate the conductor from other conductors or conducting parts or from ground.

Insulation, shielding – The term means an envelope which encloses the insulation of a cable and provides an equipotential surface in contact with cable insulation.

Isolated – The term means an object that is not readily accessible to persons unless special means of access are used.

Manhole – The term means a subsurface enclosure which personnel may enter and which is used for the purpose of installing, operating, and maintaining equipment and/or cable.

Pulling tension – The term means the longitudinal force exerted on a cable during installation.

Qualified person – The term means a person who, by reason of experience or training, is familiar with the operation to be performed and the hazards involved.

Switch – The term means a device for opening and closing or changing the connection of a circuit. In these rules, a switch is understood to be manually operable, unless otherwise stated.

Tag – The term means a system or method of identifying circuits, systems or equipment for the purpose of alerting persons that the circuit, system or equipment is being worked on.

Unstable material – The term means earth material, other than running, that, because of its nature or the influence of related conditions, cannot be depended upon to remain in place without extra support, such as would be furnished by a system of shoring.

Vault – The term means an enclosure above or below ground which personnel may enter and is used for the purpose of installing, operating, and/or maintaining equipment and/or cable.

Voltage – The term means the effective (rms) potential difference between any two conductors or between a conductor and ground. Voltages are expressed in nominal values. The nominal voltage of a system or circuit is the value assigned to a system or circuit of a given voltage class for the purpose of convenient designation. The operating voltage of the system may vary above or below this value.

Voltage of an effectively grounded circuit – The term means the voltage between any conductor and ground unless otherwise indicated.

Voltage of a circuit not effectively grounded – The term means the voltage between any two conductors. If one circuit is directly connected to and supplied from another circuit of higher voltage (as in the case of an autotransformer), both are considered as of the higher voltage, unless the circuit of lower voltage is effectively grounded, in which case its voltage is not determined by the circuit of higher voltage. Direct connection implies electric connection as distinguished from connection merely through electromagnetic or electrostatic induction.

DEFINITIONS APPLICABLE TO SECTIONS 1 THROUGH 12 OF THE DOE HANDBOOK FOR ELECTRICAL SAFETY, DOE-HDBK-1092-2013

Bay – One vertical 19-inch wide segment of a rack cabinet. Several bays can be joined together to form a large rack cabinet.

Code of record – The code in effect at the time of design or installation. Unless required to correct a known hazard or a major modification is being performed, installations in compliance with the code of record, do not need to be upgrade to a later edition of the code unless so stated in the code.

Controlled access – If the chassis are screwed into the rack cabinet. Doors having latches can be taken to mean the circuitry is controlled. Control of the access to the area in which the tester is located is also a means of control. In this case the area should be identified.

Electro-explosive device – An explosive device detonated by an integral electrical component upon application of a specified voltage/current pulse to that component.

Electromagnetic (EMR) field – Time varying distribution in some medium of electric and magnetic forces.

Electromagnetic radiation – Emission of electromagnetic energy from an electrical source in a portion of the radio frequency spectrum which may pose a threat to electro-explosive devices.

Emergency-shutdown pushbutton (E-stop) – A control device provided to automatically stop electrical energy to devices in the area during an emergency.

Failsafe – Built-in safety characteristics of a unit or system so that unit or system failure or a loss of control power will not result in an unsafe condition.

General access area – An area that does not present hazards to personnel while equipment and systems are functioning normally. These areas are accessible to all personnel.

Grounding hook – A device for making a temporary connection to discharge and ground the internal energy sources in hazardous electrical equipment. It consists of a bare copper rod shaped like a shepherd's hook at one end, an insulating handle, and a suitable bare flexible copper cable securely connected at the other end, and can be securely connected to an equipment or building ground.

Interlocked access areas – Areas in which the sources of power should be interlocked with the access doors because of the hazards the areas contain.

Leakage current – Refers to all currents, including capacitively coupled currents that may be conveyed between exposed surfaces of the equipment and ground or other exposed surfaces of the equipment.

Limited access areas – Areas that are kept locked and are accessible only to authorized personnel because of the hazards they contain.

Modulation – Change in normal characteristics of the recurring pattern in an electromagnetic field as a result of a secondary electrical signal having been combined with the electrical signal from which the field originates.

Personnel safety interlock system – One or more of the emergency shutdown systems or personnel access control systems or both.

Power density – Emitted power per unit crosssectional area normal to the direction of propagation of an electromagnetic wave from which results an electromagnetic field.

Rack cabinet – Any enclosure intended to house electrical equipment mounted to cabinet rails mounted within the cabinet. Most rack cabinets house chassis 19-inch wide. They are available in several heights.

Radio frequency – Non ionizing radiation generated in the portion of the frequency spectrum for electromagnetic energy between audio and ultraviolet.

Safety barrier – A safeguard installed to restrict personnel access to a hazardous area.

Safety coordinator – An individual who has the responsibility of the safety of the work that is to be performed and who is familiar with the hazards involved.

Safety interlock – An electrical or mechanical device that prevents operation of equipment or precludes access to hazardous areas, enclosures, or equipment.

Safety watch – A person whose specific duties are to observe the workers and operations being performed.

DOE-HDBK-1092-2013

Shall – Information cited is a requirement from a regulatory standard such as OSHA and relevant DOE Orders.

Should – Information cited is a guidance such as consensus standards.

Underground facility – A facility built below ground surface.

Wavelength – Distance between repetitions of a recurring pattern in an electrical signal or electromagnetic field.

APPENDIX C EXAMPLE PROGRAM FOR UNLISTED ELECTRICAL EQUIPMENT

Note: In this Appendix, "shall" refers to requirements of regulatory standards identified in the Code of Federal Regulations (CFR) in 10 CFR 851, *Worker Health and Safety Program*, that may or may not apply to a specific location (e.g. Southwestern Power Administration, Western Area Power Administration, Bonneville Power, etc.).

1.0 INTRODUCTION

The use of unlisted and unapproved electrical equipment that contains or produces hazardous energy shall^{C.1} be nationally recognized testing laboratory (NRTL) listed/labeled or approved by an authority having jurisdiction (AHJ) prior to use. Listed equipment that has been modified or is used outside its use defined by the listing or manufacturer's instructions shall^{C.2} also be approved by an AHJ prior to use.

Site management shall^{C.3}:

- Ensure that all employees working in areas they are responsible for use only AHJ-approved electrical equipment; and
- Ensure NRTL-listed equipment is purchased and utilized if available.

This Appendix provides an example program for examining and approving unlisted electrical equipment at Department of Energy (DOE) sites that could be acceptable to the AHJ depending on the Site AHJ.

Field evaluation and approval of unlisted electrical equipment applies to electrical equipment used by employees and employees of subcontractors or organizations. All unlisted or modified NRTL-listed electrical equipment requires field evaluation and approval prior to use. These requirements apply as follows:

- New equipment shall^{C.4} be approved by an AHJ before use.
- Equipment previously accepted as approved without field examination could be approved with the Site AHJ approval.
- Approvals of equipment previously approved under a previous program that did not meet the requirements of the Site AHJ program should be evaluated by the Site AHJ. Approvals in this category may include previously-approved equipment that has been modified, or is used outside of its original intent.

This Appendix provides standard criteria for evaluation, labeling, and documentation of unlisted electrical equipment. The Occupational Safety & Health Administration (OSHA) requires explicit approval of all electrical equipment in the workplace to ensure it is free from recognized hazards that are likely to cause death or serious physical harm to employees. To maintain electrical safety at DOE facilities, only electrical equipment that has been approved as safe for the intended use shall^{C.5} be utilized. Unlisted electrical equipment shall^{C.2} be examined for safety before use as required by the Code of Federal Regulations (CFR) in 29 CFR 1910, *Occupational Safety and Health Standards*, Section 303(b).

1.1 NRTL-LISTED EQUIPMENT

NRTL-listed equipment shall^{C.6} be purchased and utilized if available. For new or replacement equipment, a NRTL-listed product shall^{C.7} be purchased instead of an unlisted product if both

exist. All NRTL-listed equipment shall^{C.8} be used for its intended purpose in accordance with the manufacturer's instructions. Otherwise, the equipment shall^{C.7} be treated as unlisted and approved by the AHJ.

1.2 DEFINITIONS

Approved Equipment – Equipment acceptable to the AHJ consisting of: (1) NRTL-listed equipment being used in accordance with its listing or labeling for the manufacturer's intended purpose; or, (2) equipment that is inspected and approved by an electrical inspector as safe for its intended purpose.

Electrical Equipment – Equipment that uses electrical energy for electronic, electro-mechanical, or chemical operations; heating; lighting; or similar purposes. Electrical equipment includes equipment used in laboratory research and development (R&D) as well as utility, facility, and shop equipment.

Electrical Inspector – A qualified electrical inspector is one who has been determined by his/her AHJ, or designee, to have the skill, knowledge, and abilities to safely perform the work to which he/she is assigned. In addition, he/she shall^{C.9} have knowledge of the applicable electrical safety requirements, as well as demonstrated field experience in the design, installation, and/or operation of facility or R&D electrical systems. He/she also performs field evaluations, approves, labels and documents electrical equipment installations and work.

Facility Electrical Equipment – Electrical equipment that is considered an integral part of a facility or building and is generally not under direct control by R&D or office personnel. Examples include: building pumps; compressors; HVAC equipment; fixed general lighting fixtures that are permanently attached to the building structure; and facility power distribution equipment, such as transformers.

Field Evaluation – The process used for one-of-a-kind, limited production, used, or modified products that are not listed or labeled under a full listing and certification program. The process is completed at the point of manufacturing, interim points of distribution, in the evaluating company's facilities, or at the final installation site or a combination of the above.

In-House-Built Equipment – Electrical equipment designed and/or fabricated by employees of a facility, including employees of subcontractors, other research organizations, including universities, other laboratories, and other research institutions.

Low-Hazard Equipment – Class X.0, X.1 equipment that contains only negligible or low-hazards as defined in Appendix D of the DOE Handbook for Electrical Safety, (DOE-HDBK-1092-2013).

Modified Equipment – NRTL-listed, or approved electrical equipment that has been modified or is being used for a purpose other than intended by the manufacturer/builder. Modification means that a change has been made that affects the safety of the equipment or is not in accordance with the manufacturer's/builder's installation, use, or maintenance instructions.

Nationally Recognized Testing Laboratory (NRTL) – An organization (e.g., Underwriters Laboratory, or UL):

- That is recognized by OSHA in accordance with Appendix A of 29 CFR 1910.7;
- That tests for safety;

DOE-HDBK-1092-2013

- That lists, labels, or accepts equipment or materials that meet all of the criteria in 29 CFR 1910.7(b)(1)-(b)(4);
- That is concerned with the evaluation of products or services;
- That maintains periodic inspection of production of listed equipment or materials, or periodic evaluation of services; and
- Whose listing states that the equipment, material, or services either, meet appropriate designated standards or have been tested and found suitable for a specified purpose.

NRTL-Listed Equipment – Equipment, included in a list published by an NRTL and used in accordance with any instructions included in the listing/labeling for its intended purpose by the manufacturer.

System – A combination of components integrated into a unit to perform a specific task that is unlikely to change.

Unlisted Equipment – Equipment that has not been listed by an NRTL.

2.0 FIELD EVALUATION/DOCUMENTATION CRITERIA

Field evaluation of unlisted electrical equipment should be documented and made available to DOE upon request. The documentation and field evaluation criteria, as applicable, should be done as specified in this section. Documentation should be signed and may be kept in paper and/or a computer format (e.g. computer database).

It is recommended that each site or group of sites adopt a standard form (paper or computer-based) for each of the four types of examinations used by all electrical inspectors that is appropriate to site equipment. Examples of such forms appear in Section 6 of this Appendix.

2.1 IN-HOUSE-BUILT NON-NRTL/MODIFIED NRTL-LISTED ELECTRICAL EQUIPMENT

Documentation (see example in Section.6.1) should include, as appropriate:

- Equipment owner name (optional), Badge # (optional), group/organization
- Equipment name
- Equipment manufacturer
- Equipment model number
- Equipment serial number and property number, if applicable
- Equipment location (optional)
- Equipment status: new, modified, not previously approved, in-use, etc.
- Equipment type(optional):
 - Stand-alone custom built
 - System
 - Powered rack
 - Appliances and electrical tools
 - Powered workbench
 - Extension cords and relocatable power taps
 - Other

DOE-HDBK-1092-2013

- Function
- Usage:
 - Operating Environment
- Conditions of Usage/comments
- Electrical inspector tracking number if equipment is approved
- Date examined and approved/rejected
- Name of electrical inspector who examined and approved/rejected the equipment

Other than modified NRTL-listed electrical equipment shall^{C.4} be examined at a minimum, checking for the following items as appropriate:

- External Inspection:
 - Enclosure
 - Operator is not exposed to any hazard
 - Is not damaged
 - Is of appropriate material
 - Protects contents from operating environment
 - Power Source
 - Cords and Plugs
 - Proper voltage and ampacity rating for plug and cord
 - Grounding conductor included, if required
 - Are not frayed or damaged
 - Proper wiring of plug
 - Strain relief on cord
 - Direct wired into facility power
 - Proper voltage and ampacity rating for wiring method
 - Installation according to the National Electric Code (NEC)
 - Proper loading and overcurrent protection in branch circuit
 - Grounding
 - Ground from cord or other is properly terminated
 - All noncurrent-carrying exposed metal is properly bonded
 - All noncurrent-carrying internal subsystems are properly bonded
 - Equipment ground is run with circuit conductors
 - Auxiliary ground permitted
 - Check termination
 - Foreign Power Supplies and Equipment
 - Connected to facility power, with appropriate NRTL listed adapters
 - Correct voltage, frequency, and phasing
 - Correct wire ampacity for U.S. use
 - Overcurrent Protection
 - Adequate overcurrent protection in equipment, or branch circuit
 - Marking Requirements
 - Hazards, including stored energy
 - Power requirements (voltage, current or power, frequency)
 - Make/model/drawing number
 - Restrictions and limitations of use
 - Other Requirements

DOE-HDBK-1092-2013

- Documentation adequate
- Procedures to use
- Training and qualifications to use
- Secondary Hazards
 - RF hazards
 - DC electric or magnetic fields
 - IR, visible, or UV
 - X-rays
- Internal inspection:
 - Internal Wiring
 - Polarity correct
 - Phasing correct
 - Landing of ground correct
 - Separation of line voltage and high-voltage from low-voltage
 - Wiring terminals and leads
 - Wire size
 - Proper dielectric
 - Clearance/creepage distances for high-voltage
 - Listed conductors, if applicable
 - Other Internal Issues
 - Neat workmanship
 - Listed components used, if applicable
 - Proper management of conductors
 - Free of sharp edges
 - Proper cooling
 - Automatic discharge of high-voltage capacitor
- Tests performed as deemed appropriate by electrical inspector
 - Ground continuity (less than an ohm)
 - Polarization of cord and plug
 - Auto discharge of high-voltage capacitor
 - Functional tests (e.g. ground fault circuit interrupter (GFCI), emergency shut-off etc.)
- Failure Analysis
 - Effect of ground fault
 - Effect of short circuit
 - Effect of interlock failure
 - Effect of overload
 - Effect of incorrect setting
- Maintenance
 - Any safety issues with access and maintenance

2.2 FACILITY ELECTRICAL EQUIPMENT

Note: It is recommended that an electrical inspector who has background and experience working with, and/or on, facility equipment examine unlisted facility equipment.

Documentation (see example in Section 6.2) should include at a minimum:

- Equipment owner name (optional), Badge etc.# (optional), group/organization;
- Equipment name;

DOE-HDBK-1092-2013

- Equipment manufacturer;
- Equipment model number;
- Equipment serial number and property number if applicable;
- Equipment location (optional);
- Equipment function;
- The eight items checked;
- Conditions of use/comments;
- Electrical inspector tracking number, if equipment is approved;
- Date examined and approved/rejected; and
- Name of electrical inspector who examined and approved/rejected the equipment.

Facility unlisted electrical equipment shall^{C.2} be examined and approved by the AHJ prior to use at a minimum, checking for the following items:

- Suitability for installation and use in conformity with 29 CFR 1910 Subpart S, and/or, the NEC;
- Mechanical strength and durability, including for parts designed to enclose and protect other equipment, and the adequacy of the protection is thereby provided;
- Wire bending and connection space;
- Electrical connections and insulation;
- Heating effects under normal condition of use and also under abnormal conditions likely to arise in service;
- Arcing effects;
- Classification by type, size, voltage, current capacity, and specific use; and
- Other factors that contribute to the practical safeguarding of persons using or likely to come in contact with the equipment.

2.3 SYSTEM

The system as a whole needs to be evaluated along with each component and approved, but the inspector should consider the interactions and connections among the components in performing the evaluation.

Documentation (see example in Section 6.4) for the system should include at a minimum:

- The items required to be evaluated for system field evaluation;
- Conditions of use/comments;
- System description;
- Subsystems;
- System name;
- Manufacturer;
- Date built;

DOE-HDBK-1092-2013

- Date last modified;
- Number of pieces of equipment (e.g., 3 power supplies, 2 modulator racks);
- System status;
- System owner name (optional), Badge etc.#(optional), group/organization;
- Equipment location (optional);
- Specific tests performed for approval;
- Immediate improvements, required modifications (with a due date) and compensatory measures taken in the meantime;
- Name of division and group electrical inspector(s) who examined and approved/rejected the system; and
- Electrical inspector tracking number if equipment is approved.

Site organizations may approve unlisted electrical equipment as systems, with Site AHJ approval. Systems shall^{C.10} be examined at a minimum as follows:

- Hazard Assessment to include:
 - Electrical hazard classification);
 - Stored electrical energy in capacitors (E and V);
 - Batteries, including uninterruptible power supplies (UPS);
 - Electromagnetic fields produced (DC to 300 GHz, pulsed);
 - Infrared, optical, and UV;
 - X-rays;
 - Heat and sparks;
 - Acoustic energy; and
 - Other (e.g., chemical high pressure, cryogen, etc. This may require other subject matter expert (SME) review.
- Evaluation for operation to include:
 - Enclosure, isolation. There are no exposed hazardous energized conductors, no unused openings;
 - Grounding. All conductive enclosures exposed to personnel that may become energized shall^{C.11} be properly grounded;
 - Overcurrent protection. Overload protection, ground fault, and short circuit protection are in place;
 - Failure analysis. There are adequate electrical and fire protection systems for failure modes. (e.g. wiring, component failures etc.);
 - Operation safety analysis and controls are documented; and
 - System is labeled appropriately.
- Evaluation for working on system to include:
 - Method(s) of energy isolation (e.g., plug control, LOTO, Kirk key);
 - Automatic methods of stored energy removal;
 - Proper design for the manual removal and/or verification of capacitively stored energy; and
 - Documentation for entry and work on system.

3.0 EQUIPMENT FIELD EVALUATION NUMBERING

Approved electrical equipment should be assigned a field evaluation document file number (e.g. an approving assignment number, bar code, etc.).

3.1 MULTIPLE IDENTICAL MODEL UNITS

Multiple units from a manufacturer with identical models may have the field evaluation document file number assigned as follows:

- The same approving assignment number, bar code etc. may be used for multiple identical make and model units/systems; or
- The serial number (if available) or other unique identifier of each identical model unit/system identified as approved is documented on the same approval form used to document the approval of the representative sample, as specified in Section 1 of this Appendix.

4.0 LABELING APPROVED ELECTRICAL EQUIPMENT

Approved electrical equipment should be labeled (see examples in Section 8 of this Appendix). The approval label should be green colored with black and/or white as optional additional colors. The label should be placed in a conspicuous (clearly visible) location. ***The Field Evaluation number should be on the equipment or the label.*** It is recommended that each site adopt use of a standard label for easy identification by employees and contractors. (*Note: Environmental conditions should be considered to prevent label deterioration.*)

4.1 NRTL-LISTED ELECTRICAL EQUIPMENT LABEL (RECOMMENDED PRACTICE)

A label that indicates the equipment is NRTL-listed should be applied to NRTL-listed electrical equipment under the following conditions:

- The NRTL symbol (see <http://www.osha.gov/dts/otpca/nrtl/nrtlmrk.html>) is not in a conspicuous location (e.g., you cannot readily view it because the item is inaccessible in a rack or you need to open/disassemble the equipment enclosure to view the NRTL symbol, etc.); or
- The NRTL symbol(s) is difficult to read.

4.2 MULTIPLE IDENTICAL MODEL UNITS

All multiple identical model units documented, tracked, and approved by the AHJ, following the provisions of Section 3.1 of this Appendix should be labeled.

4.3 SYSTEMS

A system should be labeled or documented in such a manner that it is obvious to workers who use, work on, or work around the system that the system has been approved for use.

4.4 LOW-HAZARD EQUIPMENT

Equipment that is low-hazard equipment (as defined in this Appendix) may be labeled as such e.g., "Unlisted Approval Not Required" "Low-Hazard," or "Class X.0 X.1" to indicate it is equipment that does not require field evaluation and approval.

5.0 SPECIAL REQUIREMENTS FOR ELECTRICAL EQUIPMENT

5.1 SALVAGING/EXCESS/REMOVAL OF ELECTRICAL INSPECTOR APPROVED ELECTRICAL EQUIPMENT

The following applies to approved electrical equipment that is salvaged, excessed, or removed

from site property:

- For equipment that is salvaged or excessed, the approval is no longer valid and is void. Note: the label should be removed and the approval documentation updated to reflect removed equipment.
- For equipment going off site for use, the approval is no longer valid and is void unless the site that will use the equipment accepts the approval of the site the equipment came from. Note: Acceptance of equipment that has been labeled by another site's AHJ without further examination could be allowed, provided the receiving AHJ approves the equipment.

5.2 SUBCONTRACTOR UNLISTED ELECTRICAL EQUIPMENT

Appropriate management is responsible and should ensure all subcontractor unlisted electrical equipment used at a DOE site is approved. Subcontractors working on site property are responsible for assuring that all unlisted electrical equipment they use is listed or approved by an electrical inspector.

5.3 EQUIPMENT ACQUIRED FROM EXCESS/SALVAGE

Electrical equipment acquired from excess/salvage should be reviewed and approved following the field evaluation and documentation. Otherwise, follow the criteria listed in Section 2. If the equipment in storage is listed or previously approved, and is new and/or in good condition, requirements for field evaluation are at the discretion of the AHJ.

5.4 RENTAL EQUIPMENT

All rental electrical equipment should be evaluated and accepted by an electrical inspector prior to use according to the field evaluation and documentation regardless of its NRTL listing status.

6.0 EQUIPMENT APPROVAL FORMS

The following section contains sample forms for documenting the inspection and approval of the four types of electrical equipment examination discussed in Section 2, above, as well as the form for documenting multiple units.

6.1 IN-HOUSE-BUILT NON-NRTL/MODIFIED NRTL-LISTED ELECTRICAL EQUIPMENT APPROVAL FORM

SECTION 1 - Information		
Group:	Responsible Person: (optional)	employee#: (optional)
Equipment Name: <input type="checkbox"/> Multiple <input type="checkbox"/> Single		
Manufacturer:		
Model Number:		
Serial number of piece of equipment actually evaluated (see attached form for additional serial numbers of identical equipment):		
Property number of piece of equipment actually evaluated (see attached form for additional property numbers of identical equipment):		
Location Site:	Bld:	Room:
Identify Equipment Status: <input type="checkbox"/> New <input type="checkbox"/> Modified <input type="checkbox"/> Not Previously Approved <input type="checkbox"/> In Use		
Equipment Type: <input type="checkbox"/> Stand-alone custom built or other <input type="checkbox"/> System <input type="checkbox"/> Powered rack <input type="checkbox"/> Appliance/electrical tools <input type="checkbox"/> Powered workbench <input type="checkbox"/> Extension cord/relocatable power taps <input type="checkbox"/> Other		
Function and Use (duty cycle):		
Operating Environment: <input type="checkbox"/> Indoor/dry <input type="checkbox"/> Outdoor/wet/damp <input type="checkbox"/> Flammable vapor/dust/flyings <input type="checkbox"/> Explosives power/solid		
SECTION 2 – External Inspection		
Enclosure:	Foreign Power Supplies and Equipment:	
Operator not exposed to any hazard: <input type="checkbox"/>	Connected to facility power with appropriate adapters: <input type="checkbox"/> NA: <input type="checkbox"/>	
Not damaged: <input type="checkbox"/>	Correct voltage, frequency, and phasing: <input type="checkbox"/> NA: <input type="checkbox"/>	
Appropriate Material: <input type="checkbox"/>	Correct wire ampacity for U.S. use: <input type="checkbox"/> NA: <input type="checkbox"/>	
Protects contents from operating environment: <input type="checkbox"/>	Overcurrent Protection:	
Will contain any arcs, sparks, electrical explosions: <input type="checkbox"/>	Overcurrent protection: Equipment <input type="checkbox"/> Branch Circuit: <input type="checkbox"/> NA: <input type="checkbox"/>	
Power Source – Cord and plugs:	Marking Requirements:	
Proper voltage and ampacity rating for plug and cord: <input type="checkbox"/> NA: <input type="checkbox"/>	Hazards, including stored energy: Yes <input type="checkbox"/> NA: <input type="checkbox"/>	
Grounding conductor included if required: <input type="checkbox"/> NA: <input type="checkbox"/>	Power requirements (voltage, current, frequency)	
Not frayed or damaged: <input type="checkbox"/> NA: <input type="checkbox"/>	Restriction and limitations of use: Yes <input type="checkbox"/> NA: <input type="checkbox"/>	
Proper wiring of plug: <input type="checkbox"/> NA: <input type="checkbox"/>	Make/Model/Drawing number:	
Strain relief on cord: <input type="checkbox"/> NA: <input type="checkbox"/>	Other Requirements:	
Power Source – Direct wired into facility	Documentation adequate:	
Proper voltage and ampacity rating for wiring method: <input type="checkbox"/> NA: <input type="checkbox"/>	Procedures to use (IWD): Yes <input type="checkbox"/> No <input type="checkbox"/>	
Installation according to NEC: <input type="checkbox"/> NA: <input type="checkbox"/>	Training and qualification to use: Yes <input type="checkbox"/> No <input type="checkbox"/>	
Proper loading and overcurrent protection in branch circuit: <input type="checkbox"/> NA: <input type="checkbox"/>	Secondary Hazards:	
Grounding:	RF hazards: Yes <input type="checkbox"/> No <input type="checkbox"/>	
Ground from cord or other is properly terminated: <input type="checkbox"/> NA: <input type="checkbox"/>	DC electric or magnetic fields: Yes <input type="checkbox"/> No <input type="checkbox"/>	
All non-current carrying exposed metal is properly bonded: <input type="checkbox"/> NA: <input type="checkbox"/>	IR, visible, or UV: Yes <input type="checkbox"/> No <input type="checkbox"/>	
All non-current carrying internal subsystems are properly bonded: <input type="checkbox"/> NA: <input type="checkbox"/>	X-rays: Yes <input type="checkbox"/> No <input type="checkbox"/>	
Equipment ground is run with circuit conductors: <input type="checkbox"/> NA: <input type="checkbox"/>	Fire, electrical explosion: Yes <input type="checkbox"/> No <input type="checkbox"/>	
Auxiliary ground permitted: Check Termination: <input type="checkbox"/> NA: <input type="checkbox"/>		

IN-HOUSE-BUILT - CONTINUED (PAGE 2/2)

PART 2 – Internal Inspection	
Internal Wiring	Tests Performed
Polarity correct: <input type="checkbox"/> NA: <input type="checkbox"/>	Ground continuity (less than 1 ohm): <input type="checkbox"/>
Phasing correct: <input type="checkbox"/> NA: <input type="checkbox"/>	Polarization of cord and plug: <input type="checkbox"/>
Landing of ground correct: <input type="checkbox"/> NA: <input type="checkbox"/>	Auto discharge of high voltage capacitor: <input type="checkbox"/> NA: <input type="checkbox"/>
Separated - line voltage and high voltage from low voltage: <input type="checkbox"/> NA: <input type="checkbox"/>	Functional test (e.g., GFCI, emergency shut-off): <input type="checkbox"/> NA: <input type="checkbox"/>
Wiring terminals and leads ok: <input type="checkbox"/>	Others:
Wire sizes adequate: <input type="checkbox"/>	
Proper dielectric: <input type="checkbox"/>	Failure Analysis:
Clearance/creepage distances for high voltage ok: <input type="checkbox"/> NA: <input type="checkbox"/>	Effect of ground fault: <input type="checkbox"/>
Listed conductors, if applicable: <input type="checkbox"/>	Effect of short circuit: <input type="checkbox"/>
Other Internal Issues:	Effect of interlock failure: <input type="checkbox"/> NA: <input type="checkbox"/>
Neat workmanship: <input type="checkbox"/>	Effect of overload: <input type="checkbox"/>
Listed components used, if applicable: <input type="checkbox"/> NA: <input type="checkbox"/>	Effect of incorrect setting: <input type="checkbox"/> NA: <input type="checkbox"/>
Proper management of conductors: <input type="checkbox"/>	Others:
Free of sharp edges: <input type="checkbox"/>	Maintenance:
Proper cooling: <input type="checkbox"/>	Any safety issues with access and maintenance: Yes <input type="checkbox"/> No <input type="checkbox"/>
Automatic discharge of high voltage capacitor: <input type="checkbox"/> NA: <input type="checkbox"/>	Explain
Electrical inspector Tracking Number of Piece of Equipment Actually Evaluated (See next page for additional Tracking numbers of identical equipment if individual numbers were assigned):	

NOTE: APPROVED EQUIPMENT WILL BE INSTALLED AND USED IN ACCORDANCE WITH THE INSTRUCTIONS PROVIDED BY THE DESIGNER/BUILDER AND AHJ.

Condition of Usage/comments: (Include all designer/builder instructions, drawings, or information that is relevant to the safe installation and use of this equipment. Attach additional sheets as necessary.):

This equipment is **APPROVED** for installation and use at *YOUR INSTITUTION*. IF THIS EQUIPMENT IS MODIFIED, DAMAGED, OR UTILIZED FOR OTHER THAN THE INTENDED USE STATED ABOVE, THIS APPROVAL IS VOID, PENDING RE-EXAMINATION.

DATE:	AHJ approved -Electrical inspector Printed Name:	AHJ approved -Electrical inspector Signature

This equipment is **REJECTED** for use at *YOUR INSTITUTION* (see comments above).

DATE:	AHJ approved -Electrical inspector Printed Name:	AHJ approved -Electrical inspector Signature

6.2 FACILITY UNLISTED ELECTRICAL EQUIPMENT APPROVAL FORM

SECTION 1 - Information			
Group:	Responsible Person: (optional)	Employee #: (optional)	
Equipment Name: <input type="checkbox"/> Multiple <input type="checkbox"/> Single			
Manufacturer:			
Model Number:			
Serial number of piece of equipment actually evaluated (see attached form for additional serial numbers of identical equipment):			
Property number of piece of equipment actually evaluated (see attached form for additional property numbers of identical equipment):			
Location Site:	Bld:	Room:	
Identify Equipment Status: <input type="checkbox"/> New <input type="checkbox"/> Modified <input type="checkbox"/> Not Previously Approved <input type="checkbox"/> In Use			
Equipment Type: <input type="checkbox"/> Stand-alone custom built or other <input type="checkbox"/> System <input type="checkbox"/> Powered rack <input type="checkbox"/> Appliance/electrical tools <input type="checkbox"/> Powered workbench <input type="checkbox"/> Extension cord/relocatable power taps <input type="checkbox"/> Other			
Function:			
SECTION 2 – Inspection		APPROVE	REJECT
1. Suitability for installation and use in conformity with 29 CFR 1910 Subpart S and/or NEC.		<input type="checkbox"/>	<input type="checkbox"/>
2. Mechanical strength and durability, including for parts designed to enclose and protect other equipment, the adequacy of the protection thus provided.		<input type="checkbox"/>	<input type="checkbox"/>
3. Wire bending and connection space.		<input type="checkbox"/>	<input type="checkbox"/>
4. Electrical insulation.		<input type="checkbox"/>	<input type="checkbox"/>
5. Heating effects under normal conditions of use and also under abnormal conditions likely to arise in service.		<input type="checkbox"/>	<input type="checkbox"/>
6. Arcing effects.		<input type="checkbox"/>	<input type="checkbox"/>
7. Classification by type, size, voltage, current capacity, and specific use.		<input type="checkbox"/>	<input type="checkbox"/>
8. Other factors that contribute to the practical safeguarding of persons using or likely to come in contact with the equipment.		<input type="checkbox"/>	<input type="checkbox"/>
Electrical Inspector Tracking Number of Piece of Equipment Actually Evaluated (See next page for additional Electrical Inspector Tracking Numbers of identical equipment if individual numbers were assigned):			

NOTE: APPROVED EQUIPMENT WILL BE INSTALLED AND USED IN ACCORDANCE WITH THE INSTRUCTIONS PROVIDED BY THE DESIGNER/BUILDER AND AHJ.

Condition of Usage/comments: (Include all designer/builder instructions, drawings, or information that is relevant to the safe installation and use of this equipment. Attach additional sheets as necessary.):

This equipment is **APPROVED** for installation and use at *YOUR INSTITUTION*. IF THIS EQUIPMENT IS MODIFIED, DAMAGED, OR UTILIZED FOR OTHER THAN THE INTENDED USE STATED ABOVE, THIS APPROVAL IS VOID, PENDING REEXAMINATION.

DATE:	AHJ approved -Equip. Inspector Printed Name:	AHJ approved -Electrical Inspector Signature

This equipment is **REJECTED** for use at *YOUR INSTITUTION* (see comments above).

DATE:	AHJ approved -Equip. Inspector Printed Name:	AHJ approved -Electrical Inspector Signature

6.3 UNLISTED ELECTRICAL EQUIPMENT APPROVAL FORM

SECTION 1 - Information			
Group:	Responsible Person: (optional)	Employee #: (optional)	
Equipment Name: <input type="checkbox"/> Multiple <input type="checkbox"/> Single			
Manufacturer:			
Model Number:			
Serial number of piece of equipment actually evaluated (see attached form for additional serial numbers of identical equipment):			
Property number of piece of equipment actually evaluated (see attached form for additional property numbers of identical equipment):			
Location Site:	Bld:	Room:	
Identify Equipment Status: <input type="checkbox"/> New <input type="checkbox"/> Modified <input type="checkbox"/> Not Previously Approved <input type="checkbox"/> In Use			
Function:			
SECTION 2 – Inspection		APPROVE	REJECT
1. The case is grounded through the power cord to the grounding pin on the plug.		<input type="checkbox"/>	<input type="checkbox"/>
2. The plug is polarized, if necessary.		<input type="checkbox"/>	<input type="checkbox"/>
3. The equipment input voltage and frequency match those of the building's electrical system.		<input type="checkbox"/>	<input type="checkbox"/>
4. The equipment construction is suitable for the intended operating environment.		<input type="checkbox"/>	<input type="checkbox"/>
5. The equipment is in its original, unmodified and undamaged condition.		<input type="checkbox"/>	<input type="checkbox"/>
6. The equipment has externally accessible supplementary over-current protection (e.g., fuses) that are properly sized. (Equipment not having this, needs evaluation to determine if the equipment is safe for use)		<input type="checkbox"/>	<input type="checkbox"/>
Electrical Inspector Tracking Number of Piece of Equipment Actually Evaluated (See next page for additional Electrical Inspector Tracking Numbers of identical equipment if individual numbers were assigned):			

NOTE: APPROVED EQUIPMENT WILL BE INSTALLED AND USED IN ACCORDANCE WITH THE INSTRUCTIONS PROVIDED BY THE DESIGNER/BUILDER AND AHJ.

Conditions of Usage: Indoor Only Damp/Wet Locations Hazardous Classified Locations (Flammable/Explosive)

Comments: (Include all designer/builder instructions, drawings, or information that is relevant to the safe installation and use of this equipment. Attach additional sheets as necessary.):

This equipment is **APPROVED** for installation and use at *YOUR INSTITUTION*. IF THIS EQUIPMENT IS MODIFIED, DAMAGED, OR UTILIZED FOR OTHER THAN THE INTENDED USE STATED ABOVE, THIS APPROVAL IS VOID PENDING REEXAMINATION.

DATE:	AHJ approved -Equip. Inspector Printed Name:	AHJ approved -Electrical Inspector Signature

This equipment is **REJECTED** for use at *YOUR INSTITUTION* (see comments above).

DATE:	AHJ approved -Equip. Inspector Printed Name:	AHJ approved -Electrical Inspector Signature

6.4 ELECTRICAL SYSTEMS APPROVAL FORM

SECTION 1 – Information		
Approval is for intended use within the approving organization only		
Group:	Responsible Person: (optional)	Employee #: (optional)
System Name:		
System Description:		
Manufacturer, if any:		# of pieces of equipment in system:
Model Number, if any:		
Serial Number of System Actually Evaluated (see attached for additional serial numbers of identical equipment):		
Date Built:		Date Last Modified:
Location Site:	Bld:	Room:
Identify Equipment Status: <input type="checkbox"/> New <input type="checkbox"/> Modified <input type="checkbox"/> Not Previously Approved <input type="checkbox"/> In Use		
Function and List of Subsystems:		
SECTION 2 – Hazard Assessment		
Determine all electrical and non-electrical hazards that could injure an employee, including operation and maintenance workers.		
1	Electrical hazard classifications	
2	Stored electrical energy in capacitors (E and V)	
3	Batteries, including UPSs	
4	Electromagnetic fields produced (DC to 300 GHz, pulsed)	
5	IR, optical, or UV produced	
6	X-rays (give voltage value in vacuum)	
7	Heat and sparks	
8	Acoustic energy	
9	Other (chemical, high pressure, cryogen, etc.)	

SYSTEM APPROVAL FORM (PAGE 2/3)

SECTION 3 – Evaluation for Operation: Determine that engineering controls adequately protect the operators and users during system operation.		APPROVE	REJECT
1	Enclosure, isolation. No exposed hazardous energized conductors, no unused openings.	<input type="checkbox"/>	<input type="checkbox"/>
2	Grounding. All conductive enclosures exposed to personnel properly grounded.	<input type="checkbox"/>	<input type="checkbox"/>
3	Overcurrent protection. Provision for overload, ground fault, and short circuit	<input type="checkbox"/>	<input type="checkbox"/>
4	Failure analysis. Adequate electrical and fire protection systems for failure modes.	<input type="checkbox"/>	<input type="checkbox"/>
5	Operation safety analysis and controls documented where? e.g., IWD	<input type="checkbox"/>	<input type="checkbox"/>
6	System is labeled as approved, how?	<input type="checkbox"/>	<input type="checkbox"/>
7	Other, explain.	<input type="checkbox"/>	<input type="checkbox"/>
SECTION 4 – Evaluation for Working on System: Determine that engineering controls are implemented, in conjunction with work control to safely enter into and work on the system.		APPROVE	REJECT
1	Method(s) of energy isolation (e.g., plug control, LOTO, Kirk key)	<input type="checkbox"/>	<input type="checkbox"/>
2	Automatic methods of stored energy removal, if necessary	<input type="checkbox"/>	<input type="checkbox"/>
3	Proper design for the manual removal and/or verification of capacitively stored energy	<input type="checkbox"/>	<input type="checkbox"/>
4	Documentation for entry and work on system where? e.g., IWD	<input type="checkbox"/>	<input type="checkbox"/>
Electrical Inspector Tracking Number:			

NOTE: System will be installed and used in accordance with the instructions provided by the designer/builder and AHJ approval.

Comments/conditions of use: (Include all designer/builder instructions, restrictions on use, drawings or information that is relevant to the safe installation and use of this equipment. Attach additional sheets as necessary)

- This system and its associated electrical equipment is **APPROVED** for installation and use at *YOUR INSTITUTION*. IF THIS SYSTEM IS MODIFIED, DAMAGED, OR REPAIRED IN A MANNER THAT AFFECTS SAFETY, THIS APPROVAL IS VOID, PENDING RE-EXAMINATION BY AN ELECTRICAL INSPECTOR.
- This system is **REJECTED** for use at *YOUR INSTITUTION*. (See comments above.)

Note: The following signatures indicate that these electrical inspector(s) have reviewed some or all parts of this system for safety. In some cases an electrical inspector inspects only sections of the system for which their group is responsible. The head electrical inspector (if any) ensures that all components have been reviewed by one or more group electrical inspectors.

SYSTEM APPROVAL FORM (PAGE 3/3)

SECTION 5 – Approval Signatures				
Division/Group	Date:	Head Equipment Inspector Printed Name	Head Electrical Inspector Signature:	
Division/Group	Date:	Equip. Insp Printed Name	Equip. Inspector Signature:	
Division/Group	Date:	Equip. Insp Printed Name	Equip. Inspector Signature:	
Division/Group	Date:	Equip. Insp Printed Name	Equip. Inspector Signature:	
Division/Group	Date:	Equip. Insp Printed Name	Equip. Inspector Signature:	
SECTION 6 – Specific Tests Performed for Approval			Date	Who
List tests performed relevant to safety.				
1				
2				
3				
4				
5				
6				
7				
SECTION 7 – Immediate Improvements			Date	Who
List required modifications (with a due date) and compensatory measures taken to ensure safety if system is operated before modifications.				
1				
2				
3				
4				
5				
6				
7				

6.5 FORM FOR ADDITIONAL IDENTICAL UNITS

ELECTRICAL INSPECTOR Tracking Number:
--

Additional: Serial Numbers; Property Numbers (if applicable)

S#: P#:	S#: P#:	S#: P#:	S#: P#:	S#: P#:
S#: P#:	S#: P#:	S#: P#:	S#: P#:	S#: P#:
S#: P#:	S#: P#:	S#: P#:	S#: P#:	S#: P#:
S#: P#:	S#: P#:	S#: P#:	S#: P#:	S#: P#:
S#: P#:	S#: P#:	S#: P#:	S#: P#:	S#: P#:
S#: P#:	S#: P#:	S#: P#:	S#: P#:	S#: P#:
S#: P#:	S#: P#:	S#: P#:	S#: P#:	S#: P#:
S#: P#:	S#: P#:	S#: P#:	S#: P#:	S#: P#:
S#: P#:	S#: P#:	S#: P#:	S#: P#:	S#: P#:
S#: P#:	S#: P#:	S#: P#:	S#: P#:	S#: P#:
S#: P#:	S#: P#:	S#: P#:	S#: P#:	S#: P#:
S#: P#:	S#: P#:	S#: P#:	S#: P#:	S#: P#:
S#: P#:	S#: P#:	S#: P#:	S#: P#:	S#: P#:
S#: P#:	S#: P#:	S#: P#:	S#: P#:	S#: P#:

7.0 INSTRUCTIONS FOR USING EQUIPMENT INSPECTION FORMS

The following guidance will help the electrical inspector to use the above equipment inspection and approval forms.

7.1 INSTRUCTIONS FOR THE IN-HOUSE-BUILT NON-NRTL/MODIFIED NRTL LISTED ELECTRICAL EQUIPMENT APPROVAL FORM

These instructions provide assistance, clarification, and additional details to electrical inspectors while performing examinations using the In-House-Built Non-NRTL/Modified NRTL-Listed Electrical Equipment Approval Form.

1. Enclosure:

- Operator not exposed to any hazard
 - Check to make sure the enclosure contains or covers all conductors and energized terminals, to prevent inadvertent contact with energized conductors;
 - Make sure any knockouts are plugged; and
 - Look for unusually sharp edges, or pinch hazards.
- Not Damaged
 - Ensure that the enclosure is free from defects/dents, securely fastened, and that all components are intact.
- Appropriate materials used
 - Ensure that the enclosure material can withstand normal use and that it can protect the contents and user adequately.
- Protects contents from operating environment
 - Make sure that the enclosure is rated for the environment such as outdoor, corrosive, wet or humid environments, or classified locations (NEC Article 500 type locations).
- Adequate shock protection
 - Ensure adequate enclosure, insulation, etc. to prevent incidental exposure to energized electrical conductors or parts.
- Will contain any arcs, sparks, and electrical explosions
 - Ensure that the enclosure is rated or suitable for the bolted fault energy of the input source; and
 - Refer to National Electrical Manufacturers Association (NEMA) Enclosure Types as appropriate.

2. Power source – cord and plug:

- Proper voltage and ampacity rating for plug and cord
 - See ampacity information in Section 11.12 of the DOE Handbook for Electrical Safety.

- Grounding conductor included (if required)
 - Make sure the ground conductor has good continuity (<1 Ohm) to the enclosure and any exposed metal surfaces.
 - Not frayed or damaged
 - Inspect the cord and plug for cracks or cuts in the insulation.
 - Proper wiring of plug
 - Refer to NEMA Straight Blade Chart.
 - Strain relief on cord
 - If the power cord is hardwired to the enclosure a proper strain relief/insulator shall^{C.12} be used to prevent damage to the cord.
3. Power source direct wired:
- Proper voltage and ampacity rating for wiring method
 - See ampacity information in Section 11.12 of the DOE Handbook for Electrical Safety.
4. Foreign power supplies and equipment:
- Connected to facility power with appropriate adapters
 - Adapter rating matches used voltages and is NRTL-listed.
 - Correct voltage, frequency and phasing
 - Ensure the equipment will operate properly on 60 Hz line voltage; and
 - Make sure the line, neutral and ground connections are correct on the input and output of any transformers. This is especially important for autotransformers when stepping 120 VAC up to 220 VAC.
 - Correct wire ampacity for U.S. use
 - See ampacity information in Section 11.12 of the DOE Handbook for Electrical Safety.
5. Grounding
- Ground is properly terminated
 - The green grounding conductor from the power source should be used as a single point ground inside the enclosure.
 - All noncurrent-carrying exposed metal is properly bonded
 - The exposed metal of the enclosure should be bonded to the ground conductor with clean, unpainted connections.
 - All noncurrent-carrying internal subsystems are properly bonded
 - Internal components which require a ground should be bonded to the single point ground or through the enclosure using clean, unpainted connections.
 - Equipment ground is run with circuit conductors

- Auxiliary ground is permitted
 - An extra ground connection in addition to the power source ground is acceptable.
- 6. Internal wiring:
 - Polarity correct
 - Make sure the neutral and line are properly connected internally.
 - Phasing correct
 - For three phase power, try to determine if the phasing is correctly connected. Some devices have phase detection LEDs, or other means to determine correct phase. Refer to the manual, if available.
 - Landing of ground correct
 - The green grounding conductor from the power source should be connected to the metal enclosure.
 - Separate line/high-voltage from low-voltage
 - Make sure the low-voltage (<50 V) and high-voltage (≥50 V) conductors are not run in the same wire bundles.
 - Wiring terminals and leads ok (no tension on terminals)
 - Inspect the terminals and wire to ensure the connectors are tight and that there is no physical stress on the conductors (such as wires pulled taut).
 - Proper wire size and color code
 - Make sure the wire is rated for the correct operating voltage and current (see ampacity information in Section 11.12 of the DOE Handbook for Electrical Safety); and
 - Wire insulation should conform to color code standards. Refer to proper table or reference in Color Coding Guidelines at the end of this Appendix.
 - No loose parts (mechanical bracing)
 - All parts should be secured internally and should not rely on gravity to maintain position.
 - Proper overcurrent protection
 - Appropriate fuses and or circuit protectors should be used on the input source and on the input to any power components in the enclosure. These overcurrent devices should be labeled with the correct ratings. Overcurrent devices shall^{C.13} be installed on the line (not neutral) side of the input power feed.
 - Proper dielectric
 - Where insulation is required between components, make sure the dielectric can withstand the operating voltages.
 - Clearance/creepage distances for high-voltage
 - Ensure there is sufficient clearance for high-voltage to prevent arcing or dielectric breakdown.

7. Marking requirements:

- Power requirements (voltage, current, frequency)
 - The source power (voltage, frequency, and either current or wattage) should be labeled on the enclosure at the point of entry for the power cable. (e.g., 120VAC 2A 60 Hz, or 208 VAC 500 watt 60 Hz).
- Restrictions and limitations of use
 - Any limitations of use should be clearly labeled to prevent the device from being used inappropriately.
- Make, model and drawing number
 - For a manufactured device, the manufacturer, model number, serial number should be listed on the enclosure. An in-house built device usually will not have a model or serial number. In this case, the approval sticker can become the serial number.
- Hazards, including stored energy
 - Hazards such as hazardous stored energy, high-voltage, high-current, RF etc. should be labeled on the enclosure.
- Requirements for access (lockout/tagout (LOTO), stored energy, personal protective equipment (PPE))
 - If the equipment requires LOTO or special procedures for access during maintenance or troubleshooting, labeling should be used to direct personnel to the appropriate documents for servicing the equipment. The documentation should have a work procedure and should list the personal protective equipment (PPE) requirements.

8. Tests performed:

- Ground continuity less than 1 ohm
 - This test ensures that the ground wire from the source is securely connected to the equipment ground point. Use a quality digital volt meter (DVM) with a resolution of 0.1 ohm or better to make this measurement. Short the leads to determine the lead resistance and subtract this reading from the ground test reading.
- Polarization of cord and plug
 - Use a DVM to confirm that the neutral and line are properly connected to the plug and to the internal circuitry.
- Functional test (GFCI, Emergency Shut OFF)
 - If the equipment has a GFCI or Emergency Shut OFF, test that these devices are operational.
- Automatic discharge of high-voltage capacitor
 - For equipment with high-voltage capacitors or large capacitor banks, ensure a method is used to automatically discharge the capacitors. Bleeder resistors are typically used to discharge capacitors. For large energy capacitor banks there should be engineered controls and procedures in place to ensure the capacitors have fully discharged before access can be made to the terminals.

9. Other Issues:

- Neat Workmanship
- Proper management of conductors
 - This refers to proper lead dress and keeping high-voltage leads separated from low-voltage leads. Barrier strips and terminals should be used, rather than wire nuts and tape. Wire bundles should be secured to prevent them from moving.
- Free from sharp edges
 - The enclosure feedthroughs should be deburred and have appropriate grommets or strain reliefs for and wires or cables. The enclosure should also be free from sharp edges which could cause the user to be cut or which could pierce any conductor insulation.
- Proper cooling
 - Equipment which dissipates enough power to cause excessive heat buildup in the enclosure should have a fan, or proper ventilation, to keep the temperature below the rating of the wire or internal devices. A rule of thumb is to keep the temperature below 50° C.
- Switches and controls readily accessible
 - The controls should be conveniently located for the user to operate without difficulty. Good design practices will ensure a logical placement for the equipment controls.

10. Maintenance

- Safety issues with access and maintenance
 - Equipment which requires maintenance by personnel should have appropriate engineered controls to prevent exposing the workers to hazardous conditions;
 - Examples of engineered controls include: interlocks, bleeder resistors across capacitors, covers over exposed terminals, and LOTO capability; and
 - Look for controls and or procedures which are used for maintenance operations.

11. Failure analysis:

- Effect of ground fault
 - Analyze the effects of a ground fault and the resulting condition. Does the equipment pose a hazard should a ground fault occur?
- Effect of short circuit
 - Ensure that the circuit protection devices (i.e. fuses, circuit breakers etc.) are adequate to protect the equipment and personnel in the event of a short circuit in the device or load.
- Effect of interlock failure
 - Would an interlock failure create a hazardous condition? What controls are in place to prevent injury?

- Effect of overload
 - Ensure that the circuit protection devices (i.e. fuses, circuit breakers etc) are adequate to protect the equipment and personnel in the event of an overload. An overload could occur from the user applying too much power to the load, or using an inappropriate load.
- Effect of incorrect setting
 - This basically refers to the consequences of the operator inadvertently placing the controls in a wrong position or using the controls inappropriately. The system should be designed to minimize hazards due to accidental inputs or controls. These include interlock, fail-safe systems and inability to allow the system to be operated in a hazardous manner.

12. Secondary hazards

Note: For all non-ionizing radiation safety refer to the appropriate site's safety document chapter.

- Radio Frequency (RF) hazards
 - Does this equipment produce harmful RF? If so, proper RF shielding should be in place and leakage fields should be measured.
- DC electric or magnetic fields
 - If the equipment produces strong magnetic fields safeguards should be in place to prevent injury by accidental contact with ferromagnetic material, such as tools. Placards should be in place to warn people of the presence of high-magnetic fields. This is very important for people with pacemakers.
- Infrared (IR), visible or ultraviolet (UV)
 - Safeguards should be in place to prevent exposure to high levels of electromagnetic radiation. Laser systems are especially dangerous for IR or UV radiation. Refer to the site's safety document chapter on laser safety.
- X-Rays
 - Refer to the site's safety document chapter pertaining to X-ray safety to ensure all interlocks and safety measures are covered in the system design.
- Fire or electrical explosion
 - The system should be designed to minimize the risk from an explosion or fire due to a system fault. The enclosure should be robust enough to contain the available energy due to a fault.

13. Documentation

- Documentation adequate
 - The user should have the owner's manual for purchased equipment. "Homebrew" equipment should have at least a schematic diagram.
- Operating procedures
 - The operating procedures should be readily available to the users.

- Training and qualifications to use
 - If use of the equipment warrants training, sufficient instructions or training are provided prior to use.

7.2 INSTRUCTIONS FOR THE FACILITY ELECTRICAL EQUIPMENT APPROVAL FORM

PART 1 – Equipment Identification

- Enter as much information as necessary to be able to track adequately.
- Equipment Status refers to equipment operation. If equipment is new or modified, it should be examined and approved using the checklist in Section 2 of this Appendix. If equipment has not been previously approved, the equipment should be examined and approved before use.
- The function should be stated to give a short description of the use of the equipment.

PART 2 – Example Guidelines for Equipment Approval

1. Some potential considerations of suitability for installation and use are as follows:
 - Operation, considering environmental conditions.
 - Temperature, humidity, air pressure, non-ionizing radiation (RF and electromagnetic interference (EMI)), ionizing radiation, outdoor/indoor, etc.
 - Normal and abnormal use, considering duty cycle, average and peak power, etc.
 - Properly sized and installed equipment grounding (chassis grounding).
 - Equipment design that includes consideration of the available short circuit and ground fault current.
 - Properly sized and installed overcurrent protection (fuses or circuit breakers).
 - Separation of high- and low-voltage components, especially where high-voltage could escape along a hidden fault path.

(See NEC 250.110 & 110.9.)
2. Mechanical strength and durability considerations include the following:
 - Enclosure of parts to:
 - Prevent damage to internal components during use and transportation;
 - Contain arcing, heating, and explosion;
 - Prevent injury to personnel from hazardous energized parts; and
 - Prevent damage to internal components from environmental conditions.
 - Workmanship – unused openings effectively closed
 - Integrity of electrical equipment and connections
 - Any item that would adversely affect the safe operation or mechanical strength of the equipment, such as damaged, corroded, or overheated parts

(See NEC 110.12.)

3. Wire bending and connection space includes the consideration of assembly and potential repair, based on the following:
 - The protection of conductors and their insulation against damage by over-bending, over-crowding, or location near moving parts in equipment, and at termination points.
(See NEC 312.6 and Tables 312.6(a) & (b).)
4. The integrity of insulation ensures that the system or component does the following:
 - Prevents the escape/transfer of electrical energy to other conductors and to personnel;
 - Is free from short circuits or potential short circuits;
 - Uses listed conductors where possible; and
 - Is free from grounds other than those required or permitted by Article 250 of the NEC.
(See NEC 110.7.)
5. Verify that conductors are installed and used in such a manner that normal listed or approved temperature ratings are not exceeded. If the condition of use in the R&D environment is substantially different from that anticipated in the product listing, have an SME determine that an appropriate level of safety is maintained. Also determine that exposed parts will not burn personnel or initiate fires.
(See NEC 310.10, including the fine print note.)
6. Appropriate requirements for arcing effects include the following:
 - If the equipment's ordinary operation produces arcs, sparks, flames, or molten metal, verify that it is enclosed or separated and isolated from all combustible material.
 - Verify that potential arc blast/electrical explosions are prevented from injuring personnel and damaging other equipment.
(See NEC 110.18.)
7. Require that a permanent label be attached to the equipment that includes the following:
 - The manufacturer's (or local builder's) name or other descriptive marking by which the organization responsible for the equipment can be identified.
 - Other markings will include the equipment voltage, current, wattage, and any additional wording that the electrical inspector deems necessary for the safe operation of the equipment (e.g., type, size, power, stored energy, secondary hazards, specific use, and specific users).
(See NEC 110.21.)
8. Other factors contributing to the practical safeguarding of personnel include the following:
 - Reviewing non-electrical hazards by appropriate SMEs.
 - Preventing electric shock, burn, or reflex hazards by eliminating personnel contact.

DOE-HDBK-1092-2013

- Ensuring that energized parts of equipment operating at 50 V or more are protected against accidental contact by approved enclosures or by any of the following means:
 - By location in a box, enclosure, room, or vault that is accessible only to electrical inspectors;
 - By suitable permanent, substantial partitions or screens arranged so that only electrical inspectors will have access to the space within reach of the energized parts;
 - By location on a suitable balcony, gallery, or platform elevated and arranged so as to exclude unqualified people from entering the limited approach boundary; or
 - By elevation of 8 feet or more above the floor or other working surface.
 - A procedure for safe energy removal, e.g., disconnection, LOTO, removal of stored energy, when both normal/emergency shutdown has been established.
 - Damage to eyes, skin or other equipment from UV and IR.
 - Personnel injury or equipment interference from RF fields.
 - Preventing personnel exposure to excessive noise.
 - Preventing personnel exposure to X-rays for equipment >15 kV operating, especially in a vacuum.
 - Standard designs, including fail-safe design:
 - Use listed or recognized components, where possible; and
 - Use accepted color coding of wires, especially grounded (white or gray) and grounding conductors (bare or green).
 - Consider the loss of electrical power, pneumatic, etc.
 - Consider the automatic removal of stored energy.
 - Consider the use of interlocks on enclosures and other systems.
- (See NEC 110.27 and 110.31.)

8.0 EXAMPLE EQUIPMENT APPROVAL LABELS

ELECTRICAL SAFETY APPROVED	
File No.	_____
Division / Group	_____
ESO	_____ Date _____
Approved for the intended use only within the approving organization. Refer to LIR402-600-01.	

Los Alamos National Laboratory (LANL) Label



Sandia National Laboratory (SNL) Label



Argonne National Laboratory (ANL) Label

Acronyms

AHJ	authority having jurisdiction
CFR	Code of Federal Regulations
DOE	Department of Energy
DVM	digital volt meter
IR	Infrared
GFCI	ground fault circuit interrupter
LOTO	lockout/tagout
NEC	National Electrical Code
NRTL	Nationally Recognized Testing Facility
O	DOE Order
OSHA	Occupational Safety and Health Administration
PPE	personal protection equipment
QA	quality assurance
RF	radio frequency
R&D	research and development
SME	subject matter expert
UL	Underwriters Laboratory
UPS	uninterruptible power supply
UV	ultraviolet

References

Department of Labor-OSHA

29 CFR 1910, Occupational Safety and Health Standards.

National Fire Protection Association

NFPA 70, National Electrical Code, 2008.

APPENDIX D HAZARD ANALYSIS

1.0 INTRODUCTION

This Appendix provides tools for assessing electrical hazards (Step 2 of Integrated Safety Management, or ISM), and provides the recommended controls for mitigating those hazards (Step 3 of ISM). It should not be considered mandatory, or as the only method of analyzing electrical hazards. Section 2 presents various types of electrical injury, Section 3 presents the four modes of work on electrical equipment, and Section 4 presents the boundaries associated with the distance of the worker from the exposed electrical hazard. Section 5 presents methods of shock and arc flash analyses for AC facility power and DC research and development (R&D) power. Section 6 presents the types of controls used to protect the worker from exposed electrical hazards. Finally, Section 7 classifies electrical hazards as determined by the possible injury, and provides the recommended controls for mitigation of the hazard for the various modes of work on electrical equipment. This classification is not to be confused with the hazard risk categories for personal protective equipment (PPE), defined in National Fire Protection's NFPA 70E, *Standard for Electrical Safety in the Workplace*.

In this Appendix, "shall" refers to requirements of regulatory standards identified in the Code of Federal Regulations (CFR) in 10 CFR 851, *Worker Health and Safety Program*, which may or may not apply to a specific location (e.g. Southwestern Power Administration, Western Area Power Administration, Bonneville, etc.). Even though the process is not mandatory, some mandatory elements are included to comply with regulations mandatory at all DOE workplaces.

An assessment of the electrical hazards shall^{D.1} be performed for all work that requires employees to work on, or near, exposed electrical conductors or circuit parts. The assessment should be done by a qualified worker to determine the required safety-related work practices. When an electrical hazard exists, the exposed circuit parts shall^{D.2} be placed into an electrically-safe work condition unless it is infeasible to do so.

There are requirements for de-energization and verification for some classes of electrical hazards. If the work is done with a hazardous energized circuit, safety-related work practices and procedures shall^{D.3} be followed to eliminate or control the electrical hazards.

Effective hazard assessments should consider equipment failure modes, possible accidents, documentation inadequacies, procedural failure, and human error.

This Appendix does not provide an exhaustive list of sources of electrical energy and their associated hazards and controls; rather it provides the framework for categorizing those hazards to provide for enhanced worker safety.

2.0 ELECTRICAL HAZARDS

There are numerous injury mechanisms from exposure of a worker to electrical energy. This section briefly presents the various types of injury.

2.1 ELECTRICAL SHOCK

Electricity is one of the most commonly encountered hazards in any facility. Under normal conditions, safety features (engineering controls) built into electrical equipment protects workers from shock. Shock is the flow of electrical current through any portion of the worker's body from

an external source. Accidents can occur in which contact with electricity results in serious injury or death.

Most electrical systems establish a voltage reference point by connecting a portion of the system to an earth ground. Because these systems use conductors that have electrical potential (voltage) with respect to ground, a shock hazard exists for workers who are in contact with the earth and exposed to the conductors. If a person comes in contact with an energized (ungrounded) conductor, while also in contact with a grounded object, an alternate path to ground is formed in which current passes through his or her body.

The effects of electric current on the human body depend on many variables, including the:

- amount of current;
- waveform of the current (e.g., DC, 60 Hz AC, RF, impulse);
- current's pathway through the body (determined by contact location and internal body chemistry);
- duration of shock; and
- energy deposited into the body.

The amount of current passing through the body depends on:

- voltage driving the current through the body;
- circuit characteristics (impedance, stored electrical energy);
- frequency of the current;
- contact resistance and internal resistance of the body; and
- environmental conditions affecting the body's contact resistance.

The heart and brain are the parts of the body most vulnerable to electric shock. Some research shows that fatal ventricular fibrillation (disruption of the heart's rhythmic pumping action) can be initiated by a current flow of as little as 70 milliamperes (mA)*. Without immediate emergency resuscitation, electrical shock may cause a fatality from direct paralysis of the respiratory system, disruption of rhythmic pumping action, or immediate heart stoppage. Severe injuries, such as deep internal burns, can occur, even if the current does not pass through vital organs or the central nervous system. Specific values for hazardous voltages and for hazardous current flow through the body are not completely reliable because of physiological differences between people.

There are five principal electrical waveforms of interest that cause various responses to electrical shock:

1. Alternating current (AC) power frequencies;
2. Direct current (DC);
3. Sub radio frequencies (sub RF);
4. Radio frequencies (RF); and
5. Impulse shock (such as from a capacitor circuit).

The most dangerous are AC power frequencies, typically 60 hertz (Hz). Exposure to current at these frequencies causes ventricular fibrillation at the lowest thresholds and causes severe contraction of the muscles with a possible no-let-go response.

Exposure to DC electric currents can also cause a muscle response at first contact and when releasing, as well as heart fatigue and failure at high enough current levels. RFs (3 kilohertz (kHz), to 100 megahertz (MHz)) have decreasing neurological effects with increasing frequency, but energy deposited results in tissue burning.

The resistance of the body is much less if the skin is punctured by a shock above the skin breakdown threshold (400 to 500 V). This allows higher current flow through the body, resulting in more damage. The amount and duration of current flow determines the severity of the reflex action, the amount of damage to the heart, and neurological and other tissue.

Reflex action occurs when electric current causes a violent contraction of the muscles. Such contraction can result in violent recoil, resulting in falling from heights, recoiling into a nearby hazard, or violent muscle contractions resulting in broken bones, torn ligaments, or dislocated joints. Reflex action is enhanced by high-voltage shock as the energy can be delivered more quickly from higher instantaneous currents.

The so called no-let-go response occurs when continuous shock current keeps the muscles violently contracting such that the victim is clutching the conductor without any ability to release. Because of the effects of the waveform on the body's response, the thresholds for acceptable shock vary, depending on the form of the electricity. Acceptable means that below these thresholds there is no injury, and above these thresholds there could be injury. The thresholds are listed in Table D-1 and are found embedded in the hazard classification charts in Section 7 of this Appendix. The threshold values are based on available research and theoretical data*. The hazard class values reflect the consensus agreement of a task group that developed the process, based on the collective knowledge and experience. The values should not be considered absolute, but guidance when applying effective hazard analysis to a particular task.

*Several research projects have provided a basis for the effects of electricity on the human body. The results of one such project was reported at the Meeting of Experts on Electrical Accidents and Related Matters in Geneva Switzerland in October 1961, In his report titled: "Deleterious Effects of Electric Shock," Professor C.F. Dalziel cited both his and previous studies that support the conclusion that 70 milliamperes of current through the heart for 5 seconds would cause ventricular fibrillation.

Source	Includes	Thresholds	Hazard Classes
AC	60 Hz	>50 V and >5 mA	1.2, 1.3, 1.4, 1.5
DC	All	>100 V and >40 mA	2.2c, 2.2d, 2.3, 2.4
Capacitors	All	>100 V and >1 J, or >400 V and >0.25 J	3.2b, 3.2c, 3.3b, 3.3c, 3.3d, 3.4b, 3.4c
Batteries	All	>100 V	Could be in any Class 4.0, 4.1, 4.2, 4.3
Sub-RF	1 Hz to 3 kHz	>50 V and >5 mA	6.2a, 6.2b, 6.2c, 6.3, 6.4
RF	3 kHz to 100 MHz	A function of frequency	5.2a, 5.2b

Table D-1. Thresholds for defining shock hazards.

NOTES:

1. It is possible for a worker to be exposed to more than one shock hazard at any given location (e.g. multiple types of sources).
2. There may be other electrical hazards below the above shock thresholds (e.g., a thermal burn hazard-see Table D-3).
3. Injuries may result from startle reactions due to contact with energized components, even though the source energy is too low to do physical damage, such as high-voltage/low-current circuits (e.g., Classes 2.1d and 3.1d).
4. Shock and burn hazards from induced and contact RF currents become negligible above 100 MHz (but radiated hazards still exist).
5. See the following references for more information on the effects of electricity on the human body:
 - a. Jensen PJ, Thomsen PE, Bagger JP, Norgaard A, Baandrup U. "Electrical injury causing ventricular arrhythmias." *Br Heart J*. Mar 1987;57(3):279-83.
 - b. "Correlation Between Accident Parameters and Sustained Injury" IEEE Paper PCIC-96-35 Mary Capelli--Schellpfeffer, Ralph C. Lee, Mehmet Toner, and Kenneth R. Diller.
 - c. "Behavioral Consequences Of Lightning And Electrical Injury" Margaret Primeau, Ph.D., Gerolf H. Engelstatter, Ph.D., A.B.M.P., I.A.B.C.P., and Kimberly K Bares, M.S. Seminars in Neurology, Volume 15, Number 3, September 1995 Department of Psychology, Finch University of Health Sciences/The Chicago Medical School, North Chicago, Illinois, and Carolina Psychological Health Services, Jacksonville, North Carolina.
 - d. "Effect of Wave Form on Let-Go Currents," Charles F. Dalziel, AIEE Transactions December 1943, Volume 62, Pages 739-750 (The citation includes another paper by the same author titled: "Effect of Frequency on Let-Go Currents" as well as references to other studies).
 - e. IEEE/ANSI C95.1 (1999) "Standard for Safety Levels With Respect to Human Exposure to Radio Frequency Electromagnetic Fields, 3KHz to 3000GHz.

2.2 ELECTRICAL BURN

Burns suffered in electrical accidents are of three basic types – electrical burns, arc burns, and thermal contact burns. The cause of each type of burn is different, and prevention necessitates different controls.

2.2.1 Electrical Burns

In electrical burns, tissue damage (whether skin-level or internal) occurs because the body is unable to dissipate the heat from the current flow. Typically, electrical burns are slow to heal. Such electrical burns result from shock currents, and thus adhering to the shock current thresholds in Table D-1 should prevent electrical burns.

2.2.2 Arc Flash Burns

Arc flash burns are caused by electric arcs and are similar to heat burns from high-temperature sources. Temperatures generated by electric arcs can melt nearby material, vaporize metal in close vicinity, and burn flesh and ignite clothing at distances of several meters, depending on the energy deposited into the arc. The arc can be a stable low-voltage arc, such as in an arc welder, or a short-circuit arc at higher voltage, resulting in an arc flash and/or arc blast. Such an expanding arc can ignite clothing and/or cause severe burns at a distance from inches to feet. The flash protection boundary is defined to characterize the distance at which this injury mechanism is severe. Hazard classes that include arc flash hazards are shown in Table D-2. The current values are the short circuit available currents, or fault currents. The threshold values are based on available research and theoretical data. The hazard class values reflect the consensus agreement of the task group that developed the process based on the collective knowledge and experience. The values should not be considered absolute, but, rather as guidance when applying effective hazard analysis to a particular task. See Note 5 to Table D-1 for references that provide a basis for the threshold values. In addition, for some information regarding dc values, see “DC Arc Hazard Assessment Phase II,” Report No. K-012623-RA-0002-R00, Kinectrics Inc.

Source	Includes	Thresholds	Hazard Classes
60 Hz power	60 Hz	<240 V and the transformer supplying the circuit is rated >125 kVA <240 V and the circuit is supplied by more than one transformer >240 V	1.2, 1.3, 1.4, 1.5
Sub-RF	1–3 kHz	>250 V and >500 A	6.4
DC	All	>100 V and >500 A	2.4
Capacitors	All	>100 V and >10 kJ	3.4b, 3.4d
Batteries	All	>100 V and >500 A	4.3
RF	NA	NA	

Table D-2. Thresholds for defining arc flash hazards

2.2.3 Arc Blast Hazards

A rapid delivery of electrical energy into an arc can cause additional hazards not covered by arc flash hazards. The acoustical shock wave, or arc blast pressure wave, can burst eardrums at lower levels and can cause cardiac arrest at high enough levels. In addition, high currents (> 100 kA) can cause strong magnetic forces on current-carrying conductors, which can lead to equipment destruction, or the whipping of conductors. Such arc blast hazards are of particular concern in high-energy facility power circuits (Classes 1.3d, 1.4, and 1.5) and large capacitor banks (Class 3.4d).

2.2.4 Thermal Contact Burns

Thermal contact burns are those that occur when skin comes into contact with the hot surfaces of overheated electrical conductors, including conductive tools and jewelry. This injury results from close proximity to a high-current source with a conductive object. Thermal burns can occur from low-voltage/high-current systems that do not present shock or arc flash hazards, and controls should be considered. The controls to prevent injury from shock and arc flash should also protect against thermal contact burn. High-current hazard classes with thermal burn hazards are shown in Table D-3. The threshold values are based on available research and theoretical data. The values are calculated to raise the temperature of the skin to a level that would cause a second-degree burn using the Stoll Curve at a time of two seconds. The hazard class values reflect the consensus agreement of the task group that developed the process based on the collective knowledge and experience. The values should not be considered absolute, but guidance when applying effective hazard analysis to a particular task.

Source	Includes	Thresholds	Hazard Classes
Sub-RF	1–3 kHz	<50 V and >1000 W	6.2a
DC	All	>100 V and >1000 W	2.2a, 2.2b
Capacitors	All	<100 V and >100 J	3.2a, 3.3a, 3.4a
Batteries	All	<100 V and >1000 W	4.2, 4.3
RF	NA	NA	

Table D-3. Thermal contact burn hazards, not included in shock and arc flash hazards.

2.3 DELAYED EFFECTS

Damage to the internal tissues may not be apparent immediately after contact with electrical current. Delayed swelling and irritation of internal tissues are possible. In addition, imperceptible heart arrhythmia can progress to ventricular fibrillation. In some cases, workers have died two to four hours after what appeared to be a mild electrical shock. Immediate medical attention may prevent death or minimize permanent injury. All electrical shocks should be reported immediately.

2.4 BATTERY HAZARDS

During maintenance or other work on batteries and battery banks, there are electrical and physical hazards that should be considered. In addition, when working near or on flooded lead-acid storage batteries additional chemical and explosion hazards should be considered. The hazards associated with various types of batteries and battery banks include:

- Electric shock;
- Burns and shrapnel-related injuries from a short circuit;
- Chemical burns from electrolyte spills or from battery surface contamination;
- Fire or explosion due to hydrogen;
- Physical injury from lifting or handling the cells; or
- Fire from overheated electrical components.

2.5 OTHER HAZARDS

2.5.1 Low-Voltage Circuits

Low-voltage circuits, which are not hazardous themselves, are frequently used adjacent to hazardous circuits. A minor shock can cause a worker to rebound into the hazardous circuit. Such an involuntary reaction may also result in bruises, bone fractures, and even death from collisions or falls. The hazard is due to the secondary effects of the reflex action.

2.5.2 Operating Electrical Disconnects

An arc may form when a short circuit occurs between two conductors of differing potential, or when two conductors carrying current are separated, such as a safety switch attempting to interrupt the current. If the current involved is high enough, the arc can cause injury, ignite flammable materials or initiate an explosion in combustible or explosive atmospheres. Injury to personnel can result from the arc flash, or arc blast, resulting in severe burns to exposed skin, or ignition of clothing. Equipment or conductors that overheat, due to overload, may ignite flammable materials. Extremely high-energy arcs can cause an arc blast that sends shrapnel flying in all directions.

2.5.3 R&D Electrical Equipment

Analyzing electrical hazards associated with R&D equipment may present challenges beyond that associated with standard electrical distribution equipment. Some R&D equipment is custom designed and built and may need specific qualifications for workers that operate or maintain the equipment. An uncommon or unique design can be difficult to analyze for hazard identification. Regardless, the hazard analysis should include shock, potential arc or thermal sources. Acoustic shock wave, pressure shock wave and shrapnel are potential hazards that should be considered as well. Once the hazards have been identified, a risk mitigation plan should be developed. Personnel working on electrical equipment should be specifically qualified through training specific to the work to be done. The scope of such additional training depends on the hazards associated with the equipment.

3.0 MODES OF WORK ON ELECTRICAL EQUIPMENT

Under normal operation of listed or approved electrical equipment, the user/operator is protected by engineering controls, including insulation, enclosures, barriers, grounds and other methods to prevent injury. When engineering controls are not yet in place, not approved, or removed for diagnostics, maintenance, or repair, the activity falls into one of the following categories:

- Mode 0 – Electrically-Safe Work Condition
- Mode 1 – Establishing an Electrically-Safe Work Condition
- Mode 3 – Energized Diagnostics and Testing
- Mode 4 – Energized Work

3.1 MODE 0 – ELECTRICALLY-SAFE WORK CONDITION

An electrically-safe work condition is a state in which the conductor(s) or circuit part(s) to be worked on, or near, have been: (1) disconnected and isolated from a hazardous energized source or parts; (2) locked/tagged out (or equivalent), in accordance with established standards; (3) tested to ensure the absence of voltage; and, (4) grounded, if determined necessary. All work on hazardous electrical systems shall^{D.4} be performed in an electrically-safe work

condition, unless it can be demonstrated that establishing an electrically-safe work condition is infeasible.

3.2 MODE 1 – ESTABLISHING AN ELECTRICALLY-SAFE WORK CONDITION

To achieve Mode 0, an electrically-safe work condition, a worker conducts Mode 1 work. If the Mode 1 process exposes the worker to any hazard, the activity should be covered by work control procedures, and a hazard analysis should be performed. The work is energized electrical work, as covered by Mode 1, until an electrically-safe work condition is achieved (Mode 0). To establish an electrically-safe work condition, a qualified person should use the following steps:

1. Determine all sources of electrical supply to the specific equipment.
2. Check applicable drawings, diagrams, and identification tags, including equipment specific lockout/tagout (LOTO) procedures.
3. Turn off equipment.
4. Don correct personal protective equipment (PPE) and establish barricades, as necessary, for access control.
5. Open the disconnecting means (e.g., plug, breaker, or disconnect device).
6. If possible, visually verify that the plug is fully removed, all blades of the disconnecting devices are fully open, or that draw-out type circuit breakers are withdrawn to the fully disconnected position.
7. If applicable, test the controls and attempt to restart the equipment.
8. Apply LOTO devices, ensure that the plug is in total control of the worker, or use other engineering controls (such as capture key control systems) that are permitted by LOTO regulations.
9. If grounds have not been applied, use a correctly rated voltmeter to test each normally energized conductor or circuit part to verify they are de-energized, (Note: for high-voltage or large capacitive systems using a correctly rated voltmeter may not be a safe procedure, therefore, skip this step for such systems and go to step 11).
10. If the possibility of induced voltages exists, apply grounds to the normally energized conductors or circuit parts before touching them.
11. If stored electrical energy exists (e.g., capacitors), discharge or remove the stored energy and apply grounds to the normally energized conductors.

3.3 MODE 2 – ENERGIZED DIAGNOSTICS AND TESTING

In Mode 2, measurements, diagnostics, testing, and observation of equipment functions are conducted with the equipment energized and with some, or all, of the normal protective barriers removed and interlocks bypassed. Verification of a safe condition with a voltage-rated instrument is covered by the Mode 1 process and is not considered Mode 2.

Work is considered Mode 2 if proper voltage-rated instruments are used to contact the energized conductors. If any portion of the worker's body passes the Restricted Approach Boundary, appropriate shock PPE should be worn. If any portion of the worker's body passes the Prohibited Approach Boundary this is considered Mode 3, Energized Work, and the appropriate controls should be in place (see Section 3.4). If any portion of the worker's body passes the Arc Flash Boundary the appropriate arc flash PPE should be worn.

An approved work control document may be required (see individual tables in Section 3.6). Authorization by the worker's safety-responsible line manager is required. Some examples of Mode 2 operations are:

- Making voltage measurements with a multi-meter on energized components;
- Performing tests while working in close proximity to exposed energized components;
- Following manufacturer's instructions for diagnostics and troubleshooting of energized circuits; and
- Working on experimental facilities that operate in this mode.

3.4 MODE 3 – ENERGIZED WORK

Mode 3 operations involve physically moving energized conductors and parts, or moving parts that are near energized conductors (within the Prohibited Approach Boundary), and are conducted with the equipment fully energized and with some, or all, of the normal protective barriers removed.

Mode 3 work in hazard classification categories above X.0 and X.1 should be treated as an electrical hazard that should be permitted only when justified by a compelling reason. Tasks performed in this mode should be conducted under close supervision and control. Work control with an approved EEWP is required by NFPA 70E, 130.1(B)(1), with exceptions as indicated in the hazard classification tables.

Energized work shall^{D.5} be permitted only if:

- Additional or increased hazards would exist due to establishing an electrically-safe work condition;
- Equipment design or operational limitations make it infeasible to perform the work in a de-energized state; or
- If all exposed energized conductors and parts operate at 50 V or less with respect to ground.

An Energized Electrical Work Permit shall^{D.6} include, but not be limited to:

- A description of the circuit and equipment to be worked on and their location;
- Justification for why the work cannot be performed in a de-energized condition;
- A description of the safe work practices to be employed;
- Results of the shock hazard analysis;
- Determination of shock protection boundaries;
- Results of the arc hazard analysis;
- The arc flash protection boundary;
- The necessary PPE to safely perform the assigned task;
- Means employed to restrict the access of unqualified persons from the work area;
- Evidence of completion of a job briefing, including a discussion of any job-specific hazards; and

- Energized work approval (authorizing or responsible management, safety officer, owner, etc.).

4.0 APPROACH BOUNDARIES

The risk to a worker from an exposed electrical source of energy is determined by the proximity of the worker to the hazard. Electrical shock is a function of voltage, as air breakdown distances increase with higher voltages. Arc flash injury is determined by the distance that the arc flash energy, including ionized gas and metal, can injure the worker. Burn injury from contact with hot conductors has no boundary, as contact, or near contact, is necessary for injury.

There are three approach boundaries for shock protection:

- The Limited Approach Boundary;
- The Restricted Approach Boundary; and
- The Prohibited Approach Boundary.

As shown in Figure D-1, and as defined in Appendix B of the DOE Handbook for Electrical Safety (DOE-HDBK-1092-2013), these three boundaries are encountered as a worker approaches an exposed, energized electrical conductor.

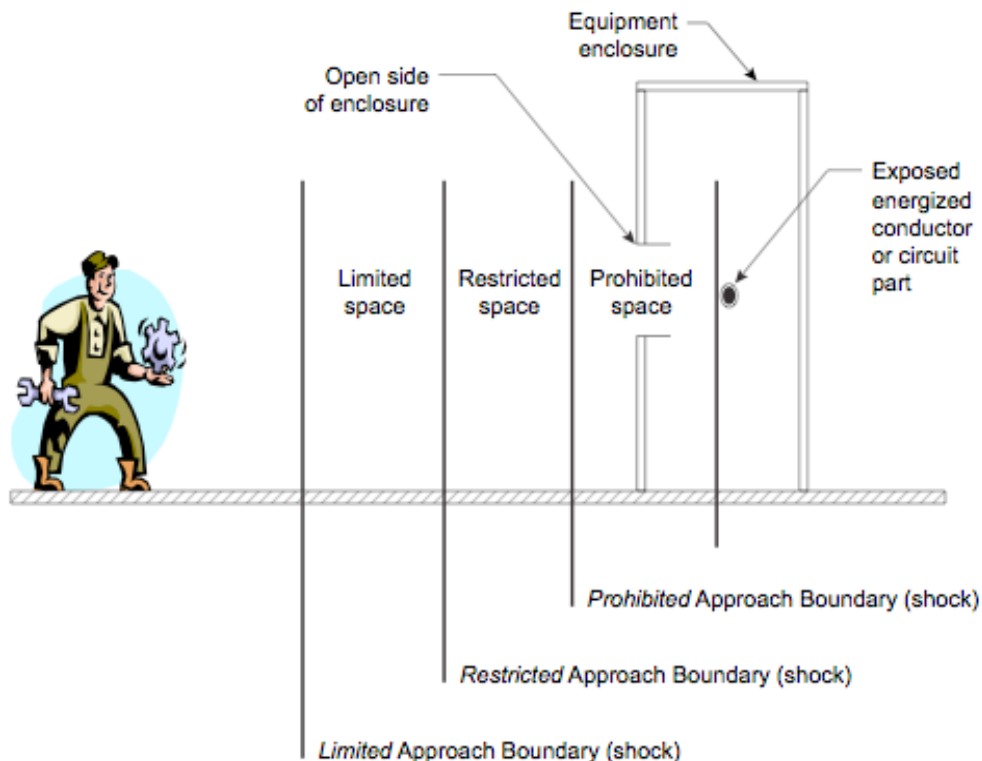

Fig. D-1. Approach boundaries for an exposed, energized conductor.

The arc flash boundary is the distance from an exposed, energized conductor that could result in a second degree burn to the worker, should an arc occur at that conductor. In general, the arc flash boundary is determined by the available fault current and the time to clear the fault, which determines the energy deposited into the arc. The arc flash boundary may be inside or outside the approach boundaries. Figure D-2 shows an arc flash boundary that is outside of the

Limited Approach Boundary, as is typical with many facility circuits, and Fig. D-3 shows an arc flash boundary that is inside the Prohibited Approach Boundary, as is common with many high-voltage, low-energy circuits.

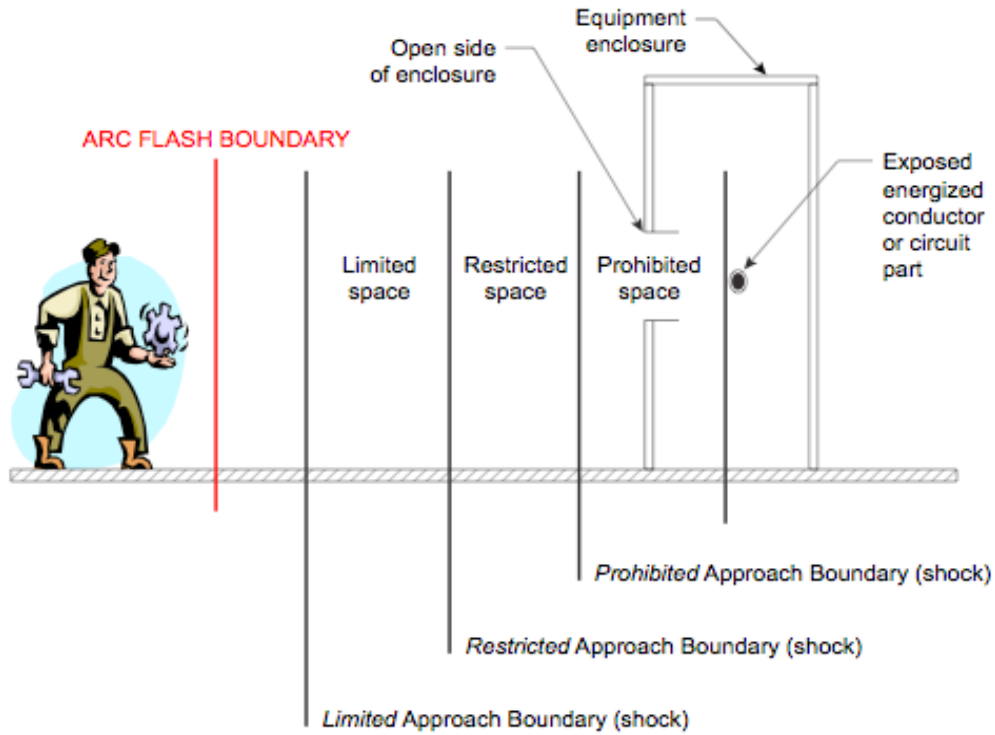

Fig. D-2. Arc flash boundary outside of the limited approach boundary.

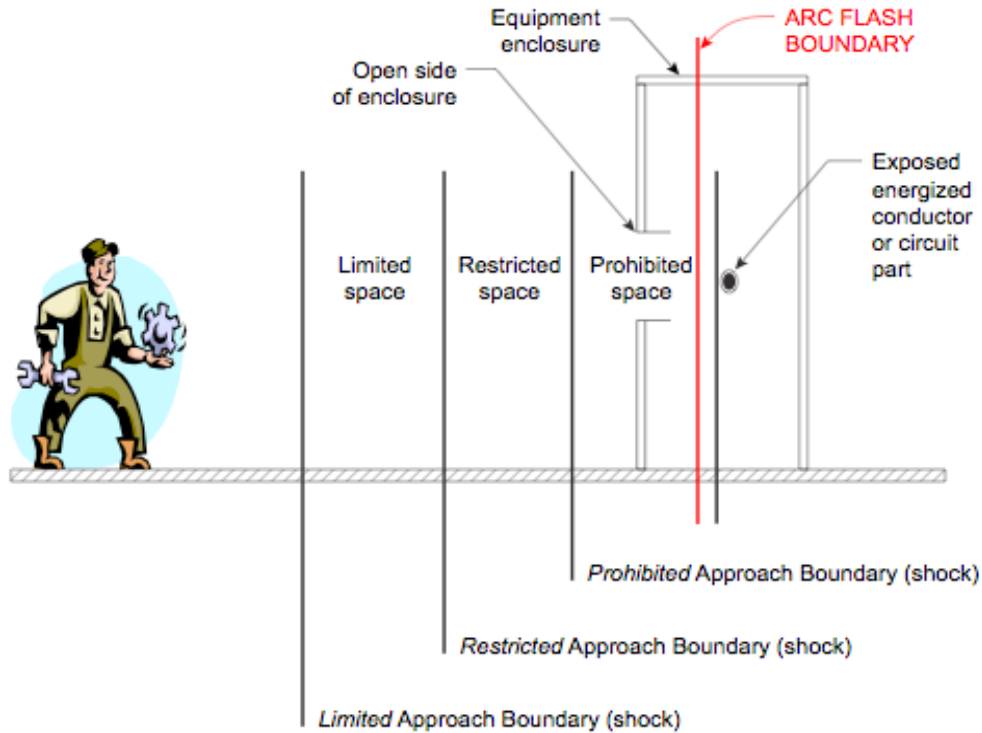

Fig. D-3. Arc flash boundary inside of the prohibited approach boundary.

Shock and arc flash boundary analysis should be completed before a person approaches nearer than a safe distance from an electrical hazard. For facilities, the principal reference for shock and arc flash boundary analysis is NFPA 70E, which covers facility shock and arc flash hazards. In addition, IEEE 1584, *Guide for Performing Arc Flash Hazard Calculations*, provides tools for calculating the arc flash boundary. Specialized system knowledge and methods may be necessary to calculate the shock and arc flash boundaries for some non-typical electrical equipment found in DOE workplaces, such as DC or capacitor systems, as methods are not available in existing codes and standards.

5.0 ELECTRICAL HAZARD ANALYSIS

5.1 APPROACH BOUNDARY ANALYSIS FOR 60 HZ AC

Approach boundary analysis (including the determination of the Limited, Restricted, and Prohibited Shock Boundaries) is based on the phase-to-phase voltage of the exposed conductor. Approach boundary tables are found in NFPA 70E for 60 Hz AC. Table D-4 is taken from NFPA 70E, Table 130.2(C).

(1) Nominal System Voltage Range, Phase-to-Phase	(2) Limited Approach Boundary		(4) Restricted Approach Boundary, Includes Inadvertent Movement Adder	(5) Prohibited Approach Boundary
	Exposed Movable Conductor	Exposed Fixed Circuit Part		
≤50	Not specified	Not specified	Not specified	Not specified
50–300	3.05 m (10'0")	1.07 m (3'6")	Avoid contact	Avoid contact
301–750	3.05 m (10'0")	1.07 m (3'6")	304.8 mm (1'0")	25.4 mm (0'1")
751–15 kV	3.05 m (10'0")	1.53 m (5'0")	660.4 mm (2'2")	178.8 mm (0'7")
15.1–36 kV	3.05 m (10'0")	1.83 m (6'0")	787.4 mm (2'7")	254 mm (0'10")
36.1–46 kV	3.05 m (10'0")	2.44 m (8'0")	838.2 mm (2'9")	431.8 mm (1'5")
46.1–72.5 kV	3.05 m (10'0")	2.44 m (8'0")	1.0 m (3'3")	660 mm (2'2")
72.6–121 kV	3.25 m (10'8")	2.44 m (8'0")	1.29 m (3'4")	838 mm (2'9")
138–145 kV	3.36 m (11'0")	3.05 m (10'0")	1.15 m (3'10")	1.02 m (3'4")
161–169 kV	3.56 m (11'8")	3.56 m (11'8")	1.29 m (4'3")	1.14 m (3'9")
230–242 kV	3.97 m (13'0")	3.97 m (13'0")	1.71 m (5'8")	1.57 m (5'2")
345–362 kV	4.68 m (15'4")	4.68 m (15'4")	2.77 m (9'2")	2.79 m (8'8")
500–550 kV	5.8 m (19'0")	5.8 m (19'0")	3.61 m (11'10")	3.54 m (11'4")
765–800 kV	7.24 m (23'9")	7.24 m (23'9")	4.84 m (15'11")	4.7 m (15'5")

Notes:

1. The symbol ' is used for feet and " for inches. Thus, 3'6" means 3 feet, 6 inches.
2. All dimensions are distance from live parts to worker.
3. Voltage, Phase-to-Phase refers to three-phase power systems. This value also can be used for phase-to-ground or conductor-to-ground voltage by multiplying the phase-to-ground voltage by 1.732.
4. Exposed Movable Conductor means that the bare conductor can move (e.g., an overhead transmission line conductor). This is unlikely indoors.
5. Exposed Fixed Circuit Part means the bare conductor or other circuit part is stationary and does not move. This is the most common Limited Approach Boundary value used.
6. The odd voltage ranges (e.g., 46–72 kV) were selected in NFPA 70E because of the typical voltages of utility transmission systems.
7. The odd distances in meters result from conversion of English system units to metric.
8. Boundary numbers are ≤ and >. For example, ≤50 V is not an AC shock hazard, >50 V is an AC shock hazard.

Table D-4. Approach boundaries to energized electrical conductors or circuit parts for shock protection, 60 Hz AC.

5.2 APPROACH BOUNDARY ANALYSIS FOR DC

Approach boundary values for DC are not found in NFPA 70E, 2009, the reference source at the time of the revision of the DOE Handbook for Electrical Safety. However, the information below is added from the 2012 edition of NFPA 70E for shock approach boundary for consideration. Differences in the physics of air gap break-down from 60 Hz AC to DC are small compared to the conservative values chosen for the boundaries. To determine a similar value for DC, the AC phase-to-phase voltage was converted to peak of a phase-to-ground. This would give a value that is 0.82 x value of the phase-to-phase voltage used in NFPA 70E 2012. The higher voltage values from NFPA 70E were used and are more conservative. Table D-5 gives approach boundaries to energized electrical conductors or circuit parts for DC, which are applicable to DC circuits, batteries, and capacitors. The notes help to explain the content and use of the table.

(1) Nominal Voltage Conductor to Ground	(3) Limited Approach Boundary Exposed Fixed Circuit Part	(4) Restricted Approach Boundary, Includes Inadvertent Movement Adder	(5) Prohibited Approach Boundary
≤100	Not specified	Not specified	Not specified
100–300	1.07 m (3'6")	Avoid contact	Avoid contact
300–1000 V	1.07 m (3'6")	304.8 mm (1'0")	25.4 mm (0'1")
1–5 kV	1.53 m (5'0")	450 mm (1'7")	100 mm (0'4")
5–15 kV	1.53 m (5'0")	660.4 mm (2'2")	178.8 mm (0'7")
15 kV–45 kV	2.5 m (8'0")	838.2 mm (2'9")	431.8 mm (1'5")
45 kV–75 kV	2.5 m (8'0")	1 m (3'2")	660.4 mm (2'2")
75 kV–150 kV	3 m (10'0")	1.2 m (4'0")	1 m (3'2")
150 kV–250 kV	4 m (11'8")	1.7 m (5'8")	1.6 m (5'2")
250 kV–500 kV	6 m (20'0")	3.6 m (11'10")	3.5 m (11'4")
500 kV–800 kV	8 m (26'0")	5 m (16'5")	5 m (16'5")

Notes:

1. The symbol ' is used for feet and " for inches. Thus, 3'6" means 3 feet, 6 inches.
2. All dimensions are distance from live parts to worker.
3. Voltage is conductor to ground.
4. Exposed Fixed Circuit Part means that the bare conductor or other circuit part is stationary and does not move.
5. The voltage ranges were simplified from NFPA 70E. Conservative values (e.g., the higher values) were chosen.
6. The distances were rounded up to generate simpler numbers.
7. Boundary numbers are ≤ and >. For example, ≤100 V is not a DC shock hazard, >100 V is a DC shock hazard.

Table D-5. Approach boundaries to energized electrical conductors or circuit parts for shock protection, DC.

5.3 FLASH HAZARD ANALYSIS FOR FACILITY POWER SYSTEMS

For facility power systems (i.e., Classes 1.2, 1.3, and 1.4) that are from 200 to 600 V, determine the Flash Protection Boundary as follows:

- Method 1: Calculate the Flash Protection Boundary using an appropriate method described in IEEE Std 1584a; include the clearing time considerations in §9.10.4. IEEE Std 1584a arc-flash calculations related to facility power systems should be performed under engineering supervision.

Note 1: § is a symbol for referring to a specific code section.

Note 2: An arc-fault is not self-sustaining below 200 V. Refer to §9.3.2 in IEEE Std 1584a.

Note 3: At locations immediately downstream of service entrance main circuit breakers and main circuit breakers in panel boards served by dry-type transformers, it is possible that the arc-fault current can be in the circuit breaker long-time trip band instead of the instantaneous trip region. (This is because that the arc-fault current is significantly less than the bolted fault current in low-voltage systems.) Such a condition could result in a great increase in the Flash Protection Boundary because of the long time delay before the circuit breaker trips (e.g., 30 seconds (s) instead of 0.015 s). Refer to §9.14 in IEEE Std 1584a.

- Method 2: Establish the Arc Flash Protection Boundary at 4' from the source of the arc only if the system meets one of the following criteria:
 - The available bolted fault current does not exceed 50 kA and the clearing time of the circuit protective device does not exceed 2 cycles; or
 - The product of the bolted fault current and clearing time does not exceed 100 kA-cycles.

Questions regarding the use of these methods should be referred to the AHJ.

5.4 FLASH HAZARD ANALYSIS FOR R&D SYSTEMS (SUPPLEMENT R&D)

Engineering supervision should be used to determine the DC arc flash boundary.

For R&D, capacitor, and battery systems, the work team should consider that an arc-flash hazard potentially exists and perform a flash hazard analysis using either NFPA 70E or IEEE 1584a should be used.

5.5 ELECTRICAL HAZARD ANALYSIS FOR MULTIPLE HAZARDS

Electrical hazards can be compounded by work involving mixed hazards. Examples include: (1) performing electrical work in confined spaces; (2) work involving arc-flash hazards and requiring breathing apparatus, such as respirators; and, (3) work involving arc-flash hazards and chemical or radiological hazards requiring anti-contamination PPE, and/or work in a clean room with arc-flash hazards. This document does not contain the prescriptive methods, tools, and controls for such work. It is important that each case be analyzed by the appropriate subject matter experts (SME) and that controls are developed to protect the workers, or that the work is changed to remove one or more of the hazards as necessary.

6.0 ADMINISTRATIVE CONTROLS FOR ELECTRICAL WORK

Administrative controls to mitigate electrical hazards can be divided into four basic categories:

1. Worker rules:
 - The working alone rule;
 - The two-person rule; and
 - The safety watch rule
2. Qualification and training.
3. Work control (including EEWP).
4. Personal protective equipment.

Each is addressed in the following sections.

6.1 WORKING ALONE, TWO-PERSON, AND SAFETY WATCH PRACTICES

Some DOE sites use two-person and safety watch rules to provide a second person in case of emergency, or to provide a "second set of eyes." Each electrical safety task should be analyzed to determine if the risk of injury to a worker, while working alone, warrants a second person to be present.

If the hazard analysis concludes the need for a second person, the second person should be a worker qualified to work on energized circuits, and should understand the work activities and the hazards present. According to NFPA 70E, 110.6(C), the second person shall be trained to know what to do in case of an electrical accident involving the other worker.

A safety watch is a more stringent hazard control measure than the two-person practice and should be implemented when there are grave consequences from a failure to follow safe work procedures. The safety watch should be a worker qualified to work on energized circuits who accepts responsibility for monitoring qualified worker(s) performing high-hazard electrical work.

6.2 QUALIFICATION AND TRAINING

See Section 2.7 of the DOE Handbook for Electrical Safety for a detailed description of training and qualifications.

6.3 WORK CONTROL

All hazardous electrical work should follow documented work control procedures. The electrical hazard classification control tables specify when an EEWP is required.

6.4 PERSONAL PROTECTIVE EQUIPMENT

Shock protection PPE is required whenever any portion of the worker's body passes the Restricted Approach Boundary. Arc flash PPE is required whenever any portion of the worker's body passes the Arc Flash Boundary. Recommended use of shock and arc flash PPE are given for each of the four modes of work on electrical equipment for each of the electrical hazard classes. In a few special cases, additional PPE may be necessary (e.g., for capacitor discharging, or for working on lead acid batteries).

7.0 HAZARD ASSESSMENT TABLES AND RECOMMENDED CONTROLS

The hazard classification charts cover eight broad categories: 60 Hz, DC, capacitors, batteries, Sub-RF, RF, inductors, and photovoltaic. Figure D-4 shows these eight major categories with a pointer to the figure where each category is broken into the individual classes. These classes, taken collectively, represent the electrical hazards found in electrical equipment. All classes should be considered when identifying the hazards associated with any piece of electrical equipment. A single piece of equipment may have multiple electrical hazard classifications, and the combination of hazards should be addressed by appropriate safety-related work practices. To aid hazard identification, each chart has cross-reference notes in the upper right hand corner. For example, the DC chart has cross-reference notes to capacitance, inductance, Sub-RF, battery, and 60 Hz hazard charts. Workers shall^{D.7} have a thorough understanding of the equipment they are analyzing for hazards. Consulting manuals and schematics and speaking with factory service representatives and electrical SMEs are ways to ensure that all of the hazards are fully understood and that all the pertinent classes are taken into account. Some guidelines on use of the hazard classification charts are provided, below. They are general, and there may be exceptions to each one:

- If these guidelines and the equipment are not understood, an SME should be consulted.
- All equipment gets its power from 60 Hz (Classes 1.x) or batteries (Classes 4.x). Thus, all equipment starts with one of those classes.
- Most small appliances, hand tools, and portable laboratory equipment plugs into Class 1.2. In general, if it can be carried, it most likely it uses 120 to 240 V.
- Larger facility and laboratory equipment may use up to 480 V (Class 1.3). Often, if it is a large motor, or consumes significant power, it may be Class 1.3.
- All electronic equipment, and much R&D equipment, converts facility power into DC. All DC power supplies have some capacitance. Thus, DC power supplies have hazards in Classes 2.x and 3.x. Both should be evaluated.
- All UPSs have hazards in Classes 4.x as well as 1.x, since they usually are tied into facility power (input), and produce facility type power (output).

The colors used in each hazard class box are organized in increasing hazard: blue, green, yellow, red, and maroon. Some general statements can be made about each color. There may be exceptions.



1. Light blue and white boxes are not hazard classes, but are decision points.



2. A blue class (X.0) indicates no hazard, and no engineering or administrative controls are needed.



3. A green class (X.1) indicates little to no hazards, few, or no, engineering or administrative controls are needed.



4. A yellow class (X.2) indicates injury or death could occur by close proximity or contact; often the hazard is shock or contact burn. Engineering controls are necessary for operation (e.g., listing or equipment approval), and administrative controls are necessary for electrical work in this class.



5. A red class (X.3) indicates injury or death could occur by proximity or contact; often the hazard is shock, contact burn, or arc-flash burn; engineering controls are necessary for operation (e.g., listing or equipment approval), and administrative controls are necessary for electrical work in this class.



6. Maroon class (X.4 and X.5) is the highest level of risk; significant engineering and administrative controls are necessary to manage the hazard in these classes.



7. Gray, class 3.1c, takes the user outside of electrical safety controls, as the primary hazard is chemical explosion.

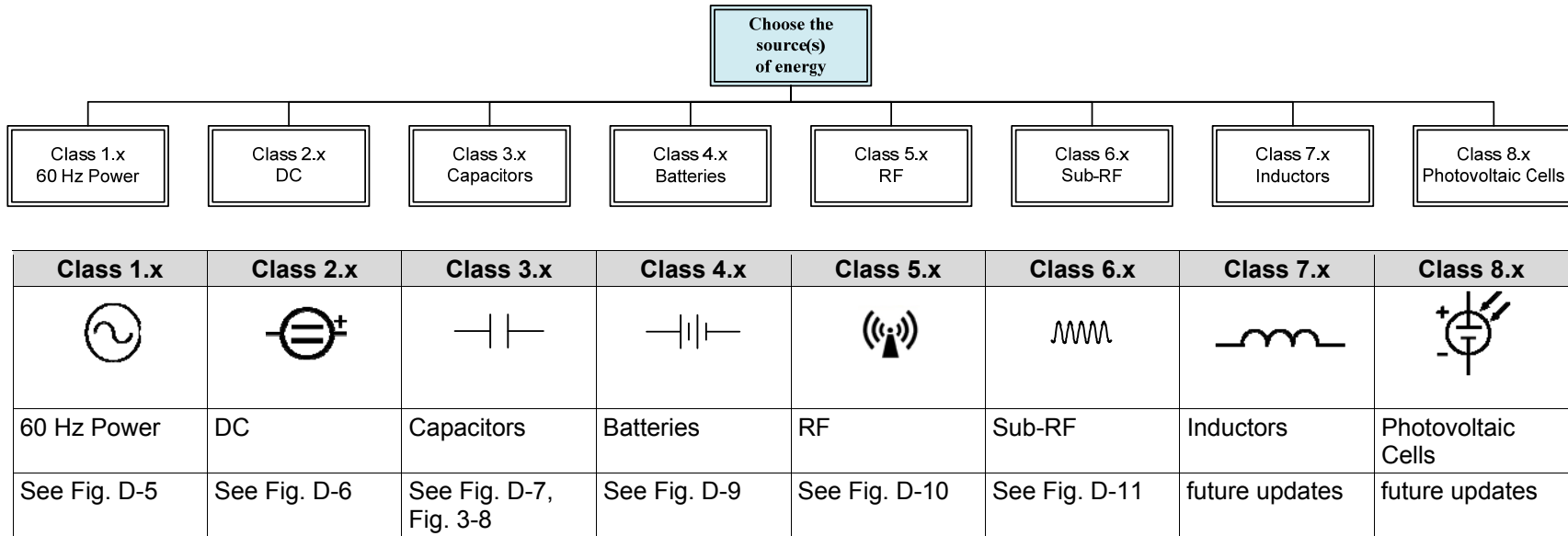









Fig. D-4. Complete Electrical Hazard Classification System Showing Eight Major Groups and 53 Classes.

Note: Throughout the following charts and tables, threshold numbers are \leq and $>$. For example, ≤ 50 V is not an AC shock hazard, > 50 V is an AC shock hazard.

DC		see Class 2.x
Capacitors		see Class 3.x
Batteries		see Class 4.x
RF		see Class 5.x
Sub-RF		see Class 6.x
Inductors		see Class 7.x
Photovoltaic Cells		see Class 8.x

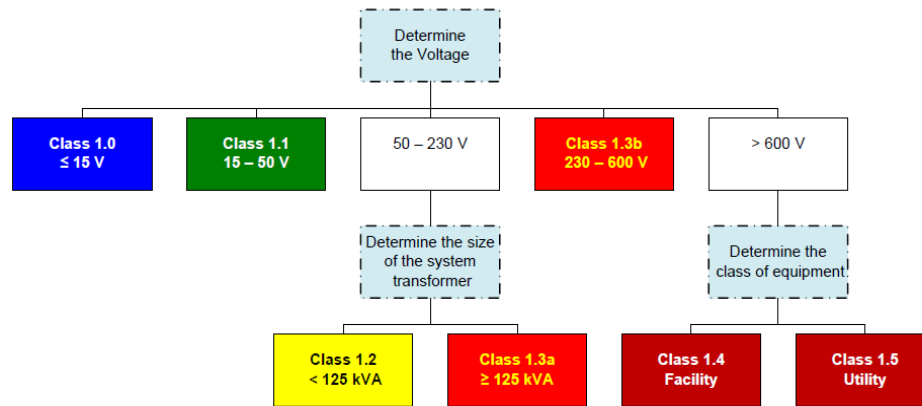









Fig. D-5. Hazard Classes 1.x, for 60 Hz Power.

Notes on use:

1. The voltage is the root mean square (rms) voltage.
2. For current limited 60 Hz circuits (≤ 5 mA), use hazard Class 6.x, Sub-RF.
3. The 125 kilovolt amperes (kVA) boundary between classes 1.2 and 1.3a, of < 125 kVA and ≥ 125 kVA is the only case in the document where the boundary is included in the higher class. This is driven by NFPA 70E. This applies to Fig. D-5 and Table D-6 only.

Table D-6. Control Table for Work in Hazard Classes 1.x					
Class	Mode	Qualified Worker(s)	Training	Work Control	PPE
1.0 ≤15 V	All	Alone	None	None	None
1.1 15–50 V	All	Alone	Non-Energized	None	None
1.2a 50–230 V <125 kVA	0	Alone	Non-Energized ¹	None	None
	1	Alone	Energized	YES	Shock Hazard Analysis ²
	2	Two Person ³	Energized	YES	Shock Hazard Analysis ²
	3 ⁴	Two Person	Energized	YES, EEWP	Shock Hazard Analysis ²
1.3a 50–230 V ≥125 kVA	0	Alone	Non-Energized ¹	None	None
	1	Two Person	Energized	YES	Shock Hazard Analysis and Flash Hazard Analysis ²
	2	Safety Watch	Energized	YES	Shock Hazard Analysis and Flash Hazard Analysis ²
	3 ⁴	Safety Watch	Energized	YES, EEWP	Shock Hazard Analysis and Flash Hazard Analysis ²
1.3b 230–600 V	0	Alone	Non-Energized ¹	None	None
	1	Two Person	Energized	YES	Shock Hazard Analysis and Flash Hazard Analysis ²
	2	Safety Watch	Energized	YES	Shock Hazard Analysis and Flash Hazard Analysis ²
	3 ⁴	Safety Watch	Energized	YES, EEWP	Shock Hazard Analysis and Flash Hazard Analysis ²
1.4 >600 V Facility	0	Alone	Non-Energized ¹	None	None
	1	Safety Watch	Energized	YES	Shock Hazard Analysis and Flash Hazard Analysis ²
	2	Safety Watch	Energized	YES	Shock Hazard Analysis and Flash Hazard Analysis ²
	3 ⁴	Safety Watch	Energized	YES, EEWP	Shock Hazard Analysis and Flash Hazard Analysis ²
1.5 >600 V Utility	0	Alone	Non-Energized ¹	YES	Shock Hazard Analysis and Flash Hazard Analysis ²
	1	Safety Watch	Lineman	YES	Shock Hazard Analysis and Flash Hazard Analysis ²
	2	Safety Watch	Lineman	YES	Shock Hazard Analysis and Flash Hazard Analysis ²
	3 ⁴	Safety Watch	Lineman	YES	Shock Hazard Analysis and Flash Hazard Analysis ²
¹ LOTO training is required for any worker who places a personal locking device to control hazardous energy while performing work. ² Perform a shock hazard analysis and/or flash hazard analysis using methods covered in Section D-5. ³ Mode 2 in Class 1.2 may be performed alone, if proper dielectric gloves are worn. ⁴ This mode of work should be avoided.					

60 Hz Power		see Class 1.x
Capacitors		see Class 3.x
Batteries		see Class 4.x
RF		see Class 5.x
Sub-RF		see Class 6.x
Inductors		see Class 7.x
Photovoltaic Cells		see Class 8.x

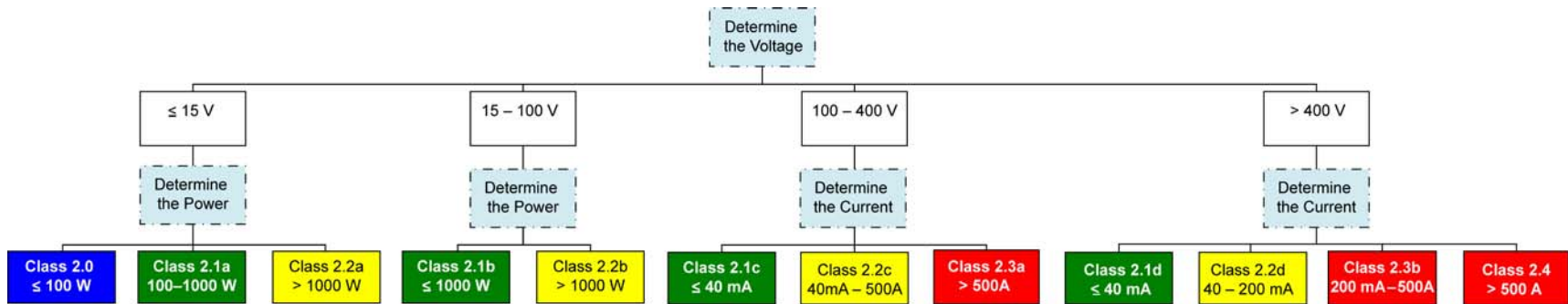

Fig. D-6. Hazard Classes 2.x, DC.

Notes on use:

1. The voltage is the DC voltage.
2. Power is available short-circuit power.
3. Current is available short-circuit current.

DOE-HDBK-1092-2013

Table D-7. Control Table for Work in Hazard Classes 2.x					
Class	Mode	Qualified Worker(s)	Training	Work Control	PPE
2.0 ≤15 V, ≤100 W	All	Alone	None	None	None
1. 2.1a,b,c,d 2. ≤100 V, ≤1 kWor 3. >100 V, ≤40 mA	All	Alone	Non-Energized	None	None
2.2a ≤15 V >1 kW	0	Alone	Non-Energized ¹	None	None
	1	Alone	Energized, HVCPS ²	YES	Insulated tools, gloves
	2	Two Person	Energized, HVCPS ²	YES	Insulated tools, gloves
	3 ³	Safety Watch	Energized, HVCPS ²	YES, EEWP	Insulated tools, gloves
2.2b 15–100 V >1 kW	0	Alone	Non-Energized ¹	None	None
	1	Alone	Energized, HVCPS ²	YES	Insulated tools, gloves
	2	Two Person	Energized, HVCPS ²	YES	Insulated tools, gloves
	3 ³	Safety Watch	Energized, HVCPS ²	YES, EEWP	Insulated tools, gloves
2.2c 100–400 V 40 mA–500 A	0	Alone	Non-Energized ¹	None	None
	1	Alone	Energized, HVCPS ²	YES	Shock Hazard Analysis ⁴
	2	Two Person	Energized, HVCPS ²	YES	Shock Hazard Analysis ⁴
	3 ³	Safety Watch	Energized, HVCPS ²	YES, EEWP	Shock Hazard Analysis ⁴
2.2d >400 V 40–200 mA	0	Alone	Non-Energized ¹	None	None
	1	Alone	Energized, HVCPS ²	YES	Shock Hazard Analysis ⁴
	2	Two Person	Energized, HVCPS ²	YES	Shock Hazard Analysis ⁴
	3 ³	Safety Watch	Energized, HVCPS ²	YES, EEWP	Shock Hazard Analysis ⁴
2.3a 100–400 V >500 A	0	Alone	Non-Energized ¹	None	None
	1	Two Person	Energized, HVCPS ²	YES	Shock and Flash Hazard Analysis ⁴
	2 ⁵	Safety Watch	Energized, HVCPS ²	YES	Shock and Flash Hazard Analysis ⁴
	3 ³	Safety Watch	Energized, HVCPS ²	YES, EEWP	Shock and Flash Hazard Analysis ⁴
2.3b >400 V 200 mA–500 A	0	Alone	Non-Energized ¹	None	None
	1	Two Person	Energized, HVCPS ²	YES	Shock Hazard Analysis ⁴
	2 ⁵	Safety Watch	Energized, HVCPS ²	YES	Shock Hazard Analysis ⁴
	3 ³	Safety Watch	Energized, HVCPS ²	YES, EEWP	Shock Hazard Analysis ⁴
2.4 >400 V >500 A	0	Alone	Non-Energized ¹	None	None
	1	Safety Watch	Energized, HVCPS ²	YES	Shock and Flash Hazard Analysis ⁴
	2 ³	Safety Watch	Energized, HVCPS ²	YES	Shock and Flash Hazard Analysis ⁴
	3 ³	Safety Watch	Energized, HVCPS ²	YES, EEWP	Shock and Flash Hazard Analysis ⁴

¹ LOTO training is required for any worker who places a personal locking device to control hazardous energy while performing work.
² HVCPS = High Voltage, High Current, and High Power Safety
³ This mode of work should be avoided.
⁴ Perform a shock hazard analysis and/or flash hazard analysis per Section D-5.
⁵ DO NOT move probes while energized.

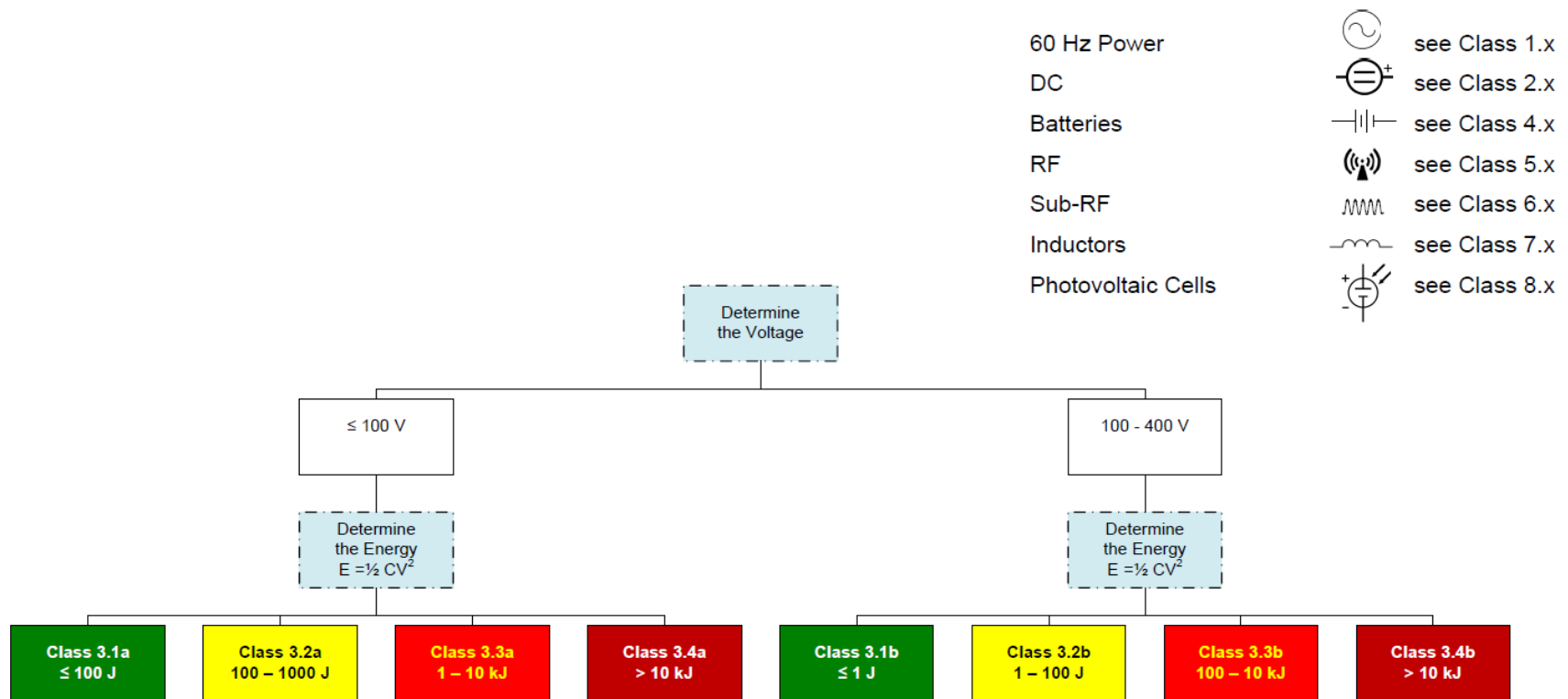

Fig. D-7. Hazard Classes 3.x, Capacitors, ≤400 V.

Notes on use:

1. Voltage is peak of the AC_{rms} or DC maximum charge voltage on the capacitor.
2. Energy is maximum energy stored in the capacitor as determined by $E = \frac{1}{2} CV^2$.
3. The hazards for less than 100 V, Classes 3.2a, 3.3a, 3.4a, are high current through a short circuit, such as tools and jewelry.
4. The hazards for 100 – 400 V, Classes 3.2b, 3.3b, 3.4b, are high current through a short circuit, and a shock hazard.
5. Class 3.4b has an added hazard of mechanical damage due to high currents and strong pulsed magnetic forces during a short circuit.

DOE-HDBK-1092-2013

Table D-8. Control Table for Work in Hazard Classes 3.x (≤400 V)						
Class	Mode	Qualified Worker(s)	Training	Work Control	PPE	Energy Removal
3.1a ≤100 V ≤100 J	All	Alone	Non-Energized	None	None	
3.1b 100–400 V ≤1 J	All	Alone	Non-Energized	None	None	
3.2a ≤100 V 100 J–1 kJ	0	Alone	Non-Energized ¹	None	None	
	1	Alone	Energized, HVCPS ²	YES	Eye, No Jewelry	Hard Ground Hook
	2	Two Person	Energized, HVCPS ²	YES	Eye, No Jewelry	
	3	Two Person	Energized, HVCPS ²	YES	Eye, No Jewelry	
3.2b 100–400 V 1–100 J	0	Alone	Non-Energized ¹	None	None	
	1	Alone	Energized, HVCPS ²	YES	shock ³	Hard Ground Hook
	2	Two Person	Energized, HVCPS ²	YES	shock ³	
	3	Two Person	Energized, HVCPS ²	YES, EEWP	shock ³	
3.3a ≤100 V 1–10 kJ	0	Alone	Non-Energized ¹	None	None	
	1	Two Person	Energized, HVCPS ²	YES	Eye, No Jewelry	Soft Ground Hook
	2	Two Person	Energized, HVCPS ²	YES	Eye, No Jewelry	
	3	Safety Watch	Energized, HVCPS ²	YES, EEWP	Eye, No Jewelry	
3.3b 100–400 V 100 J–10 kJ	0	Alone	Non-Energized ¹	None	None	
	1	Two Person	Energized, HVCPS ²	YES	Eye, shock ³	Hard Ground Hook
	2	Two Person	Energized, HVCPS ²	YES	Eye, shock ³	
	3 ⁴	Safety Watch	Energized, HVCPS ²	YES, EEWP	Eye, shock ³	
3.4a ≤100 V >10 kJ	0	Alone	Non-Energized ¹	None	None	
	1	Safety Watch	Energized, HVCPS ²	YES	Eye, No Jewelry	Remotely
	2 ⁵	Safety Watch	Energized, HVCPS ²	YES	Eye, No Jewelry	
	3 ⁴	Safety Watch	Energized, HVCPS ²	YES, EEWP	Eye, No Jewelry	
3.4b 100–400 V >10 kJ	0	Alone	Non-Energized ¹	None	None	
	1	Safety Watch	Energized, HVCPS ²	YES	Eye, Ear, shock ³ , arc flash ⁶	Remotely
	2 ⁵	Safety Watch	Energized, HVCPS ²	YES	Eye, Ear, shock ³ , arc flash ⁶⁶	
	3 ⁴	Safety Watch	Energized, HVCPS ²	YES, EEWP	Eye, Ear, shock ³ , arc flash ⁶⁶	

¹ LOTO training is required for any worker who places a personal locking device to control hazardous energy while performing work.
² HVCPS = High Voltage, High Current, and High Power Safety.
³ Determine by a shock hazard analysis, keep hands outside of Restricted Approach Boundary or wear appropriate dielectric PPE.
⁴ This mode of work should be avoided.
⁵ This mode of work should be avoided or done remotely.
⁶ Determine by a flash hazard analysis.

(a) Notes on use:

- PPE—eye is proper eye protection, either goggles or a face shield, for higher energies.
- PPE—no jewelry for low voltage capacitors, means no jewelry on the hands (e.g., rings, watches) and no dangling jewelry or other objects (e.g., badge).
- Column ‘Energy Removal’ is the method used to discharge lower-energy capacitors, or apply a safety ground on higher-energy capacitors. See definitions of hard and soft ground hooks.
- Performing ‘Energy Removal’ remotely means using engineering methods to discharge and verify the capacitors without worker exposure (e.g., a capacitor remote “dump” or discharge system).
- Performing Mode 2 remotely means using sensors and instruments that are placed during a Mode 0 condition, then observed from a safe location during Mode 2 work.

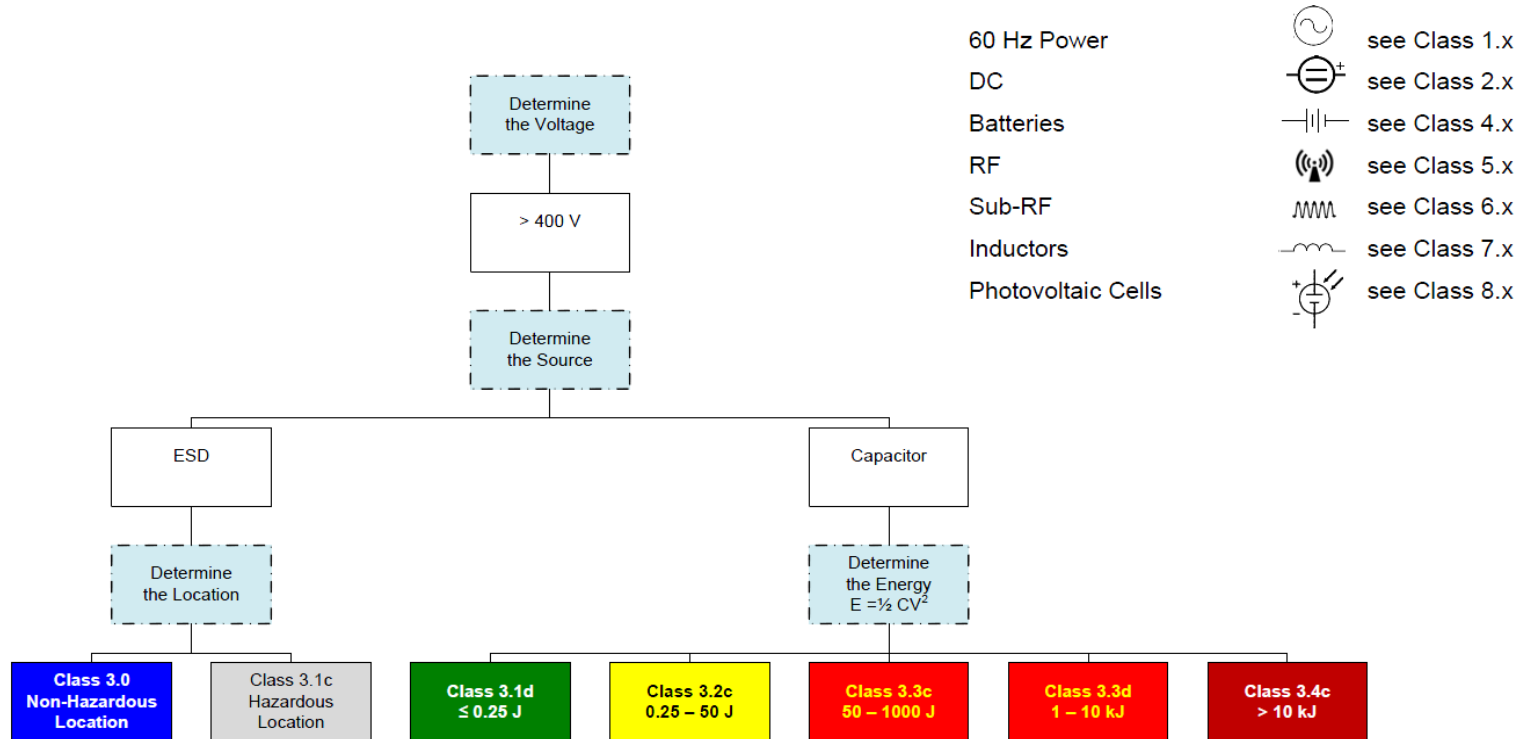

Fig. D-8. Hazard Classes 3.x, Capacitors, >400 V.

Notes on use:

1. Voltage is peak of the AC_{rms} or DC maximum charge voltage on the capacitor.
2. Energy is maximum energy stored in the capacitor as determined by $E = \frac{1}{2} CV^2$.
3. The hazards for greater than 400 V, Classes 3.2c, 3.3c, 3.3d, 3.4c are high current through a short circuit, and a shock hazard with a strong reflex action for Class 3.2c, and serious tissue injury and/or death for 3.3c and above.
4. Class 3.3d and 3.4c have the added hazards of mechanical damage due to high currents and strong pulse magnetic forces during a short circuit.
5. For Class 3.1c, the hazard is not electrical; refer to an explosive or hazardous location SME to manage the hazard.

DOE-HDBK-1092-2013

Table D-9. Control Table for Work in Hazard Classes 3.x (>400 V)						
Class	Mode	Qualified Worker(s)	Training	Work Control	PPE	Energy Removal
3.0-ESD	All	Alone	None	None	None	
3.1d >400 V ≤0.25 J	All	Alone	Non-Energized	None	None	
3.1c ¹ -ESD Haz Loc	All					
3.2c >400 V 0.25-50 J	0	Alone	Non-Energized ²	None	None	
	1	Alone	Energized, HVCPS ³	YES	shock ⁴	Hard Ground Hook
	2 ⁵	Two Person	Energized, HVCPS ³	YES	shock ⁴	
	3	Two Person	Energized, HVCPS ³	YES, EEWP	shock ⁴	
3.3c >400 V 50-1000 J	0	Alone	Non-Energized ²	None	None	
	1	Safety Watch	Energized, HVCPS ³	YES	Eye, Ear, shock ⁴	Hard or Soft Ground Hook
	2 ⁵	Safety Watch	Energized, HVCPS ³	YES	Eye, Ear, shock ⁴	
	3 ⁷					
3.3d >400 V 1-10 kJ	0	Alone	Non-Energized ²	None	None	
	1	Safety Watch	Energized, HVCPS ³	YES	Eye, Ear, shock ⁴	Soft Ground Hook
	2 ⁵	Safety Watch	Energized, HVCPS ³	YES	Eye, Ear, shock ⁴	
	3 ⁷					
3.4c >400 V >10 kJ	0	Alone	Non-Energized ²	None	None	
	1	Safety Watch	Energized, HVCPS ³	YES	Eye, Ear, shock ⁴ , arc flash ⁸	Remotely
	2 ⁵	Safety Watch	Energized, HVCPS ³	YES	Eye, Ear, shock ⁴ , arc flash ⁸	
	3 ⁷					

¹ For Class 3.1c refer to explosive safety SME.

² LOTO training is required for any worker who places a personal locking device to control hazardous energy while performing work.

³ HVCPS = High Voltage, High Current, and High Power Safety.

⁴ Determine by a shock hazard analysis, keep hands outside of Restricted Approach Boundary or wear appropriate dielectric PPE.

⁵ This mode of work should be done remotely.

⁶ Do this mode of work remotely.

⁷ DO NOT do this mode of work.

⁸ Determine by a flash hazard analysis.

1. Notes on use:

1. PPE—eye is proper eye protection, either goggles or a face shield, for higher energies.
2. PPE—no jewelry for low voltage capacitors, means no jewelry on the hands (e.g., rings, watches) and no dangling jewelry or other objects (e.g., badge).
3. Column 'Energy Removal' is the method used to discharge lower-energy capacitors, or apply a safety ground on higher-energy capacitors. See definitions of hard and soft ground hooks.
4. Performing 'Energy Removal' remotely means using engineering methods to discharge and verify the capacitors without worker exposure (e.g., a capacitor remote "dump" or discharge system).
5. Performing Mode 2 remotely means using sensors and instruments that are placed during a Mode 0 condition, then observed from a safe location during Mode 2 work.

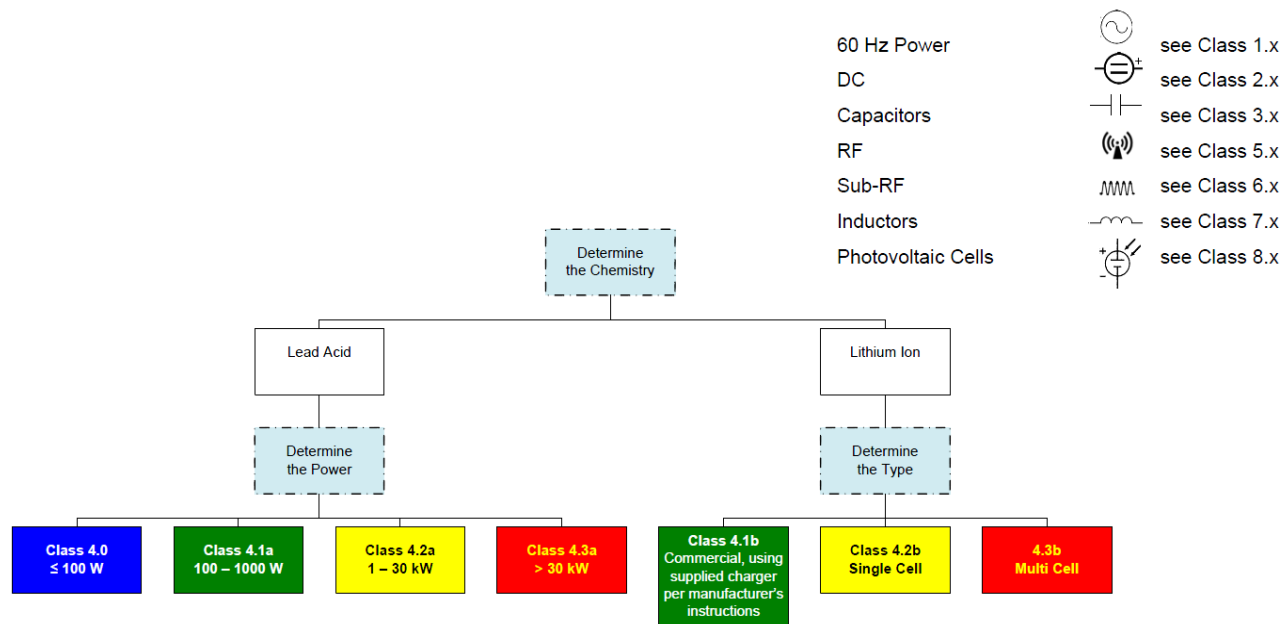

Fig. D-9. Hazard Classes 4.x, Batteries and Battery Banks.

Notes on use:

1. Power is the short circuit available power from the battery.
2. There can be no Mode 0 or 1 for batteries, as they are always energized.
3. Additional PPE is necessary for vented lead-acid batteries, depending on the work activity (e.g., chemical PPE).
4. Although all work on Class 4.2 (e.g., automotive batteries) is Energized Work, some of this work (e.g., jump starting cars) is commonly done by the public. Caution should be used, however, and appropriate training and controls in place.
5. Some class 4.2 batteries (e.g., desktop UPS batteries) may have adequate engineering controls, such as recessed terminals, to reduce the need for administrative controls.
6. For greater than 100 VDC, use hazard Classes 2.x to categorize the shock hazard.
7. For batteries and battery systems other than Lead Acid and Lithium Ion, use hazard Classes 2.x to categorize the shock hazard.

Table D-10. Control Table for Work in Hazard Classes 4.xa					
Class	Mode	Qualified Worker(s)	Training	Work Control	PPE
Lead Acid					
4.0 ≤100 W	All	Alone	None	None	None
4.1a 100–1000 W	All	Alone	Non-Energized	None	No Jewelry
4.2a 1–30 kW	2	Two Person	Non-Energized	YES	Eye, No Jewelry
	3	Safety Watch	Energized and Batteries	YES	Eye, No Jewelry
4.3a >30 kW	2	Safety Watch	Energized and Batteries	YES	Eye, No Jewelry
	3	Safety Watch	Energized and Batteries	YES	Eye, No Jewelry, Special Battery Tools
Notes on use:					
1. For greater than 100 VDC, use hazard Classes 2.x to categorize the shock hazard.					
2. For battery banks greater than 100 VDC, break up bank for energized work, when possible.					

Table D-11. Control Table for Work in Hazard Classes 4.xb					
Class	Mode	Qualified Worker(s)	Training	Work Control	Additional Controls
Lithium Ion					
4.1b Commercial	While Charging	Alone	None	Charge per manufacturer's instructions using the supplied charger.	None
4.2b ¹ Single Cell	While Charging	Alone	Non-Energized, Batteries	YES	None
4.3b ¹ Multi Cell	While Charging	Alone	Non-Energized, Batteries	YES	Containment, monitor temp using thermocouples
¹ Ensure, through AHJ equipment approval that the batteries and battery packs have integral protection and that the charging circuit is matched to the battery or battery pack.					
Notes on use:					
1. For greater than 100 VDC, use hazard Classes 2.x to categorize the shock hazard.					
2. For battery banks greater than 100 VDC, break up bank for energized work, when possible.					

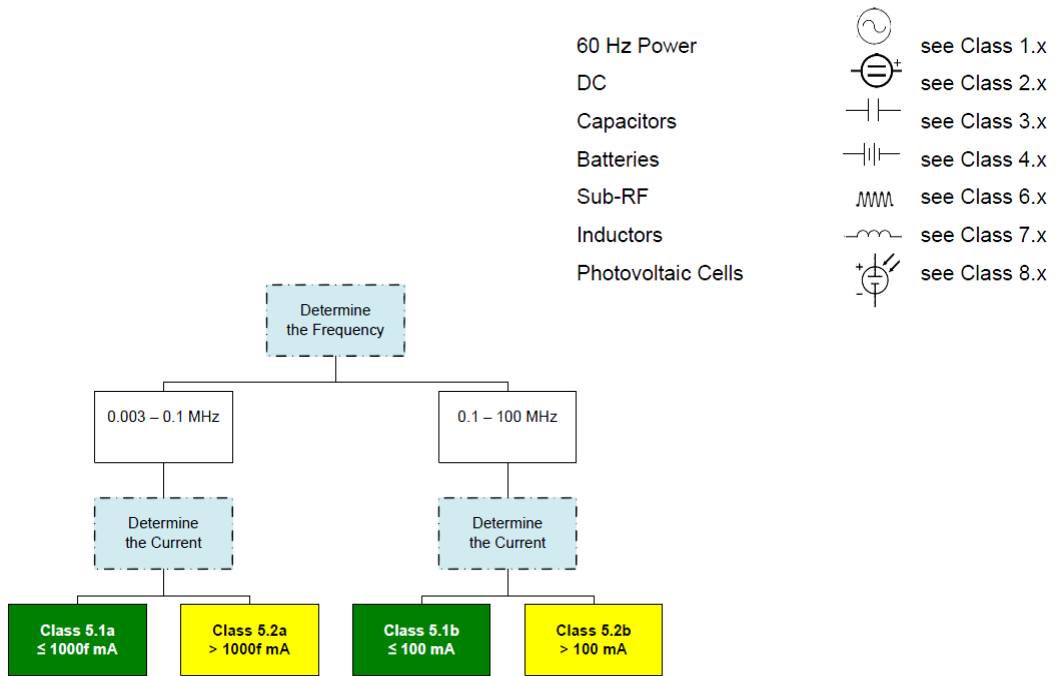

Fig. D-10. Hazard Classes 5.x, RF Circuits 3 kHz to 100 MHz (f is in MHz).

Table D-12. Control Table for Work in Classes 5.x

Class	Mode	Qualified Worker(s)	Training	Work Control	PPE
5.1a 0.003–0.1 MHz ≤1000f mA	All	Alone	None	None	None
5.1b 0.1–100 MHz ≤100 mA	All	Alone	None	None	None
5.2a 0.003–0.1 MHz >1000f mA	0	Alone	Non-Energized and NIRS	None	None
	1	To be determined	Energized and NIRS	Perform RF hazard analysis based on IEEE/ANSI C95.1	
	2				
	3				
5.2b 0.1–100 MHz >100 mA	0	Alone	Non-Energized and NIRS		
	1	To be determined	Energized and NIRS		
	2				
	3				
Notes on use:					
<p>1. f in the Chart is frequency in MHz.</p> <p>2. Classes 5.x and control Table ONLY address the RF shock hazard. They do NOT address the exposure to electromagnetic fields. IEEE/ANSI C95.1 covers the exposure to electromagnetic fields.</p> <p>3. NIRS = Non Ionizing Radiation Safety.</p> <p>4. The RF hazard classification chart in Fig. D-10 determines if the RF source can put out sufficient current to be a shock/burn hazard. However, it does not take into account the body impedance, which is necessary to determine if the source can drive these currents into the body. The tools for body impedance modeling are too detailed to put into this document.</p>					

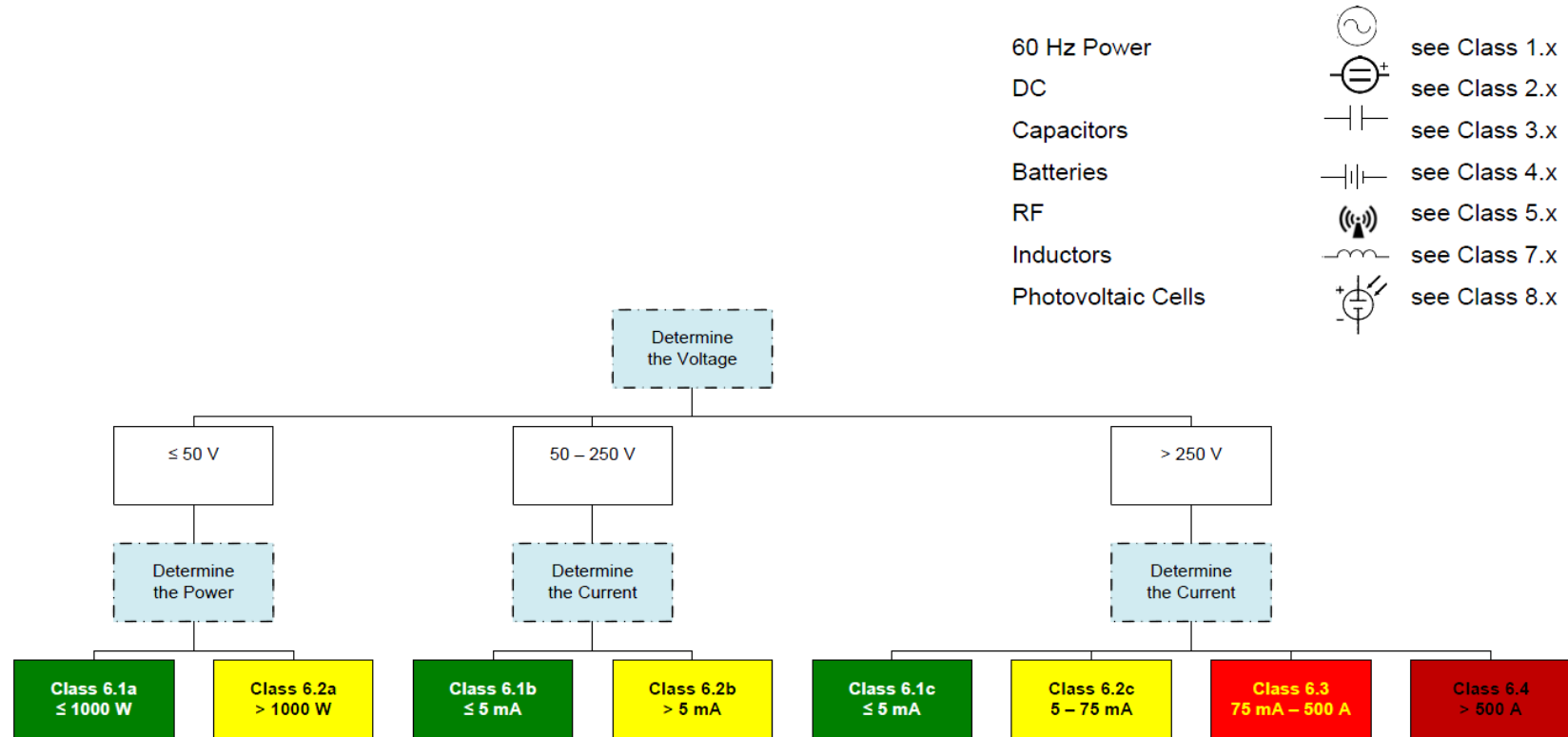

Fig. D-11. Hazard Classes 6.x, Sub-RF Circuits (1 kHz to 3 kHz).

Notes on use:

1. This hazard class is not to be used for 60 Hz power, except for power limited 60 Hz circuits that cannot have currents over 5 mA.
2. Power is available short-circuit power.
3. Current is available short-circuit current.

DOE-HDBK-1092-2013

Table D-13. Control Table for Work in Classes 6.x					
Class	Mode	Qualified Worker(s)	Training	Work Control	PPE
6.1a,b,c ≤50 V, ≤1 kW or >50 V, ≤5 mA	All	Alone	Non-Energized	None	None
6.2a ≤50 V >1 kW	0	Alone	Non-Energized ¹	None	None
	1	Alone	Energized and NIRS	YES	Insulated tools, gloves
	2	Two Person	Energized and NIRS	YES	Insulated tools, gloves
	3 ²	Safety Watch	Energized and NIRS	YES, EEWP	Insulated tools, gloves
6.2b 50–250 V >5 mA	0	Alone	Non-Energized ¹	None	None
	1	Alone	Energized and NIRS	YES	Shock Hazard Analysis ³
	2	Two Person	Energized and NIRS	YES	Shock Hazard Analysis ³
	3 ²	Safety Watch	Energized and NIRS	YES, EEWP	Shock Hazard Analysis ³
6.2c >250 V 5–75 mA	0	Alone	Non-Energized ¹	None	None
	1	Alone	Energized and NIRS	YES	Shock Hazard Analysis ³
	2	Two Person	Energized and NIRS	YES	Shock Hazard Analysis ³
	3 ²	Safety Watch	Energized and NIRS	YES, EEWP	Shock Hazard Analysis ³
6.3 >250 V 75 mA–500 A	0	Alone	Non-Energized ¹	None	None
	1	Safety Watch	Energized and NIRS	YES	Shock Hazard Analysis ³
	2 ⁴	Safety Watch	Energized and NIRS	YES	Shock Hazard Analysis ³
	3 ²	Safety Watch	Energized and NIRS	YES, EEWP	Shock Hazard Analysis ³
6.4 >250 V >500 A	0	Alone	Non-Energized ¹	None	None
	1	Safety Watch	Energized and NIRS	YES	Shock Hazard Analysis and Flash Hazard Analysis ³
	2 ²	Safety Watch	Energized and NIRS	YES	Shock Hazard Analysis and Flash Hazard Analysis ³
	3 ²	Safety Watch	Energized and NIRS	YES, EEWP	Shock Hazard Analysis and Flash Hazard Analysis ³
¹ LOTO training is required for any worker who places a personal locking device to control hazardous energy while performing work. ² This mode of work should be avoided. ³ Perform a shock hazard analysis and/or flash hazard analysis per Section 3-5. ⁴ DO NOT move probes while energized. NIRS = Non-Ionizing Radiation Safety.					

List of Acronyms

A	Ampere
AC	alternating current
AHJ	authority having jurisdiction
DC	direct current
DOE	Department of Energy
EEWP	energized electrical work permit
Hz	hertz
ISM	Integrated Safety Management
J	Joule
k	kilowatt
KHz	kilohertz
kVA	kilovoltampere
mA	milliamps/Milliamperes
MHz	megahertz
PPE	personal protection equipment
R&D	research and development
RF	radio frequency
RSM	root square means
UPS	uninterruptible power supply
V	volt

APPENDIX E REFERENCED REGULATION CITATIONS

Section 1	
1.1	10 CFR 850 and 851 Final Rule
1.2	10 CFR 851 Subpart A
1.3	OSHA 29 CFR 1910 and 1926 Subpart A
1.4	2009 NFPA 70E 110.7
1.5	10 CFR 851.11

Section 2	
2.1	2009 NFPA 70E
2.2	2009 NFPA 70E 205.1
2.3	2009 NFPA 70E 110.8(A)(1)
2.4	2009 NFPA 70E 120.2(A)
2.5	2009 NFPA 70E 120.2(B)(4)
2.6	2009 NFPA 70E 120.2(F)(2)(b)
2.7	2009 NFPA 70E 130.2(D)
2.8	2009 NFPA 70E 130.2(C)
2.9	2009 NFPA 70E 110.8(B)(1)
2.10	OSHA 29CFR 1910.303(a)
2.11	10 CFR 851.1(a)
2.12	10 CFR 851.10
2.13	2009 NFPA 70E 110.6
2.14	2009 NFPA 70E 110.6(B)
2.15	2009 NFPA 70E 110.6(E)
2.16	2009 NFPA 70E 110.6(D)(1)(b) and 1910.147(c)(7)(i)(A)
2.17	2008 NFPA 70 and OSHA 1910.303(g)(1)(i)
2.18	OSHA 29 CFR 1910.303(g)(1)(i)
2.19	2008 NFPA 70 110.26(A)(3)
2.20	2008 NFPA 70 110.26(A)(1)(b)
2.21	2008 NFPA 70 110.26(A)(2)
2.22	2008 NFPA 70 Table 110.26(A)(1)
2.23	2008 NFPA 70 Table 110.26(A)(1)
2.24	OSHA 1910.303(f)
2.25	2008 NFPA 70 240.24
2.26	OSHA 29CFR 1910.305(j)(4)(ii)(C)(1)
2.27	2009 NFPA 70E 130.7(F)
2.28	OSHA 29 CFR 1910.333(a)
2.29	2009 NFPA 70E 130.7(C)(1)
2.30	2009 NFPA 70E Table 130.7(C)(8)
2.31	2009 NFPA 70E 130.3
2.32	2009 NFPA 70E 130.7(C)(6)(c)
2.33	2009 NFPA 70E 130.7(D)(1)(3)
2.34	2009 NFPA 70E 130.7(C)(8)
2.35	2009 NFPA 70E Table 130.7(C)(6)(c)

DOE-HDBK-1092-2013

2.36	OSHA 29CFR 1910.269(j)(2)
2.37	OSHA 29CFR 1910.269
2.38	OSHA 29CFR 1910.269(j)(1)(i)
2.39	OSHA 29CFR 1910.269(j)(2)(iii)(E)(1)
2.40	OSHA 29CFR 1910.269(j)
2.41	2009 NFPA 70E 130.7(C)(6)(a)
2.42	2009 NFPA 70E 130.7(B)
2.43	2009 NFPA 70E 130.7(C)(7)
2.44	2009 NFPA 70E 120.2(F)(1)
2.45	OSHA 29 CFR 1910.147(c)(4)(ii)(B)
2.46	OSHA 29 CFR 1910.333(b)(2)(ii)(C)
2.47	OSHA 29 CFR 1910.333(b)(2)(ii)(D)
2.48	OSHA 29 CFR 1910.147(a)(3)
2.49	10 CFR 851.23(a)
2.50	OSHA 29 CFR 1910.333(b)(2)(iv)(B)
2.51	OSHA 29 CFR 1910.333(b)(2)(iv)(A)
2.52	2009 NFPA 70E 120.1(5)
2.53	2009 NFPA 70E 120.2(A), 130.7(C)(6)(a), and 130.7(C)(1)
2.54	2009 NFPA 70E 120.1(6)
2.55	OSHA 29 CFR 1910.333(b)(2)(v)
2.56	OSHA 29 CFR 1910.333(b)(2)(v)(A)
2.57	OSHA 29 CFR 1910.333(b)(2)(v)(B)
2.58	OSHA 29 CFR 1910.333(b)(2)(v)(C)
2.59	OSHA 29 CFR 1910.147(e)(3)i, ii, iii
2.60	2009 NFPA 70E 130.2(C)(2)
2.61	2009 NFPA 70E 110.6(D)(1)
2.62	2009 NFPA 70E 130.8(B)(1)
2.63	10 CFR 851 §22(b)
2.64	2009 NFPA 70E 130.7(F)
2.65	2009 NFPA 70E 130.1(B)(1)
2.66	2009 NFPA 70E 130.1(B)(3)
2.67	OSHA 29 CFR 1910.333(c)(2)
2.68	2009 NFPA 70E 130.6(D)
2.69	OSHA 29 CFR 1910.333(c)(4)
2.70	2009 NFPA 120.1(5)
2.71	2009 NFPA 70E 110.9(A)(3)
2.72	2009 NFPA 70E 110.9(A)(1)
2.73	2009 NFPA 70E 110.9(A)(2)
2.74	10 CFR 851.23(a)(14)

Section 4	
4.1	2009 NFPA 70E 205.1
4.2	OSHA 29 CFR 1926.404(b)(1)(i)
4.3	2008 NFPA 70 590.6(A)
4.4	2008 NFPA 70 590.6(B)

DOE-HDBK-1092-2013

4.5	2009 NFPA 70E 110.9(C)
4.6	2008 NEC 230.95(C)
4.7	2008 NEC 230.95
4.8	2009 NFPA 70E 205.3

Section 5	
5.1	2008 NFPA 70 250.66 and 250.64 (C)
5.2	2008 NFPA 70 250.124 and 250.134
5.3	2008 NFPA 70 250.4 (A)(5), 250.4 (B)(3), 250.96, and 250.122
5.4	2008 NFPA 70 250.4 (A)(5) and 250.4 (B)(4)
5.5	2008 NFPA 70 250.28 and 250.102
5.6	2008 NFPA 70 250.21 (A)(3)
5.7	2008 NFPA 70 250.4 (B)(1), 250.4 (B)(2), 250.4 (B)(3), and 250.4 (B) (4)
5.8	2008 NFPA 70 250.21 (B)
5.9	2008 NFPA 70 250.24 (C)
5.10	2008 NFPA 70 220.61(C)
5.11	2008 NFPA 70 250.36 and 250.186
5.12	2008 NFPA 70 250.20 (A)
5.13	2008 NFPA 70 250.20 (B)
5.14	2008 NFPA 70 Article 100
5.15	2008 NFPA 70 250.21
5.16	2008 NFPA 70 250.24 (B) and 250.28
5.17	2008 NFPA 70 250.28 (B)
5.18	2008 NFPA 70 250.28 (D)
5.19	2008 NFPA 70 250.24 (B)
5.20	2008 NFPA 70 250.24 (A)(5) and 250.142
5.21	2008 NFPA 70 250.24 (A)-(D)
5.22	2008 NFPA 70 250.64 (F)(1)
5.23	2008 NFPA 70 250.24 (C)(2)
5.24	2008 NFPA 70 300.3
5.25	2008 NFPA 70 250.4 (A)(5), 250.4 (B)(4), and 250.136 (A)
5.26	2008 NFPA 70 250.122
5.27	2008 NFPA 70 250.122 (F)
5.28	2008 NFPA 70 Table 250.122
5.29	2008 NFPA 70 250.122 (B)
5.30	2008 NFPA 70 250.122 (G)
5.31	2008 NFPA 70 300.3, 250.102 (E), 250.134, 250.24 (D), and 250.30 (A)
5.32	2008 NFPA 70 250.136 (A)
5.33	2008 NFPA 70 250.4 (B)
5.34	2008 NFPA 70 250.4 (B)(4)
5.35	2008 NFPA 70 250.4
5.36	2008 NFPA 70 250.30 (A)(1)
5.37	2008 NFPA 70 250.4 (A)
5.38	2008 NFPA 70 250.52
5.39	2008 NFPA 70 250.53 (C)

DOE-HDBK-1092-2013

5.40	2008 NFPA 70 250.52 (A)(1)
5.41	2008 NFPA 70 250.52 (A)(2)
5.42	2008 NFPA 70 250.52 (A)(3)
5.43	2008 NFPA 70 250.52 (A)(4)
5.44	2008 NFPA 70 250.52 (A)(5)
5.45	2008 NFPA 70 250.52 (A)(7)
5.46	2008 NFPA 70 250.52 (A)(8)
5.47	2008 NFPA 70 250.64 (F)(1)
5.48	2009 NFPA 70E 120.2(A)
5.49	OSHA 29 CFR 1910.269 (n)(4)
5.50	OSHA 29 CFR 1910.269 (n)(4)(i)
5.51	OSHA 29 CFR 1910.269 (n)(4)(ii)
5.52	OSHA 29 CFR 1910.269 (n)(6)
5.53	OSHA 29 CFR 1910.269 (n)(7)
5.54	OSHA 29 CFR 1910.269 (n)(5) and OSHA 29CFR 1910.269 (l)(6)

Section 6	
6.1	DOE M 440.1-1A, Revision 9F Chapter II Section 17.0, 17.2 p.
6.2	DOE M 440.1-1A, Revision 9F Chapter X Section 7.0, 7.0 a.
6.3	DOE M 440.1-1A, Revision 9F Chapter X Section 3.0, 3.3.1 a.
6.4	DOE M 440.1-1A, Revision 9F Chapter X Section 3.0, 3.5
6.5	DOE M 440.1-1A, Revision 9F Chapter X Section 7.0, 7.1 a.
6.6	DOE M 440.1-1A, Revision 9F Chapter II Section 7.0, 7.2 a.
6.7	DOE M 440.1-1A, Revision 9F Chapter II Section 7.0, 7.3 a.
6.8	DOE M 440.1-1A, Revision 9F Chapter II Section 7.0, 7.3 b.
6.9	DOE M 440.1-1A, Revision 9F Chapter II Section 7.0, 7.4 a.
6.10	DOE M 440.1-1A, Revision 9F Chapter II Section 7.0, 7.4 b.
6.11	DOE M 440.1-1A, Revision 9F Chapter II Section 7.0, 7.5 a.
6.12	DOE M 440.1-1A, Revision 9F Chapter II Section 7.0, 7.5 a(1).
6.13	DOE M 440.1-1A, Revision 9F Chapter II Section 7.0, 7.5 a(2).
6.14	DOE M 440.1-1A, Revision 9F Chapter II Section 7.0, 7.5 a(3).
6.15	DOE M 440.1-1A, Revision 9F Chapter II Section 7.0, 7.5 a(4).
6.16	DOE M 440.1-1A, Revision 9F Chapter II Section 7.0, 7.5 a(5).
6.17	DOE M 440.1-1A, Revision 9F Chapter II Section 7.0, 7.6 a.
6.18	DOE M 440.1-1A, Revision 9F Chapter II Section 7.0, 7.6 b.
6.19	DOE M 440.1-1A, Revision 9F Chapter II Section 7.0, 7.6 c.
6.20	DOE M 440.1-1A, Revision 9F Chapter II Section 7.0, 7.6 d.
6.21	DOE M 440.1-1A, Revision 9F Chapter II Section 7.0, 7.6 e.
6.22	DOE M 440.1-1A, Revision 9F Chapter II Section 8.0, 8.1 a.
6.22	DOE M 440.1-1A, Revision 9F Chapter II Section 8.0, 8.1 d(3).
6.24	DOE M 440.1-1A, Revision 9F Chapter II Section 8.0, 8.1 d(4).
6.25	2008 NFPA 70 110.20
6.26	DOE M 440.1-1A, Revision 9F Chapter II Section 8.0, 8.1 d(2).
6.27	DOE M 440.1-1A, Revision 9F Chapter II Section 8.0, 8.6 a(2).
6.28	2008 NFPA 70 500.7(D) & NFPA 496

DOE-HDBK-1092-2013

6.29	2008 NFPA 70 504 & 500.7(E)
6.30	DOE M 440.1-1A, Revision 9F Chapter II Section 8.0, 8.6 a(4).
6.31	DOE M 440.1-1A, Revision 9F Chapter II Section 8.0, 8.6 a(5).
6.32	DOE M 440.1-1A, Revision 9F Chapter II Section 8.0, 8.11 a.
6.33	DOE M 440.1-1A, Revision 9F Chapter II Section 8.0, 8.2 a(4).
6.34	DOE M 440.1-1A, Revision 9F Chapter II Section 8.0, 8.2 a(3).
6.35	DOE M 440.1-1A, Revision 9F Chapter II Section 8.0, 8.2 a(5).
6.36	DOE M 440.1-1A, Revision 9F Chapter II Section 8.0, 8.2 a.
6.37	DOE M 440.1-1A, Revision 9F Chapter II Section 13.0, 13.2.1 a.
6.38	DOE M 440.1-1A, Revision 9F Chapter II Section 13.0, 13.2.1 a(2).
6.39	DOE M 440.1-1A, Revision 9F Chapter II Section 13.0, 13.2.1 a(4).
6.40	DOE M 440.1-1A, Revision 9F Chapter II Section 13.0, 13.3.4.
6.41	DOE M 440.1-1A, Revision 9F Chapter II Section 13.0, 13.3.5 a.
6.42	DOE M 440.1-1A, Revision 9F Chapter II Section 13.0, 13.3.5 a(2).
6.43	DOE M 440.1-1A, Revision 9F Chapter II Section 13.0, 13.3.5 a(3).
6.44	DOE M 440.1-1A, Revision 9F Chapter II Section 13.0, 13.3.5 a(4).
6.45	DOE M 440.1-1A, Revision 9F Chapter II Section 13.0, 13.3.7 a.
6.46	DOE M 440.1-1A, Revision 9F Chapter II Section 13.0, 13.3.9 a.
6.47	DOE M 440.1-1A, Revision 9F Chapter II Section 13.0, 13.8.
6.48	DOE M 440.1-1A, Revision 9F Chapter II Section 13.0, 13.8.1 a.
6.49	DOE M 440.1-1A, Revision 9F Chapter II Section 13.0, 13.8.2 a.
6.50	DOE M 440.1-1A, Revision 9F Chapter II Section 13.0, 13.8.2 c.
6.51	DOE M 440.1-1A, Revision 9F Chapter II Section 13.0, 13.8.2 d.
6.52	DOE M 440.1-1A, Revision 9F Chapter II Section 13.0, 13.8.3 a.
6.53	DOE M 440.1-1A, Revision 9F Chapter II Section 13.0, 13.8.3 a(1).
6.54	DOE M 440.1-1A, Revision 9F Chapter II Section 13.0, 13.8.3 a(2).
6.55	DOE M 440.1-1A, Revision 9F Chapter II Section 13.0, 13.8.4 a.
6.56	DOE M 440.1-1A, Revision 9F Chapter II Section 13.0, 13.8.4 a(1).
6.57	DOE M 440.1-1A, Revision 9F Chapter II Section 13.0, 13.8.4 a(2).
6.58	DOE M 440.1-1A, Revision 9F Chapter II Section 13.0, 13.8.4 a(3).
6.59	DOE M 440.1-1A, Revision 9F Chapter II Section 8.0, 8.1 a.
6.60	2008 NFPA 70 504.30
6.61	2008 NFPA 70 501.105
6.62	2008 NFPA 70 505.7(A)
6.63	2008 NFPA 70 Article 100
6.64	2008 NFPA 70 501.15(F) and 505.16(E)
6.65	NEMA 250-2008 B.2.1.1
6.66	NEMA 250-2008 B.2.1.2
6.67	NEMA 250-2008 B.2.1.3
6.68	30 CFR 75.153

Section 7	
7.1	2008 NFPA 70 500.8
7.2	2008 NFPA 70 610.3 (B)
7.3	2008 NFPA 70 668.32 (A)

DOE-HDBK-1092-2013

7.4	2008 NFPA 70 668.32 (B)
7.5	2008 NFPA 70 610.31
7.6	2008 NFPA 70 610.32
7.7	2008 NFPA 70 610.61
7.8	2008 NFPA 70 250.12
7.9	2008 NFPA 70 610.55
7.10	2008 NFPA 70 110.26 (A); 610.57
7.11	2008 NFPA 70 725.41 (B)
7.12	OSHA 29 CFR 1910.179(g)(1)(ii)
7.13	OSHA 29 CFR 1910.179(g)(1)(iv)
7.14	OSHA 29 CFR 1910.179(g)(3)(viii)
7.15	OSHA 29 CFR 1910.179(g)(3)(i)
7.16	OSHA 29 CFR 1910.179(g)(3)(vii)
7.17	OSHA 29 CFR 1910.179(g)(3)(ix)
7.18	OSHA 29 CFR 1910.179(l)(1)
7.19	OSHA 29 CFR 1910.179(j)(2)
7.20	OSHA 29 CFR 1910.179(j)(2)(iii & iv)
7.21	OSHA 29 CFR 1910.333(c)(3)
7.22	OSHA 29 CFR 1910.333(c)(3)(i)(A)
7.23	OSHA 29 CFR 1910.269(p)(4)(ii)
7.24	2008 NFPA 70 620.11 (A)
7.25	2008 NFPA 70 620.12 (A)(2)
7.26	2008 NFPA 70 620.51
7.27	2008 NFPA 70 620.51 (D)
7.28	2008 NFPA 70 620.51 (A)
7.29	2008 NFPA 70 620.51 (B)
7.30	2008 NFPA 70 620.51 (C)
7.31	2008 NFPA 70 620.81
7.32	2008 NFPA 70 250.4, 620.82, 620.83
7.33	2008 NFPA 70 620.23 (C) & 620.24 (C)
7.34	2008 NFPA 70 590.6
7.35	2008 NFPA 70 250.34
7.36	2008 NFPA 70 480.9, NFPA 70E 320.4 (B)
7.37	2009 NFPA 70E 320.4 (A)
7.38	2009 NFPA 70E 320.4 (C)
7.39	2009 NFPA 70E 320.7 (F)(3)
7.40	2009 NFPA 70E 320.8
7.41	OSHA 29 CFR 1910.132
7.42	2009 NFPA 70E 320.9

Section 8	
8.1	OSHA 29 CFR 1910.268(h), CFR 1926.955 (a)(2)
8.2	OSHA 29 CFR 1910.269(a)(2)
8.3	NESC 421 A1 {C2-2007 NESC}
8.4	NESC 421 A2 {C2-2007 NESC}

DOE-HDBK-1092-2013

8.5	NESC 421(4) {C2-2007 NESC}
8.6	NESC 421 (b)(1) {C2-2007 NESC}
8.7	OSHA 29 CFR 1910.269(a)(2)(i)
8.8	OSHA 29 CFR 1910.269(2)(ii)(a)(b)(c)(d)
8.9	OSHA 29 CFR 1910.269 (c)
8.10	OSHA 29 CFR 1910.269(c)(1)
8.11	OSHA 29 CFR 1910.269(c)(2)
8.12	OSHA 29 CFR 1910.269(a)(2)(ii)(d)
8.13	OSHA 29 CFR 1910.135(a)
8.14	OSHA 29 CFR 1910.133(a)
8.15	OSHA 29 CFR 1910.269(l)(5)(iii)
8.16	OSHA 29 CFR 1910.137(a)
8.17	OSHA 29 CFR 1910.137(b)(2)(viii)
8.18	OSHA 29 CFR 1910.137(b)(2)(vii)
8.19	OSHA 29 CFR 1926.951(a)1(iii)
8.20	OSHA 29 CFR 1910.137(a)(1)(iii)
8.21	OSHA 29 CFR 1910.137(b)(2)(v)
8.22	OSHA 29 CFR 1910.269(j)(2)(iii)
8.23	OSHA 29 CFR 1910.269(j)(2)
8.24	OSHA 29 CFR 1910.137(b)(2)(iii)(e)
8.25	OSHA 29 CFR 1910.137(b)(2)(vi)
8.26	OSHA 29 CFR 1910.269(n)(3)
8.27	OSHA 29 CFR 1910.269(n)(2)
8.28	OSHA 29 CFR 1926.954(a)
8.29	OSHA 29 CFR 1910.269 Table R6 Note 2
8.30	OSHA 29 CFR 1910.269(n)(4)(i)
8.31	OSHA 29 CFR 1910.269(n)(4)
8.32	OSHA 29 CFR 1910.269(n)(6)
8.33	OSHA 29 CFR 1910.269(n)(5)
8.34	2009 NFPA 70E 120 (F)(2)(f)1
8.35	OSHA 29 CFR 1910.269(n)(7)
8.36	OSHA 29 CFR 1926.954(f)
8.37	OSHA 29 CFR 1910.269(n)(9)
8.38	NESC 443 (a)(1) {C2-2007 NESC}
8.39	NESC 443 (D) {C2-2007 NESC}
8.40	OSHA 29 CFR 1910.269(l)(i)
8.41	OSHA 29 CFR 1910.269(l)(4)
8.42	OSHA 29 CFR 1926.955 (e)
8.43	OSHA 29 CFR 1926.955(c)(2)
8.44	OSHA 29 CFR 1926.955(c)(3)
8.45	OSHA 29 CFR 1926.955(c)(4)(i)
8.46	OSHA 29 CFR 1926.955(c)(4)(ii)
8.47	OSHA 29 CFR 1926.955(c)(5)
8.48	OSHA 29 CFR 1926.955(c)(6)
8.49	OSHA 29 CFR 1926.955(c)(7)(i)

DOE-HDBK-1092-2013

8.50	OSHA 29 CFR 1926.955(c)(7)(ii)
8.51	OSHA 29 CFR 1926.955(c)(7)(iii)
8.52	OSHA 29 CFR 1926.955(c)(8)
8.53	OSHA 29 CFR 1926.955(c)(9)
8.54	OSHA 29 CFR 1926.955(c)(10)
8.55	OSHA 29 CFR 1926.955(d)(iii)
8.56	OSHA 29 CFR 1926.955(c)(11)(ii)
8.57	OSHA 29 CFR 1926.955(c)(12)(i)
8.58	OSHA 29 CFR 1926.955(d)
8.59	OSHA 29 CFR 1926.955(d)(9)
8.60	OSHA 29 CFR 1926.955(d)(2)
8.61	OSHA 29 CFR 1926.955(d)(3)
8.62	OSHA 29 CFR 1926.955(d)(4)
8.63	OSHA 29 CFR 1926.955(d)(5)
8.64	OSHA 29 CFR 1926.955(d)(8)(i)
8.65	OSHA 29 CFR 1926.955(d)(7)
8.66	NESC 2007 411.C.3{C2-2007 NESC}
8.67	NESC 2007 443.A.5{C2-2007 NESC}
8.68	OSHA 29 CFR 1926.955(a)(8)
8.69	OSHA 29 CFR 1910.269(r)(7)(vii)
8.70	OSHA 29 CFR 1910.269(r)(7)(ii)
8.71	OSHA 29 CFR 1910.146,1910.269(e) and (t), and 1926.956
8.72	OSHA 29 CFR 1910.269(e)(2)
8.73	OSHA 29 CFR 1910.269(e)(5)
8.74	OSHA 29 CFR 1926.956(a)(3)(ii)
8.75	OSHA 29 CFR 1926.956(b)(2)
8.76	OSHA 29 CFR 1910.146 and 1926.956
8.77	OSHA 29 CFR 1910.269(e)(14)
8.78	OSHA 29 CFR 1910.269(e)(12)
8.79	OSHA 29 CFR 1910.269(t)(3)
8.80	OSHA 29 CFR 1910.269(e)(7)
8.81	OSHA 29 CFR 1910.269(t)(1)
8.82	OSHA 29 CFR 1910.269(e)(8)
8.83	30 CFR 75.153
8.84	OSHA 29 CFR 1910.269(t)(8)
8.85	OSHA 29 CFR 1910.269(t)(5)
8.86	OSHA 29 CFR 1910.269(t)(7)
8.87	OSHA 29 CFR 1910.269(t)(6)

Section 9	
9.1	2008 NFPA 70 590.3(A)
9.2	2008 NFPA 70 590.3(D)
9.3	2008 NFPA 70 590.2(A)
9.4	2008 NFPA 70 590.2(A) & 300.19
9.5	2008 NFPA 70 310.8(C)

DOE-HDBK-1092-2013

9.6	2008 NFPA 70 406.8(A) & (B)
9.7	2008 NFPA 70 410.10(A)
9.8	2009 NFPA 70E 110.9(B)(3)(d)
9.9	OSHA 29 CFR 1926.405(g)(2)(v)
9.10	2008 NFPA 70 590.4(F)
9.11	OSHA 29 CFR 1926.405(a)(2)(ii)(F)
9.12	OSHA 29 CFR 1926.405(a)(2)(ii)(G)
9.13	2008 NFPA 70 590.4(D)
9.14	OSHA 29 CFR 1910.146
9.15	2009 NFPA 70E 110.9(B)(3)(b)
9.16	2008 NFPA 70 590.6
9.17	2008 NFPA 70 590.4(A)
9.18	2008 NFPA 70 590.4(B)
9.19	2008 NFPA 70 590.4(C)
9.20	2008 NFPA 70 590.6(B)(2)
9.21	OSHA 29 CFR 1926.302(e)(3)
9.22	2009 NFPA 70E 110.9(B)(1)
9.23	2009 NFPA 70E 110.9(B)(3)
9.24	OSHA 29 CFR 1926.405(a)(2)(ii)(J)
9.25	UL Standard 1097

Section 11	
11.1	2008 NFPA 70 250.4
11.2	2008 NFPA 70 250.6 (D)
11.3	2008 NFPA 70 250.6 (A)
11.4	2008 NFPA 70 250.6 (C)
11.5	2008 NFPA 70 250.4, 96,114,124
11.6	2008 NFPA 70 250.4, 8, 12, 119
11.7	2008 NFPA 70 250.4, 96 and 114
11.8	2008 NFPA 70 250.4 and 146
11.9	2008 NFPA 70 250.8 and 148 (E)
11.10	OSHA 29 CFR 1910.303(a),(b) Subpart S and 2008 NFPA 70 110.3 (b)
11.11	2008 NFPA 70 300.6,310, 400.3, 410.48 and 800.18
11.12	2008 NFPA 70 310 Tables
11.13	2008 NFPA 70 300.3(C)
11.14	2008 NFPA 70 300.4 and 400.14
11.15	2008 NFPA 70 110.12 and 110.27
11.16	2008 NFPA 70 300.4, 110.3 (B), 314.23(H), 400.10, 410.56 (A) (F), 410.62(C)(2) and 590.4 (H)
11.17	2008 NFPA 70 110.3(B)
11.18	2008 NFPA 70 400.3, 400.6, 400.9, 400.20 and 110.3 (B).
11.19	2008 NFPA 70 400.9
11.20	2008 NFPA 70 400.3, 310.15 and Table 310.15
11.21	2008 NFPA 70 300.4, 300.6 and 400.3
11.22	2008 NFPA 70 110.27 and 110.34

DOE-HDBK-1092-2013

11.23	2008 NFPA 70 90.4 and 110.3 (B)
11.24	2008 NFPA 70 110, 210, 300, 310, 400 and 406
11.25	2008 NFPA 70 406.6
11.26	2008 NFPA 70 250.124 (A)
11.27	2008 NFPA 70 406.7
11.28	2008 NFPA 70 240.5
11.29	2008 NFPA 70 90.4, 110.3 (B) and 406.6
11.30	2008 NFPA 70 110.27
11.31	2009 NFPA 70E 130.2(B)
11.32	2008 NFPA 70 110.9
11.33	2008 NFPA 70 240.8
11.34	OSHA 29 CFR 1910
11.35	2008 NFPA 70 210.4
11.36	OSHA 29 CFR 1910.269(d)(2)(ii)(B)(1) NFPA 70E
11.37	2008 NFPA 70 422.33 NFPA 70E
11.38	OSHA 29 CFR 1910.269(d)(2)(ii)(C)
11.39	2008 NFPA 70 110.21
11.40	2008 NFPA 70 110.27 and 1910.269(d)(2)(ii)(C)
11.41	2008 NFPA 70 110.34 (C)
11.42	2008 NFPA 70 110.21
11.43	2008 NFPA 70 110.26 and 110.34, see Figs. 11-4 and 11-5
11.44	2008 NFPA 70 392.5(B), 392.6, 392.7
11.45	2008 NFPA 70 392.3 and 392.10
11.46	2008 NFPA 70 300.8 and 392.3
11.47	2008 NFPA 70 392.3
11.48	2008 NFPA 70 392.9-13
11.49	2008 NFPA 70 300.8 and 392.3
11.50	2008 NFPA 70 392.5(C) and 110.3(B)
11.51	2008 NFPA 70 392.7
11.52	2008 NFPA 70 392.6(C)
11.53	2008 NFPA 70 110.27, 110.34, NFPA 70E
11.54	2008 NFPA 70 110.26, 110.31, 110.34
11.55	2008 NFPA 70 300.3 and 300.4
11.56	2008 NFPA 70 250.4 and 250.124(A)
11.57	2008 NFPA 70 250.4 (A)(5)

Section 12 All	
12.1	OSHA 29 CFR 1910.303(b) approval 2009 NFPA 70E 350.6

Section 13	
13.1	10 CFR 851.10(a)(1)
13.2	OSHA 29 CFR 1910.333(a)
13.3	2009 NFPA 70E 205.1 through 205.13
13.4	OSHA 29 CFR 1910.332(b)(2), OSHA 29 CFR 1910.332(b)(3), 2009 NFPA 70E 350.2

DOE-HDBK-1092-2013

13.5	2009 NFPA 70E 110.7(G)(1)
13.6	2008 NFPA 70 725, 29 CFR 1910.308(c)
13.7	2009 NFPA 70E 120.1(4)
13.8	2009 NFPA 70E 120.1(1)
13.9	2009 NFPA 70E 120.2(F)(2)(g)
13.10	2009 NFPA 70E 130.1(A)(3)
13.11	2009 NFPA 70E 130.2(A), 2009 NFPA 70E 130.2(C)(1), 2009 NFPA 70E 130.7(E)(2), OSHA 29 CFR 1910.335(1)(2)
13.12	2009 NFPA 70E 130.3(C)
13.13	2009 NFPA 70E 120.1, OSHA 29 CFR 1910.333(a)
13.14	2009 NFPA 70E 130.2, OSHA 29 CFR 1910.333(c)
13.15	2009 NFPA 70E 130.2, OSHA 29 CFR 1910.333(c)
13.16	2009 NFPA 70E 130.6(J), OSHA 29 CFR 1910.334(b)(1)
13.17	2009 NFPA 70E 350.5
13.18	2009 NFPA 70E 130.7(E)(1)
13.19	2009 NFPA 70E 130.2(D)(2)
13.20	21 CFR 1030.10(c)(2)
13.21	2008 NFPA 70 392.7(A)
13.22	2008 NFPA 70 Article 250
13.23	2008 NFPA 70 250.4(A)(2), 2008 NFPA 70 250.4(A)(3), 2009 NFPA 70E 110.9(B)(2)
13.24	2008 NFPA 70 250.4(A)(4), 2008 NFPA 70 250.4(A)(5)
13.25	2008 NFPA 70 501.30(A), 2008 NFPA 70 501.30(B)
13.26	2009 NFPA 70E 110.3, 2009 NFPA 70E 110.6(A), 10 CFR 851.25
13.27	2009 NFPA 70E 110.6(B), OSHA 29CFR 1910.331 through 1910.335
13.28	2008 NFPA 70 460.6(B)
13.29	2008 NFPA 70 460.6(A)
13.30	2009 NFPA 70E 120.1(6)
13.31	OSHA 29 CFR 1910.304(a)(1)
13.32	2009 NFPA 70E 205.1
13.33	2009 NFPA 70E 130.7(A)
13.34	2009 NFPA 70E 120.2(A), 2009 NFPA 70E 130.2(C), 2009 NFPA 70E 130.2(D)
13.35	2009 NFPA 70E 130.7(D)(1)(3)
13.36	2009 NFPA 70E 320.9(2)
13.37	2009 NFPA 70E 320.8(1) through NFPA 70E Article 320.8(5), NFPA 70E Article 130.7(D)(1)(2)
13.38	OSHA 29 CFR 1910.138(a)

Appendix C All NEC 2008 and 70E 2009 unless otherwise	
C.1	OSHA 29 CFR 1910.303(b) approval 2009 NFPA 70E 350.6
C.2	OSHA 29 CFR 1910.303(b) approval
C.3	2009 NFPA 70E (110.3)
C.4	OSHA 29 CFR 1910.303 (a) and (b) approval
C.5	OSHA 29 CFR 1910.303 (a) NEC 110.2
C.6	2008 NFPA 70 110.2

DOE-HDBK-1092-2013

C.7	OSHA 29 CFR 1910.303(a)
C.8	2008 NFPA 70 110.3(B)
C.9	OSHA 29 CFR 1910.332 NEC 100
C.10	OSHA 29 CFR 1910.303
C.11	2008 NFPA 70 250.4A(4)
C.12	2008 NFPA 70 400.10
C.13	2008 NFPA 70 240.22

Appendix D	
D.1	2009 NFPA 70E, 110.8(B)(1)
D.2	2009 NFPA 70E 110.8(A)(1) and 130.1(A) and OSHA 29 CFR 1910.333(a)(1)
D.3	2009 NFPA 70E 110.8(A) and OSHA 29 CFR 1910.333(a)
D.4	2009 NFPA 70E 110.8(A)(1) and 130.1(A)
D.5	2009 NFPA 70E 130.1(A) and OSHA 29 CFR 1910.333(a)(1)
D.6	2009 NFPA 70E 130.1(B)(2)
D.7	2009 NFPA 70E 110.6(D)(1)

APPENDIX F EXAMPLE OF A WAY TO MEASURE ELECTRICAL SEVERITY

Purpose: This example is intended to determine the severity of an electrical energy event based on an evaluation of a series of electrical factors. The primary factors include: electrical hazard, environment, shock proximity, arc flash proximity, thermal proximity and any resulting injury(s) to affected personnel.

Scope: This tool establishes a standardized approach for tracking and trending electrical energy events. Specifically this approach provides a method to determine the severity of an electrical event and to measure performance over a period of time. The Electrical Severity (ES) calculation is designed to be performed by an electrical subject matter expert (SME) with working knowledge of the Electrical codes and standards.

Limitations: This tool is not intended to evaluate events that do not involve a worker being exposed to electrical energy.

Note: Failure to establish an electrically-safe work condition (e.g., lockout/tagout) that results in the discovery of an incomplete isolation of hazardous electrical energy is considered exposed. This tool establishes a metric that can be consistently applied to allow an organization to compare relative performance against itself. Comparison of one organization's performance to another is considered inappropriate without further normalization due to anomalies and variables that may exist in work scope (e.g., decontamination and decommissioning vs. research and development (R&D), and, environmental conditions, etc.).

This tool is not intended to be used to develop electrical safety program requirements. The intent of this tool is to provide a relative ranking of the severity of the event to electrical hazards.

User Guidelines

- 1) This tool is not intended to cover all factors that contribute to an electrical event. For example, it does not take into account: (a) training; (b) work control (except for establishing an electrically-safe work condition and wearing proper personal protection equipment (PPE); and, (c) equipment maintenance. This tool is intended to give a relative rank of the severity of the injury, or potential for injury.

Consider only the data required by the Severity Equation.

- 2) This tool should be used without speculation on what could have occurred, or "what ifs." It is intended to give a quantitative, reproducible score of an event, no matter where or when it occurred. Ideally, this tool should give the same result regardless of the user.

Do not speculate about what "could have happened."

- 3) This tool is not intended to be the sole measure of the severity of a safety event, but to give a measure of the electrical hazard component. There may be other hazards involved (e.g., confined space, radiological), other issues (e.g., lack of training, lack of engineering controls), and other similar management concerns.

Other factors may need to be considered in the overall event assessment.

- 4) This tool gives a medium significance score for a dry hand, 120 volt (V) shock. Across the country, there are estimated to be 100s of dry hand, 120 V shocks daily while performing everyday activities, such as inserting a plug into a receptacle, especially across the fingers of one hand. It is very rare but possible that such shocks result in injury or fatality, anyway it is important to record them, to identify trends or concerns. The tool does take into account the factors that can cause such shocks to be harmful or fatal, such as a wet environment.

A dry-hand, 120 V shock ranks medium significance.

- 5) Equipment failures, containing the electrical hazard, do not result in a worker being exposed to an electrical hazard, thereby giving a score of zero. If the electrical energy escapes, such as no equipment ground in place, or inadequate arc flash containment, then a worker may be exposed if within the boundaries.

Equipment failures may not result in a worker being exposed to an electrical hazard.

Electrical Severity (ES)

Each electrical event is reviewed to determine its ES using the following equation:

Electrical Severity (ES) = (Electrical Hazard Factor) * (1 + Environment Factor + Shock Proximity¹ Factor + Arc Flash Proximity¹ Factor + Thermal Proximity¹ Factor) * (Injury Factor)

¹ Note there cannot be both an Arc Flash Proximity Factor and a Thermal Proximity Factor. If the proper PPE is used while performing the work, these factors can be reduced to zero (refer to PPE Mitigation section).

The ES is based on the following factors:

Electrical Hazard Factor	blue - no hazard	0
	green - low-hazard	1
	yellow - moderate hazard	10
	red - high-hazard	50
	maroon - very high-hazard	100

*The Electrical Hazard Factor is determined by classifying the source of electrical energy that the worker was exposed to during the event and then assigning a value to it, based on the **Electrical Hazard Classification Charts**² found in the back of this document and color coded as shown above. Failure to establish an electrically-safe work condition (e.g., lockout/tagout) resulting in the discovery of an incomplete isolation of hazardous electrical energy is considered an exposure. This **does not include** discoveries made by zero-energy checks before work is authorized or administrative errors.*

² The hazard classification charts cover six broad areas, AC 60 Hz (Chart 2), DC (Chart 3), capacitors (Charts 4 & 5), batteries (Chart 6), RF (Chart 7) and sub-RF (Chart 8). These charts, taken collectively, represent almost all of the electrical hazards found in electrical equipment. Consequently, all classes should be considered when identifying the hazards associated with any piece of electrical equipment. A single piece of equipment may have multiple electrical hazard classifications, and the worker may have been exposed to a combination of hazards. To aid hazard identification, each chart has cross-reference notes. For example, the DC chart has cross-reference notes to capacitance, battery, and AC 60 Hz. Event evaluators should have a thorough understanding of the equipment involved in the electrical event when performing the evaluation. Consulting manuals and schematics and speaking with factory service representatives and SMEs are ways to ensure that all of the hazards are fully understood and that all the pertinent classes are taken into account.

Environment Factor	Dry	0
	Damp	5
	Wet	10

The Environment Factor³ is determined by analyzing the environmental condition found in the area of the event. The Environment Factor is determined in order to assess the level of severity at the time of the event. Human skin resistance can vary considerably from a dry location to one that contains conductive fluids (e.g., end mill misters present in a machine shop). If the proper PPE is used while performing work, this factor can be reduced to zero (refer to the PPE Mitigation section).

³ Dry is indoors, unless otherwise noted. Damp is outdoors, unless otherwise noted. Wet is assumed when water, snow, or other conductive liquids are involved. Examples: Outdoors can be dry, in certain arid climates, and Indoors can be wet, in work conditions involving conductive fluids.

Shock Proximity Factor	Outside Limited Approach Boundary	0
	Within Limited Approach Boundary	1
	Within Restricted Approach Boundary	3
	Within Prohibited Approach Boundary	10

The Shock Proximity Factor is determined by performing a Shock Hazard Analysis. Table E-1 should be used to determine if there is a shock hazard, then determine the approach boundaries in Table E-2(AC 60 Hz) or Table E-3(DC), which are based on Table 130.2(C) of NFPA 70E. The factor is assigned, based on the approximate distance of the worker(s) to the exposed energy source. All dimensions are distance from the exposed live part to the employee. If the PPE is used while performing work, this factor can be reduced to zero (refer to the PPE Mitigation section).

Source	Includes	Thresholds
AC	60 Hz	> 50 V and > 5 mA
DC	all	> 100 V and > 40 mA
Capacitors	all	> 100 V and > 1 J, or > 400 V and > 0.25 J
Batteries	all	> 100 V
Sub-RF	1 Hz to 3 kHz	> 50 V and > 5 mA
RF	3 kHz to 100 MHz	A function of frequency

Table E-1. Thresholds for defining shock hazards.

Notes:

It is possible for a worker to be exposed to more than one shock hazard at any given location.

There may be other electrical hazards below the above shock thresholds (e.g., a thermal burn hazard). See the tables below.

Injuries may result from startle reactions due to contact with energized components, even though there is no shock hazard, especially high-voltage, low-energy.

Shock and burn hazards from induced and contact RF currents become negligible above 100 MHz.

Shock Boundary Analysis for 60 Hz

Shock boundary analysis, including the determination of the Limited, Restricted, and Prohibited Shock Boundaries, is based on the nominal system voltage range, phase-to-phase with the distance being from the exposed energized electrical conductor or circuit part to the employee. Shock boundary tables are found in NFPA 70E for 60 Hz power, and can be adapted to DC, including batteries and capacitors. Table E-2 is taken from NFPA 70E, Table 130.2(C) with some modifications. The notes help to explain the content and use of the table.

Nominal System Voltage Range, Phase-to-Phase	Limited Approach Boundary		Restricted Approach Boundary, Includes Inadvertent Movement Adder	Prohibited Approach Boundary
	Exposed Movable Conductor	Exposed Fixed Circuit Part		
≤ 50	Not specified	Not specified	Not specified	Not specified
50 – 300	3.05 m (10'0")	1.07 m (3'6")	Avoid contact	Avoid contact
301 – 750	3.05 m (10'0")	1.07 m (3'6")	304 mm (1'0")	25 mm (0'1")
751 – 15 kV	3.05 m (10'0")	1.53 m (5'0")	660 mm (2'2")	178 mm (0'7")
15.1 – 36 kV	3.05 m (10'0")	1.83 m (6'0")	787 mm (2'7")	254 mm (0'10")
36.1 – 46 kV	3.05 m (10'0")	2.44 m (8'0")	838 mm (2'9")	432 mm (1'5")
46.1 – 72.5 kV	3.05 m (10'0")	2.44 m (8'0")	1.0 m (3'3")	660 mm (2'2")
72.6 – 121 kV	3.25 m (10'8")	2.44 m (8'0")	1.29 m (3'4")	838 mm (2'9")
138 – 145 kV	3.36 m (11'0")	3.05 m (10'0")	1.15 m (3'10")	1.02 m (3'4")
161 – 169 kV	3.56 m (11'8")	3.56 m (11'8")	1.29 m (4'3")	1.14 m (3'9")
230 – 242 kV	3.97 m (13'0")	3.97 m (13'0")	1.71 m (5'8")	1.57 m (5'2")
345 – 362 kV	4.68 m (15'4")	4.68 m (15'4")	2.77 m (9'2")	2.79 m (8'8")
500 - 550 kV	5.8 m (19'0")	5.8 m (19'0")	3.61 m (11'10")	3.54 m (11'4")
765 – 800 kV	7.24 m (23'9")	7.24 m (23'9")	4.84 m (15'11")	4.7 m (15'5")

Table E-2. Approach boundaries to exposed energized electrical conductor or circuit part for shock protection, AC 60 Hz.

Notes:

The symbol ' is used for feet and " is used for inches. Thus, 3'6" means 3 feet, 6 inches.

All dimensions are distance from exposed energized electrical conductor or circuit part to worker.

Voltage, Phase-to-Phase refers to three-phase power systems. This value also can be used for phase-to-ground or conductor-to-ground voltage.

Exposed Movable Conductor means that the bare conductor can move (e.g., an overhead transmission line conductor).

Exposed Fixed Circuit Part means the bare conductor or other circuit part is stationary and cannot move. This is the most common Limited Approach Boundary value used.

The odd voltage ranges (e.g., 46 – 72 kV) were selected in NFPA 70E because of the typical voltages of utility transmission systems.

The odd distances in meters result from conversion of English system units to metric.

Shock Boundary Analysis for DC

Shock Boundary values for DC are not found in NFPA 70E, but can be inferred because the principles of air breakdown distance are similar. Differences in the physics of air gap breakdown from 60 Hz AC to DC are small compared to the conservative values chosen for the boundaries. To determine a similar value for DC, the AC phase to phase voltage was converted to the peak of a phase to ground. This would give a value that is 0.82 x the root mean square (rms) value of the phase-to-phase voltage. Table E-3 provides approach boundaries to exposed energized electrical conductor or circuit part for DC, which is applicable to DC circuits, batteries, and capacitors. The notes help to explain the content and use of the table.

Nominal Voltage Conductor to Ground	Limited Approach Boundary Exposed Fixed Circuit Part	Restricted Approach Boundary, Includes Inadvertent Movement Adder	Prohibited Approach Boundary
≤ 100	Not specified	Not specified	Not specified
100 – 300	1.07 m (3'6")	Avoid contact	Avoid contact
300 – 1000 V	1.07 m (3'6")	304 mm (1'0")	25 mm (0'1")
1 – 5 kV	1.53 m (5'0")	450 mm (1'7")	100 mm (0'4")
5 – 15 kV	1.53 m (5'0")	660 mm (2'2")	178 mm (0'7")
15 kV – 45 kV	2.5 m (8'0")	0.84 m (2'9")	0.44 m (1'5")
45 kV – 75 kV	2.5 m (8'0")	1 m (3'2")	0.66 m (2'2")
75 kV – 150 kV	3 m (10'0")	1.2 m (4'0")	1 m (3'2")
150 kV – 250 kV	4 m (11'8")	1.7 m (5'8")	1.6 m (5'2")
250 kV – 500 kV	6 m (20'0")	3.6 m (11'10")	3.5 m (11'4")
500 kV – 800 kV	8 m (26'0")	5 m (16'5")	5 m (16'5")

Table E-3. Approach boundaries to exposed energized electrical conductor or circuit part for shock protection, DC.

Notes:

The symbol ' is used for feet and " for inches. Thus, 3'6" means 3 feet, 6 inches.

All dimensions are distance from exposed energized electrical conductor or circuit part to worker.

Voltage is conductor-to-ground.

The voltage ranges were simplified from NFPA 70E. Conservative values (e.g., the higher values) were chosen.

The distances were rounded up to generate simpler numbers.

Work near exposed conductors over 100 kV, DC is unlikely.

Arc Flash Proximity Factor	Outside Arc Flash Boundary	0
	Inside Arc Flash Boundary	10

The Arc Flash Proximity Factor is determined by performing a Flash Hazard Analysis using one of the methods as described in NFPA 70E 130.3(A). The method used cannot differ from the method that the institution is using to determine the PPE to protect against arc flash. The approximate distance of the worker to the energy source is used again to determine the arc flash hazard. If the proper PPE is used while performing work, this factor can be reduced to zero (refer to the PPE Mitigation section). Note that there cannot be both an Arc Flash Proximity Factor and a Thermal Proximity Factor.

Table E-4 for arc flash hazards, is based on IEEE 1584, *Guide for Performing Arc Flash Hazard Calculations*, which describes when an arc flash hazard is present.

Source	Includes	Thresholds
AC	60 Hz	< 240 V and the transformer supplying the circuit is rated \geq 125 kVA, or < 240 V and the circuit is supplied by more than one transformer, or \geq 240 V
DC	all	> 100 V and > 500 A
Capacitors	all	> 100 V and > 10 kJ
Batteries	all	> 100 V and > 500 A
Sub RF	1 – 3 kHz	> 250 V and > 500 A
RF	NA	Not Applicable (NA)

Table E-4. Thresholds for arc flash hazards.

Thermal Proximity Factor

	Power	
	1-30 kW	>30 kW
No contact	0	0
Contact	3	10

The Thermal Proximity Factor is determined by performing a Thermal Hazard Analysis by analyzing whether a conductive media came into contact with an energized source. The hazard to the worker in this case is a thermal one, (e.g., burn received from holding a wrench that came into contact with a high current energy source). The severity is determined by human contact with the conductive media and the power available to the contacting media. If the proper PPE is used while performing work, this factor can be reduced to zero (refer to the PPE Mitigation section). Note that there cannot be both an Arc Flash Proximity Factor and a Thermal Proximity Factor when performing the evaluation.

Source	Includes	Thresholds
DC	all	< 100 V and > 1000 W
Capacitors	all	< 100 V and > 100 J
Batteries	all	< 100 V and > 1000 W
Sub-RF	1 – 3 kHz	< 50 V and > 1000 W
RF	NA	NA

Table E-5. Thresholds for thermal burn hazards.

PPE/Equipment Mitigation

Correct for Environment hazard	reduces the Environment Factor to 0
Correct for Shock hazard	reduces the Shock Proximity Factor to 0
Correct for Arc Flash hazard	reduces the Arc Flash Proximity to 0
Correct for Thermal hazard	reduces the Thermal Proximity Factor to 0

Reduces the appropriate factor(s) to zero when the proper equipment and/or appropriately-rated PPE is used. Appropriately-rated PPE means that it is designed and manufactured to protect the worker from the electrical hazard associated with that factor and has been tested and certified (if applicable) to do so. The type and ratings (if applicable) of PPE are determined. Proper equipment means that the equipment being used has been designed and manufactured to protect the worker from the electrical hazard associated with that factor.

Injury Factor	None	1
	Shock (no fibrillation) or burn (1 st degree)	3
	Arc Flash/Blast or burn (2 nd degree) ¹	5
	Shock resulting in effects on heart ²	10
	Permanent disability or burn (3 rd degree) ¹	20
	Fatality	100

The Injury Factor is determined by the injury to the worker(s) involved in the event.

¹Assign the value if the burn injury is affecting more than 5% of the body surface.

²Effects on the heart are determined by an Electrocardiogram.

Electrical Severity Significance

The ES equation generates scores from 0 to 310,000. This range provides an exponentially rising severity that, when based on a logarithmic scale, breaks down into three categories of significance (as shown in Table E-6): High, Medium and Low.

Significance	Electrical Severity (ES)
High	≥ 1750
Medium	31 – 1749
Low	1 - 30

Table E-6. Electrical severity significance categories.

Low (score 1-30) events can be those items that truly did not pose a risk to the worker such as carpet shock and mishaps that were expected to happen in the work control document and for which the worker was appropriately prepared.

The the low (score 1-30) events are low enough in severity that they should be addressed on site by the contractor.

Electrical Severity Index (ESI)

The Electrical Severity Index (ESI) performance metric was developed to normalize the events against organizational work hours.

The ESI should be calculated monthly.

The rolling 12-month ESI average should also be calculated monthly to limit small period fluctuations.

Both the monthly ESI and the rolling 12-month ESI average should be tracked graphically.

The ESI is calculated when each event is weighted for severity and then averaged with other events to obtain a result representing performance.

The ES is used as the weighting factor for each event in the ESI metric below.

$$ESI = \frac{200,000 [(ES_{event1}) + (ES_{event2}) + (ES_{eventN}) \dots]}{(hours\ worked)}$$

where:

ESI = Electrical Severity Index

200,000 = constant (man hours for a 100 person work force)

Event = electrical safety event

ES = the Electrical Severity calculated above for a specific event.

Hours worked = actual work hours for work population

Note: same as hours used to calculate OSHA Recordable Case Rate

The ESI is intended to use a similar approach to calculating Recordable Case Rate (source of work hours is same). It assigns a numerical weighting factor to each event, the more risk or consequence associated with the event, the higher the weighting factor.

An evaluation should be performed to determine if the goal for continuous improvement is being met. An occurrence that results in electrical injury would be considered unsatisfactory performance.

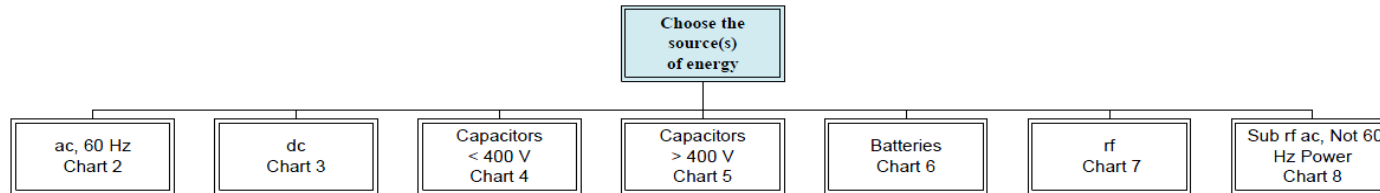

Chart 1. Overview of Electrical Hazards.

The following charts, taken collectively, represent most of the electrical hazards found in electrical equipment. Consequently, all of the charts should be considered when identifying the hazards associated with any piece of electrical equipment. A single piece of equipment may have multiple energy sources, and the worker may have been exposed to a combination of hazards. To aid hazard identification, each chart has cross-reference notes. For example, the DC chart (Chart 3) has cross-reference notes to capacitance, battery, and 60 Hz hazard tables. Event evaluators should have a thorough understanding of the equipment involved in the electrical event. Consulting manuals and schematics and speaking with factory service representatives and SMEs are ways to ensure that all of the hazards are fully understood and that all of the pertinent classes are taken into account. Some guidelines on use of the hazard classification charts are given. They are general, and there may be exceptions to each one:

- If these guidelines and the equipment are not understood, an electrical SME should be consulted.
- All equipment gets its power from the facility (Chart 2) or batteries (Chart 6), thus, equipment starts with one of those classes.
- Most small appliances, hand tools, and portable laboratory equipment plugs into facility receptacles: in general, if it can be carried, most likely it uses 120 to 240 V.
- Larger facility and laboratory equipment may use up to 480 V.
- All electronic equipment and much other R&D equipment convert 60 Hz power into DC. All DC power supplies have some capacitance. Thus, DC power supplies have both DC hazards (Chart 3) and capacitor hazards (Charts 4/5). Both are evaluated.
- All uninterruptible power supplies (UPS) have battery hazards (Chart 6), as well as 60 Hz power hazards (Chart 2), since they usually are tied into 60 Hz power (input), and produce 60 Hz type power (output).

DOE-HDBK-1092-2013

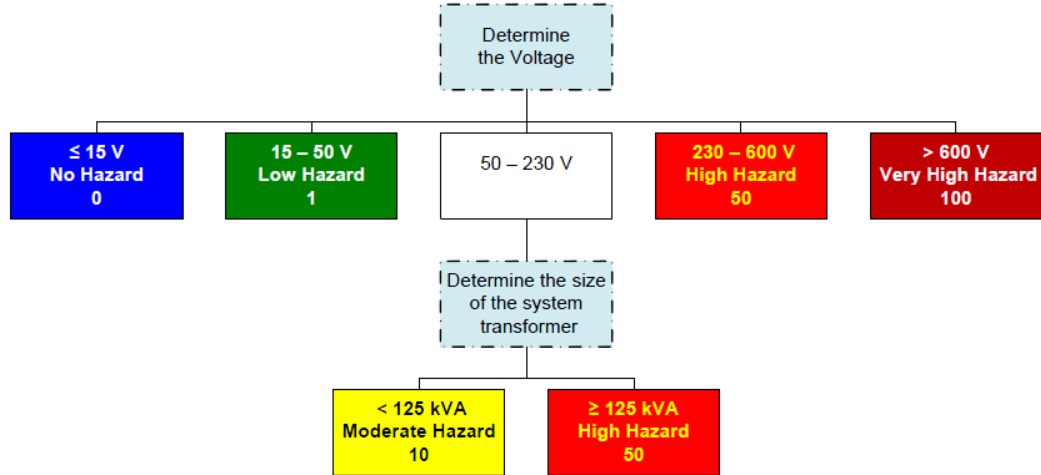

Chart 2. AC, 60 Hz.

Notes on use:

1. The voltage is the rms voltage for 60 Hz power.
2. For current limited 60 Hz circuits (≤ 5 mA), use Chart 8.
3. Evaluate all energy sources the worker was exposed to:
 - For DC, use Chart 3
 - For capacitors, less than 400 V, use Chart 4
 - For capacitors, greater than 400 V, use Chart 5
 - For batteries, use Chart 6
 - For RF, use Chart 7
 - For Sub-RF and AC, use Chart 8

DOE-HDBK-1092-2013

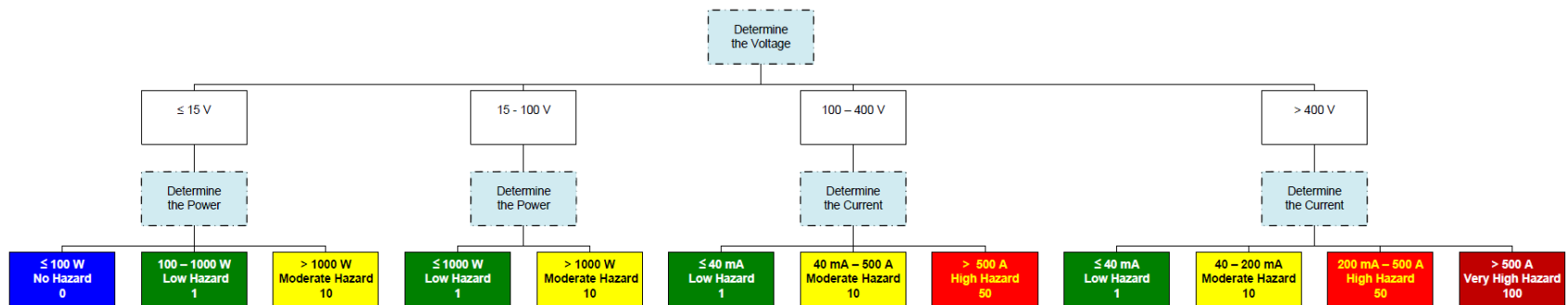

Chart 3. DC.

Notes on use:

1. The voltage is the DC voltage.
2. The power is available short-circuit power.
3. The current is available short-circuit current.
4. Evaluate all energy sources the worker was exposed to:
 - For AC 60 Hz, use Chart 2
 - For capacitors, less than 400 V, use Chart 4
 - For capacitors, greater than 400 V, use Chart 5
 - For batteries, use Chart 6
 - For RF, use Chart 7
 - For Sub-RF AC, use Chart 8

DOE-HDBK-1092-2013

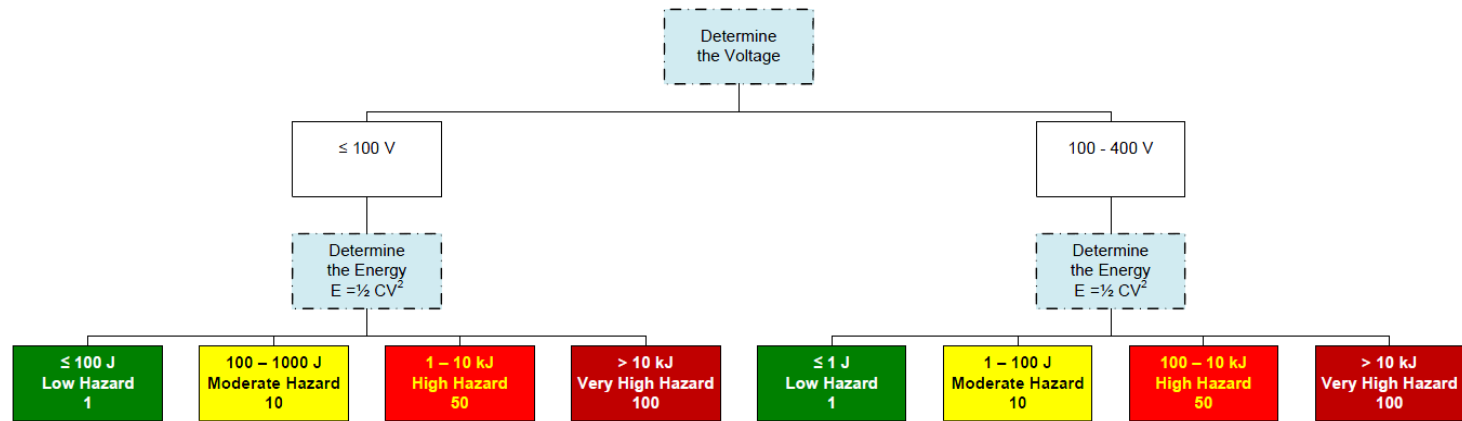

Chart 4. Capacitors, < 400 V.

Notes on use:

1. The voltage is AC (rms) or DC maximum charge voltage on the capacitor.
2. The energy is maximum energy stored in the capacitor as determined by $E = \frac{1}{2} CV^2$.
3. Evaluate all energy sources the worker was exposed to:
 - For AC 60 Hz, use Chart 2
 - For DC, use Chart 3
 - For capacitors, greater than 400 V, use Chart 5
 - For batteries, use Chart 6
 - For RF, use Chart 7
 - For Sub-RF AC, use Chart 8

DOE-HDBK-1092-2013

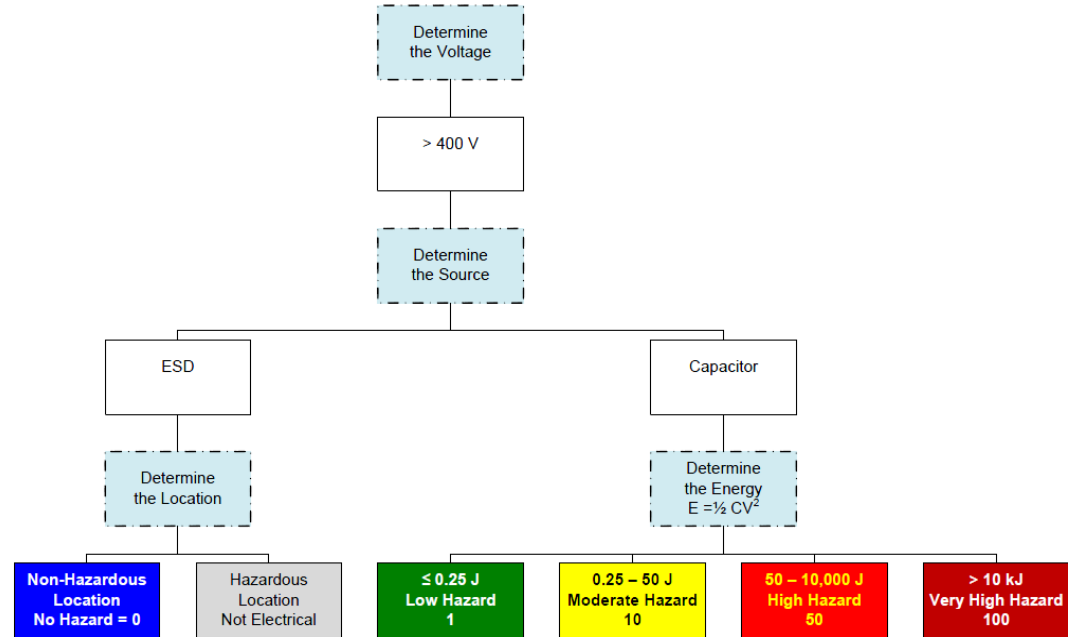

Chart 5. Capacitors, > 400 V.

Notes on use:

1. The voltage is AC (rms) or DC maximum charge voltage on the capacitor.
2. The energy is maximum energy stored in the capacitor as determined by $E = \frac{1}{2} CV^2$.
3. Electrostatic Discharge in a hazardous location could potentially have a significant hazard. This tool cannot evaluate this hazard.
4. Evaluate all energy sources that the worker was exposed to:
 - For AC 60 Hz, use Chart 2
 - For DC, use Chart 3
 - For capacitors, less than 400 V, use Chart 4
 - For batteries, use Chart 6
 - For RF, use Chart 7
 - For Sub-RF AC, use Chart 8

DOE-HDBK-1092-2013

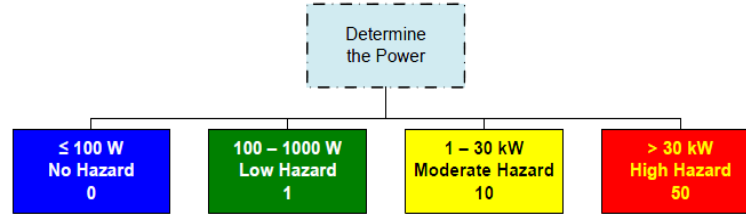

Chart 6. Batteries.

Notes on use:

1. The power is available short-circuit power.
2. Note that if the battery voltage is greater than 100 V also refer to Chart 3 to classify the shock hazard.
3. Evaluate all energy sources that the worker was exposed to:
 - For AC 60 Hz, use Chart 2
 - For DC, use Chart 3
 - For capacitors, less than 400 V, use Chart 4
 - For capacitors, greater than 400 V, use Chart 5
 - For RF, use Chart 7
 - For Sub-RF AC, use Chart 8

DOE-HDBK-1092-2013

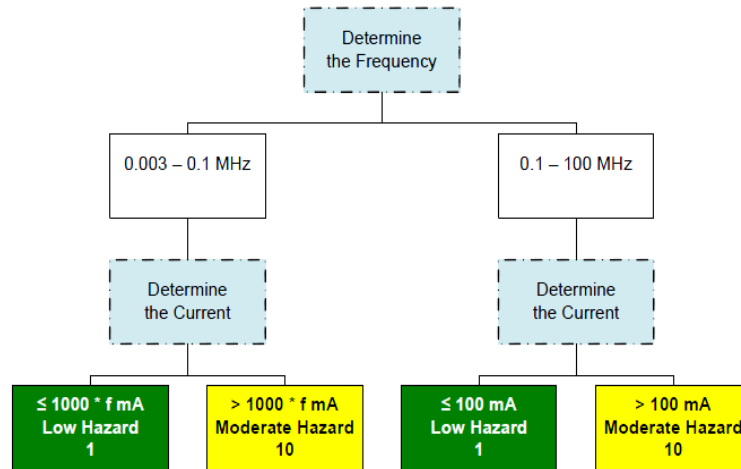

Chart 7. RF circuits, 3 kHz to 100 MHz.

Notes on use:

1. f in the chart is frequency in MHz
2. This chart only addresses the RF shock hazard; it does NOT address exposure to electromagnetic fields.
3. The allowable shock currents are much higher than 60 Hz (e.g., 100 milliamperes (mA) is allowed for 100 kHz).
4. Evaluate all energy sources the worker was exposed to:
 - For AC 60 Hz, use Chart 2
 - For DC, use Chart 3
 - For capacitors, less than 400 V, use Chart 4
 - For capacitors, greater than 400 V, use Chart 5
 - For batteries, use Chart 6
 - For Sub-RF AC, use Chart 8

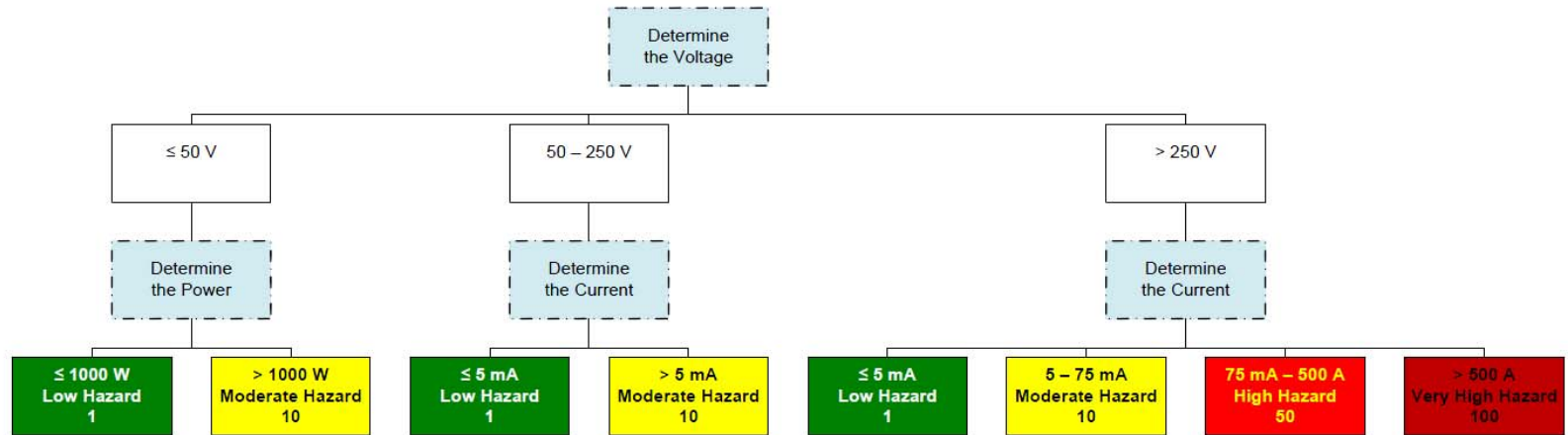

Chart 8. Sub-RF AC, 1 Hz to 3 kHz, NOT 60 Hz Power.

Notes on use:

1. This chart is NOT to be used for 60 Hz power.
2. The voltage is rms voltage.
3. The power is available short circuit power.
4. The current is available short circuit current.
5. Evaluate all energy sources the worker was exposed to:
 - For AC 60 Hz, use Chart 2
 - For DC, use Chart 3
 - For capacitors, less than 400 V, use Chart 4
 - For capacitors, greater than 400 V, use Chart 5
 - For batteries, use Chart 6
 - For RF, use Chart 7