

# Headlamp Glare and Range – Enrichment of Data by Calculations

Gert Langhammer  
Chairman CIE TC4-45

Geneva, 01 April 2014

---

## Headlamp Glare and Range – Enrichment of data by calculation

---

### Agenda

- The role of passing beam cutoff
- CIE TC4-45 - objective method of assessing headlamp glare and range
  - History of CIE TC4-45
  - Headlamp glare and range in TC4-45
- Headlamp glare and range under different conditions – collection of data as result of TC4-45 calculations
- Calculation results in relation to Klettwitz field test outcome

## The passing beam cutoff

---

**The role of the passing beam** is to **provide good illumination** of the road scene **without causing unacceptable glare to oncoming drivers**. This is achieved by a combination of the control of the performance of the passing beam by means of the provisions in the applicable headlamp regulation and the correct installation according to Regulation 48.

The requirements in the installation regulation would ideally be performance based but as these are fundamentally photometric requirements it is not possible to carry out objective performance testing on a complete vehicle. This means that the **control of the headlamp performance must be achieved through the application of the requirements in the headlamp regulations** and the **“on-road” performance must be assured by correct installation** according to the provisions relating to the initial aim and the maintenance of aim in Regulation 48.

# CIE TC4-45

Performance Assessment Method  
for Vehicle Headlamps

## The passing beam cutoff

The Passing Beam Cutoff is the visible line perceived by the eye when the beam pattern is projected onto a vertical screen.

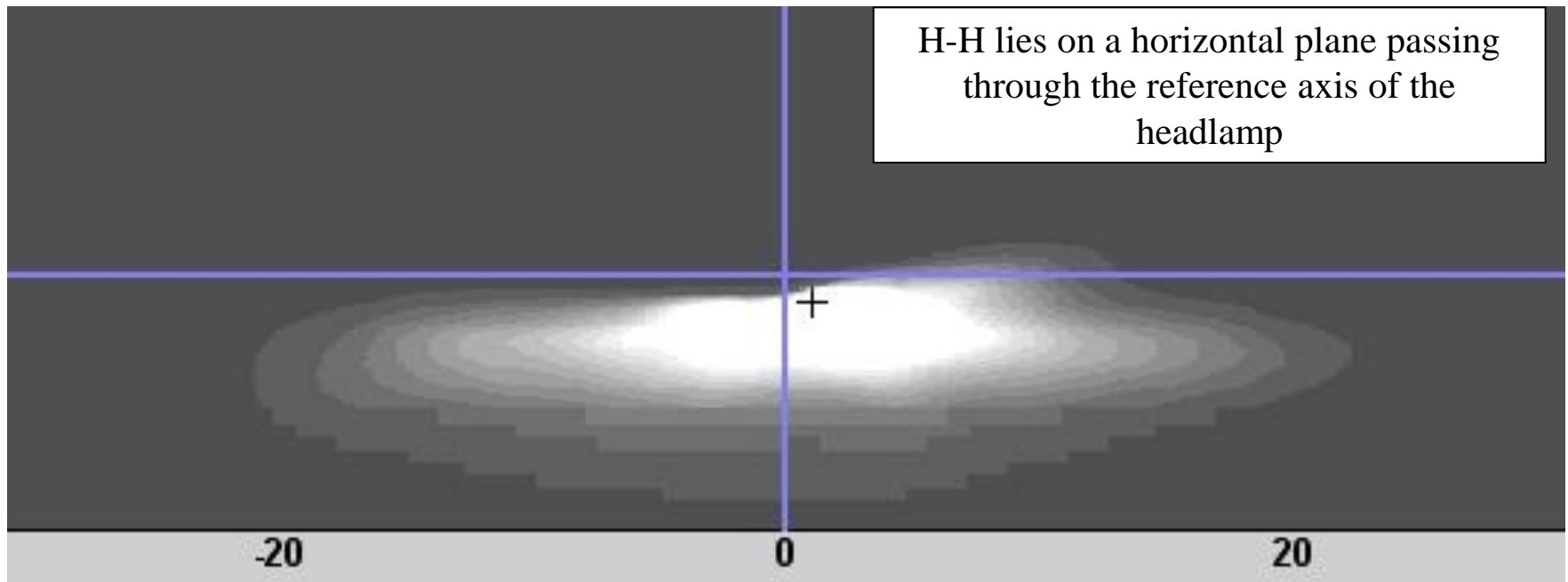

Normally the beam pattern is viewed at a distance of 25m for visual aiming prior to photometry but a viewing distance of 10m is also allowed for practical reasons

## The passing beam cutoff

---

The clarity of the cutoff line varies from diffuse to sharp. Sharpness is defined in the headlamp regulations to ensure that the beam can be visually aimed by means of the cutoff but equally the cutoff is not too sharp as this contributes to glare complaints and driver fatigue.

*E/ECE/324/Rev.2/Add.111/Rev.2  
E/ECE/TRANS/505/Rev.2/Add.111/Rev.2  
Annex 9*

### 2.2. Sharpness of “cut-off”

The sharpness factor  $G$  is determined by scanning vertically through the horizontal part of the “cut-off” at  $2.5^\circ$  from the V-V where:

$G = (\log E_\beta - \log E_{(\beta + 0.1^\circ)})$  where  $\beta$  = the vertical position in degrees.

The value of  $G$  shall not be less than 0.13 (minimum sharpness) and not greater than 0.40 (maximum sharpness).

There is no significant relationship between the cutoff sharpness and the performance of the headlamp on the road. A headlamp that just meets the minimum requirements of the regulation may have a sharper cutoff than a headlamp that exceeds the minimum requirements by a factor of several times.

# CIE TC4-45

## Performance Assessment Method for Vehicle Headlamps

### Two passing beam patterns compared – the passing beam cutoff

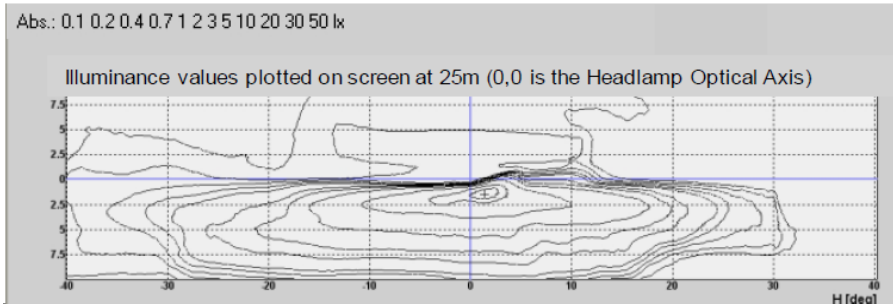

Halogen Headlamp with horizontal cutoff aimed 1%  
down



Range based upon assumption that  
the horizontal (left side) cutoff line  
will intersect the road surface at  $D =$   
 $H/1\%$   
( $D =$  Range;  $H =$  mounting height)

Mounting Height = 0.63m  
Assumed Range = 63m

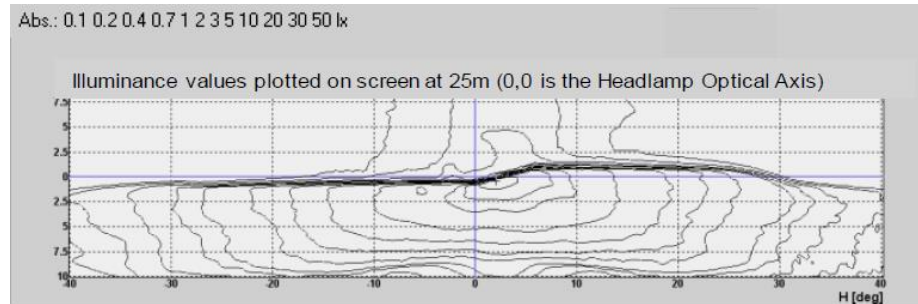

HID Headlamp with horizontal cutoff aimed 1% down



Range based upon assumption that  
the horizontal (left side) cutoff line  
will intersect the road surface at  $D =$   
 $H/1\%$   
( $D =$  Range;  $H =$  mounting height)

Mounting Height = 0.72m  
Assumed Range = 72m

# CIE TC4-45

## Performance Assessment Method for Vehicle Headlamps

### Two passing beam patterns compared – Range according to TC4-45

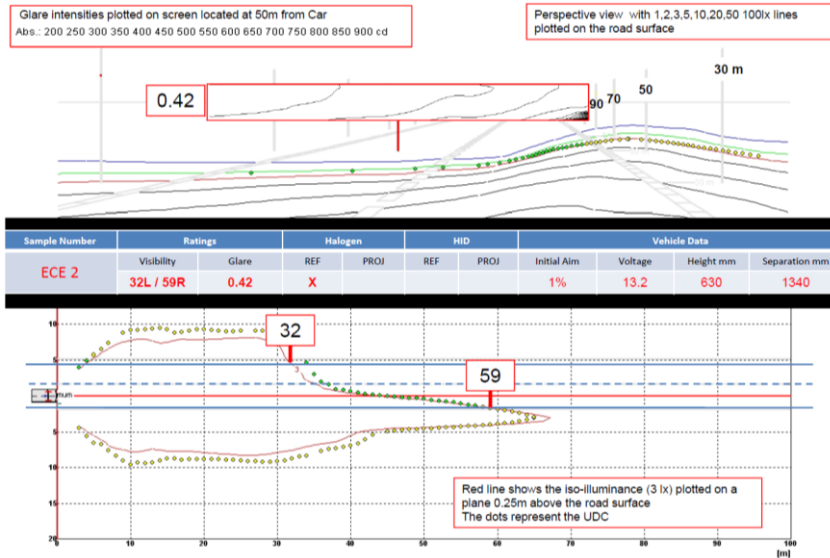

Range based upon CIE TC4-45 Criteria = 32m Left /  
59 m Right

Mounting Height = 0.63m

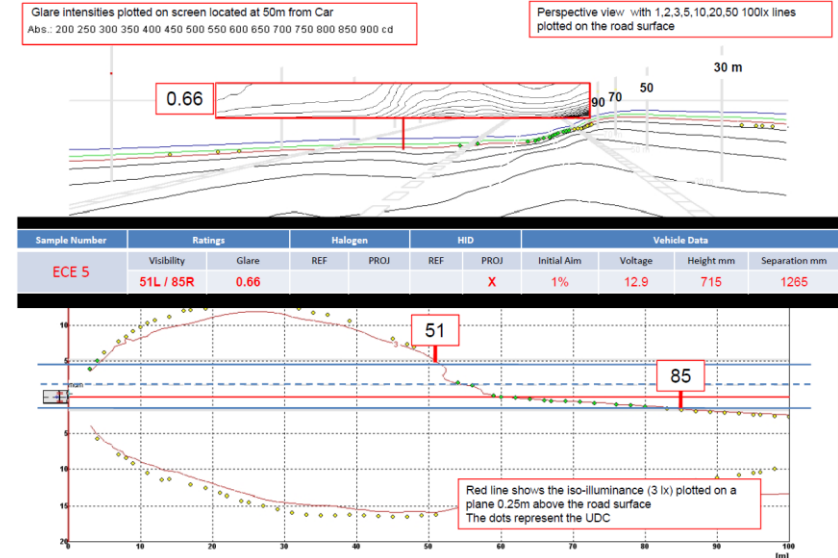

Range based upon CIE TC4-45 Criteria = 51m Left /  
85 m Right

Mounting Height = 0.72m

# CIE TC4-45

## Performance Assessment Method for Vehicle Headlamps

### Conclusion

Halogen Headlamp with horizontal cutoff aimed 1% Down



Range based upon CIE TC4-45 Criteria  
= 32m Left / 59 m Right  
Mounting Height = 0.63m



Range based upon assumption that the horizontal (left side) cutoff line will intersect the road surface at  $D = H/1\%$   
(D = Range; H = mounting height)

Mounting Height = 0.63m  
Assumed Range = 63m

	Discrepancy	
	Left Side	Right Side
Actual (Calculated)	32m	59m
Assumed	63m	**

HID Headlamp with horizontal cutoff aimed 1% Down



Range based upon CIE TC4-45 Criteria  
= 51m Left / 85 m Right Mounting  
Height = 0.72m



Range based upon assumption that the horizontal (left side) cutoff line will intersect the road surface at  $D = H/1\%$   
(D = Range; H = mounting height)

Mounting Height = 0.72m  
Assumed Range = 72m

	Discrepancy	
	Left Side	Right Side
Actual (Calculated)	51m	85m
Assumed	72m	**

\*\* The assumption of the range is based upon the position of the horizontal part of the cutoff so it does not apply to the Right Side figures



# CIE TC4-45

Performance Assessment Method  
for Vehicle Headlamps

---

## TC4-45 - objective method of assessing headlamp glare and range

---

### History of CIE TC4-45

# CIE TC4-45

Performance Assessment Method  
for Vehicle Headlamps

---

## **TC4-45 - objective method of assessing headlamp glare and range**

---

In 2003 GTB and NCAP created a taskforce with the aim of developing a headlamp performance rating system to be proposed to the European New Car Assessment Programme (Euro NCAP).

After Euro NCAP decision in 2005 not to continue to introduce a headlight rating system the work of this taskforce was transferred into CIE structure.

CIE Technical Committee 4-45, working in conjunction with GTB, continued to work on the refinement of the assessment of headlamp range and glare.

# CIE TC4-45

Performance Assessment Method  
for Vehicle Headlamps

---

## **TC4-45 - objective method of assessing headlamp glare and range**

---

Experts from 52 manufacturers, institutions and test services worldwide were taking part in the development of an objective method of assessing vehicle front lighting. The aim was to create a method which is based just on photometric measurements and calculations.

In 2010 the work of TC4-45 was finalized with the publication of a CIE Technical Report (CIE188: 2010).

In 2011 CIE released the new standard:

CIE S021/E:2011  
Vehicle Headlighting Systems  
Photometric Performance – Method of Assessment

# CIE TC4-45

Performance Assessment Method  
for Vehicle Headlamps

---

**Standard CIE S021/E:2011**

**Technical Report CIE 188:2010**

---



---

**PRESS RELEASE**

May 2011

---

**New Standard CIE S 021/E:2011**

## **Vehicle Headlighting Systems Photometric Performance - Method of Assessment**

This Standard specifies a method to consistently assess the photometric performance of vehicle headlighting systems to enable the performance of different systems to be compared. The requirements are given in relation to road scene illumination and the limitation of glare, and the performance is assessed using parameters relevant to lane guidance and the detection of pedestrians and objects.

The Standard includes a measurement and calculation procedure. It does not specify the format of an assessment report.

The Standard is written in English and has been approved by CIE National Committees. It is readily available at the National Committees of the CIE or via the website of the Central Bureau of the CIE ([www.cie.co.at](http://www.cie.co.at)).

The price of this Standard is EUR 135,- (Members of the National Committees of the CIE get 66,7% discount).



ISBN 978 3 901906 84 8

COMMISSION INTERNATIONALE DE L'ECLAIRAGE  
INTERNATIONAL COMMISSION ON ILLUMINATION  
INTERNATIONALE BELEUCHTUNGSKOMMISSION

# **TECHNICAL REPORT**

## **PERFORMANCE ASSESSMENT METHOD FOR VEHICLE HEADLIGHTING SYSTEMS**

CIE 188:2010

UDC: 628.971.85  
628.971.85:629.113.06

Descriptor: Lighting by lamps attached to the vehicle  
Lighting by motor vehicle lamps

---

**GTB**

The International Automotive Lighting  
and Light Signalling Expert Group

Groupe de Travail "Bruxelles 1952"

GTB Document No. CE-5001

129

# CIE TC4-45

Performance Assessment Method  
for Vehicle Headlamps

## Headlamp Glare and Range in TC4-45 – input parameters

The system Headlamps + Car is evaluated ...

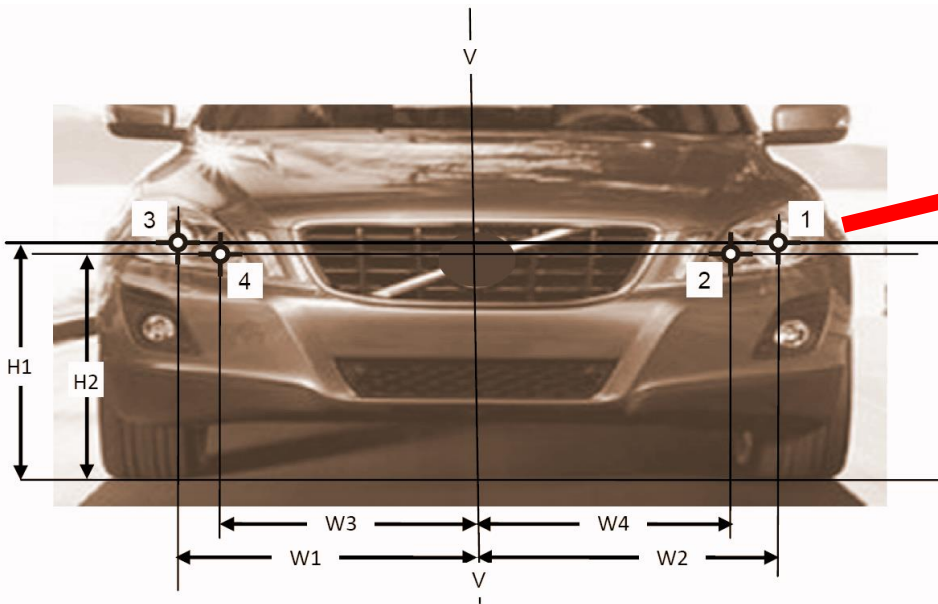

...by recording mounting positions  
and supply voltage on the car ...

...and by measuring the photometric  
values in a laboratory.

# CIE TC4-45

Performance Assessment Method  
for Vehicle Headlamps

---

## Headlamp Glare and Range in TC4-45 – Definition of Glare Zone

---



# CIE TC4-45

Performance Assessment Method  
for Vehicle Headlamps

## Headlamp Glare and Range in TC4-45 – Definition of Glare Zone

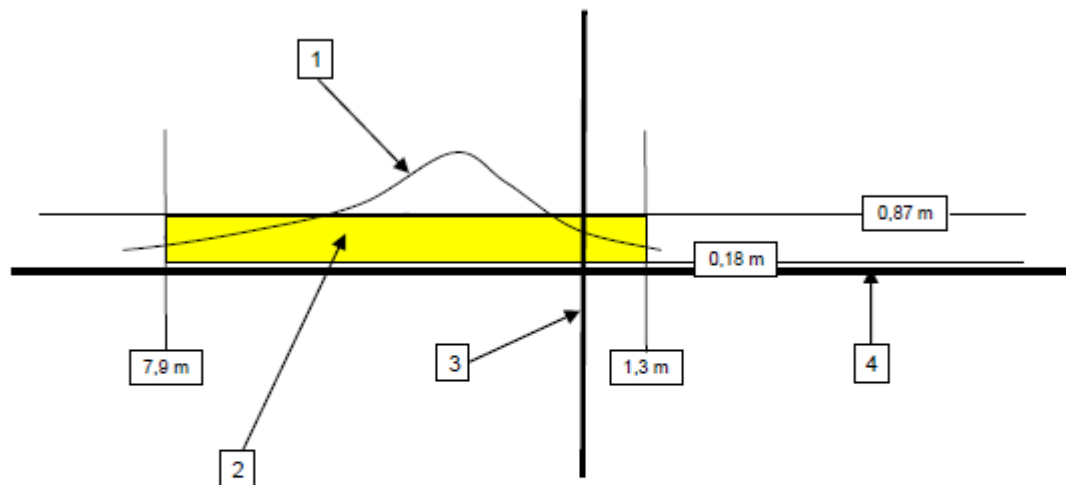

### Key

- 1 the curve indicates the probable location of the oncoming driver's eyes as a percentage of all instances on a range of road types based upon the work of Damasky [3]
- 2 for detail of this zone see Figure 16
- 3 vertical line through the longitudinal axis of vehicle
- 4 this horizontal line is located at a height of 0,75 m above the road surface

# CIE TC4-45

Performance Assessment Method  
for Vehicle Headlamps

## Headlamp Glare and Range in TC4-45 – Definition of Passing Beam Range





# CIE TC4-45

Performance Assessment Method  
for Vehicle Headlamps

## Headlamp Glare and Range in TC4-45 – Definition of Passing Beam Range

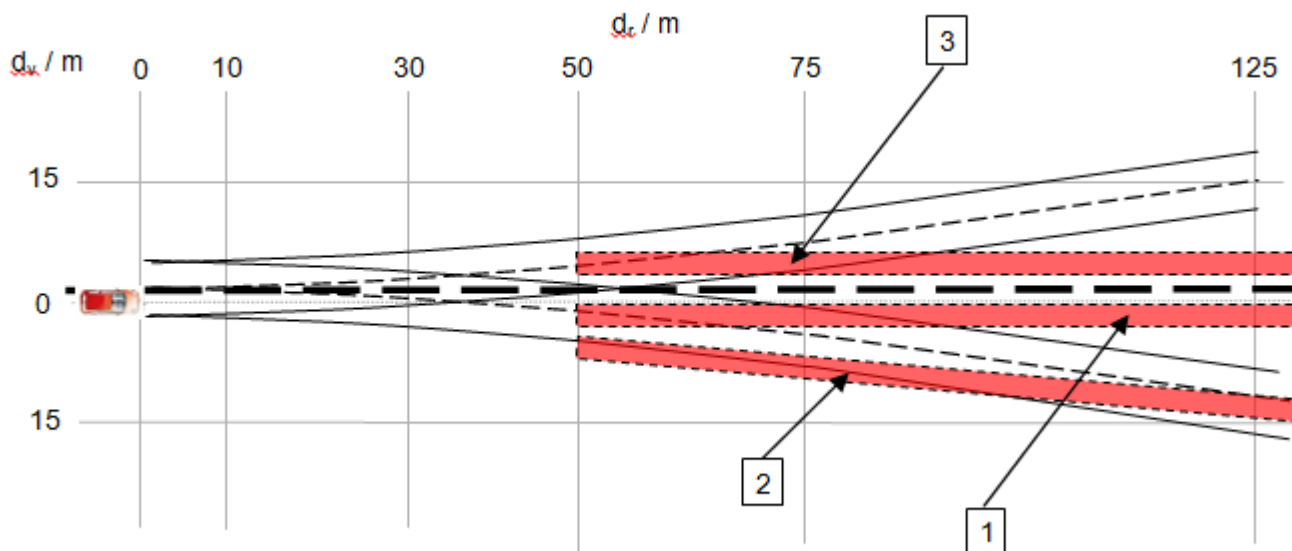

- $d_c$  distance along the road  
 $d_v$  distance from vehicle longitudinal axis
- 1 Zone A range assessment – straight road
  - 2 Zone B range assessment – curved road
  - 3 Zone C range assessment – pedestrian visibility

Road width 6m (3m per lane), 500m curve radius

# CIE TC4-45

Performance Assessment Method  
for Vehicle Headlamps

## Headlamp Glare and Range in TC4-45 – Definition of Passing Beam Range

### Zone A: Range of Passing Beam on a straight road

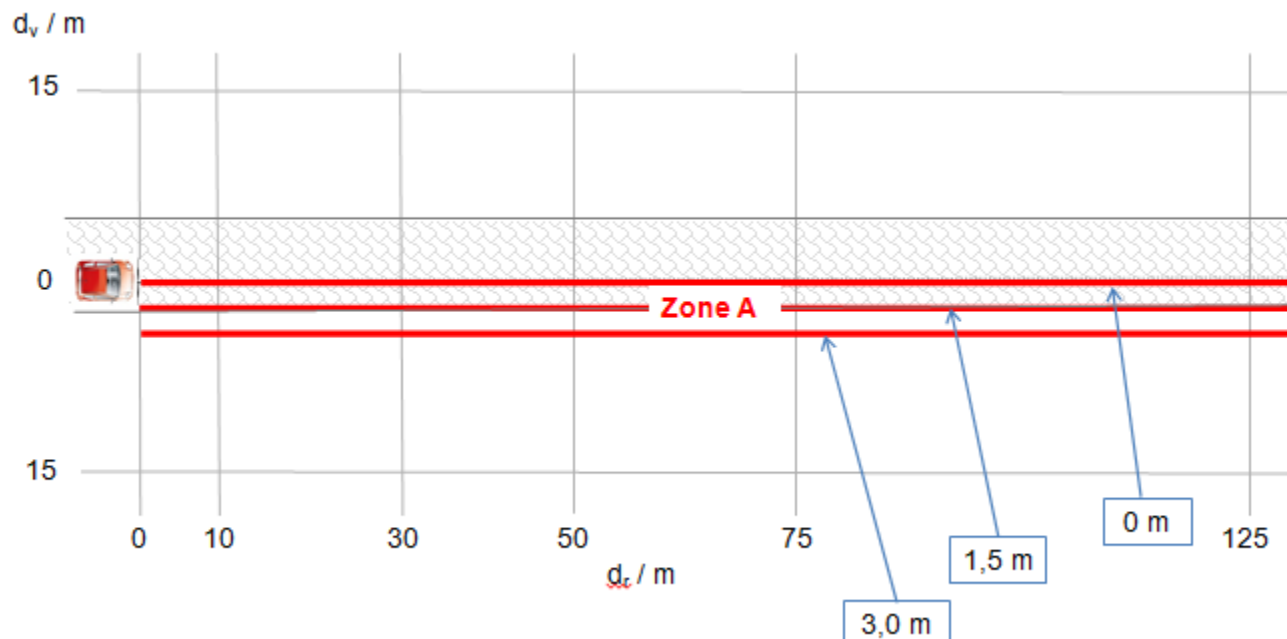

$d_c$  distance along the road  
 $d_v$  distance from vehicle longitudinal axis

NOTE The longitudinal lines in Zone A are situated at 0 m, 1,5 m and 3,0 m to the nearside of the longitudinal axis of the vehicle.

## Headlamp Glare and Range under different conditions

---

### Collection of data:

#### Glare and Range for headlamps

- with different types of light sources
- at different mounting heights

### Luminous Flux in Glare Zone - H7, D3S and LED types of passing beams

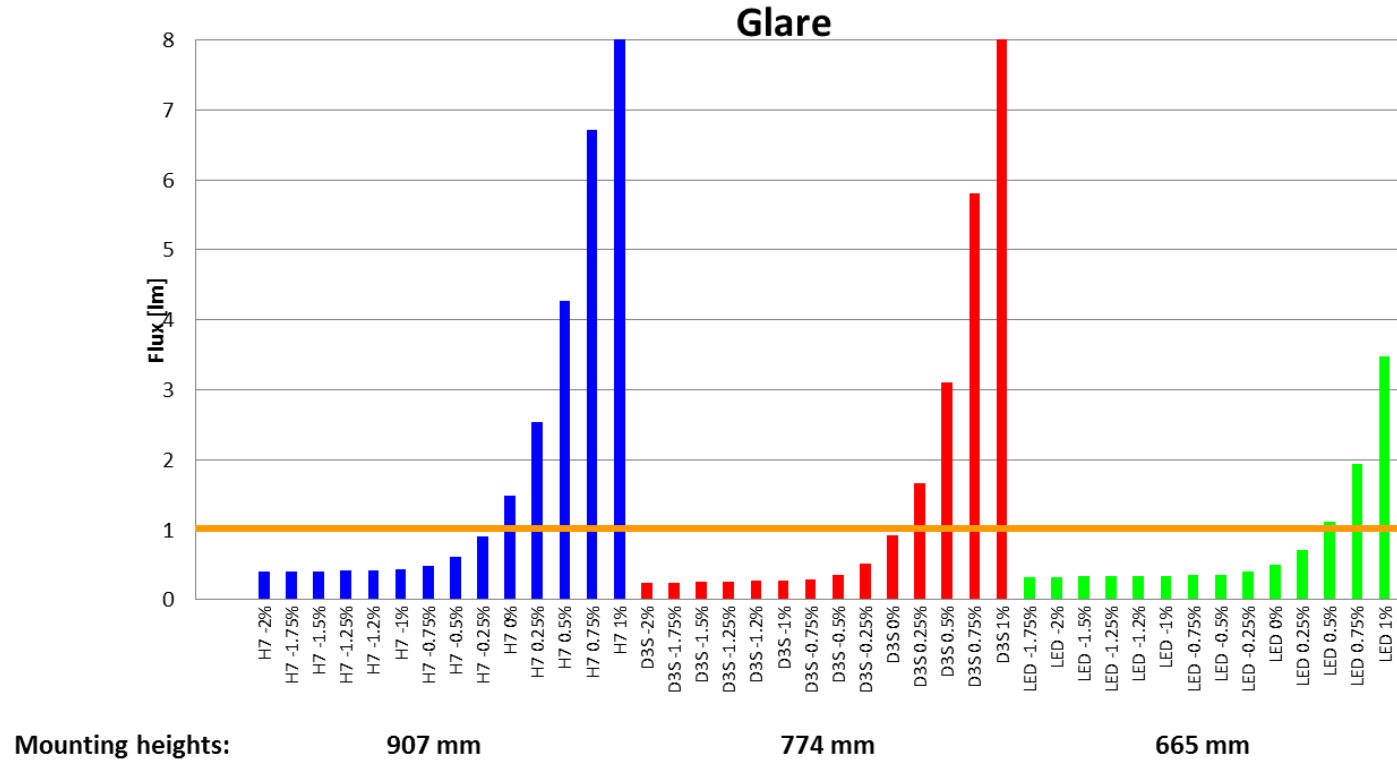

- vertical inclination of 0% means horizontal cut-off at H-H
- vertical inclination of -1,0% means horizontal cut-off 0,57° below H-H

# CIE TC4-45

Performance Assessment Method  
for Vehicle Headlamps

## Zone A - H7, D3S and LED types of passing beams

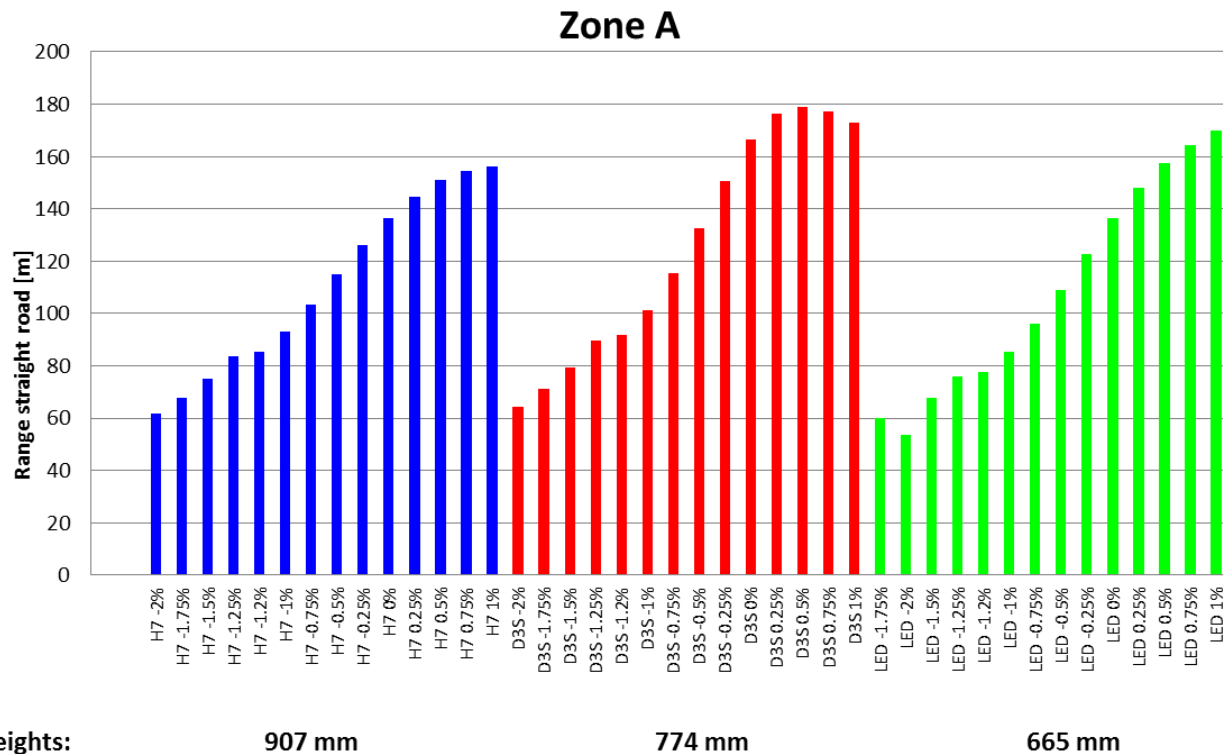

→ vertical inclination of 0% means horizontal cut-off at H-H

→ vertical inclination of -1,0% means horizontal cut-off 0,57° below H-H

# CIE TC4-45

Performance Assessment Method  
for Vehicle Headlamps

## Glare – H7 headlamp at different mounting heights

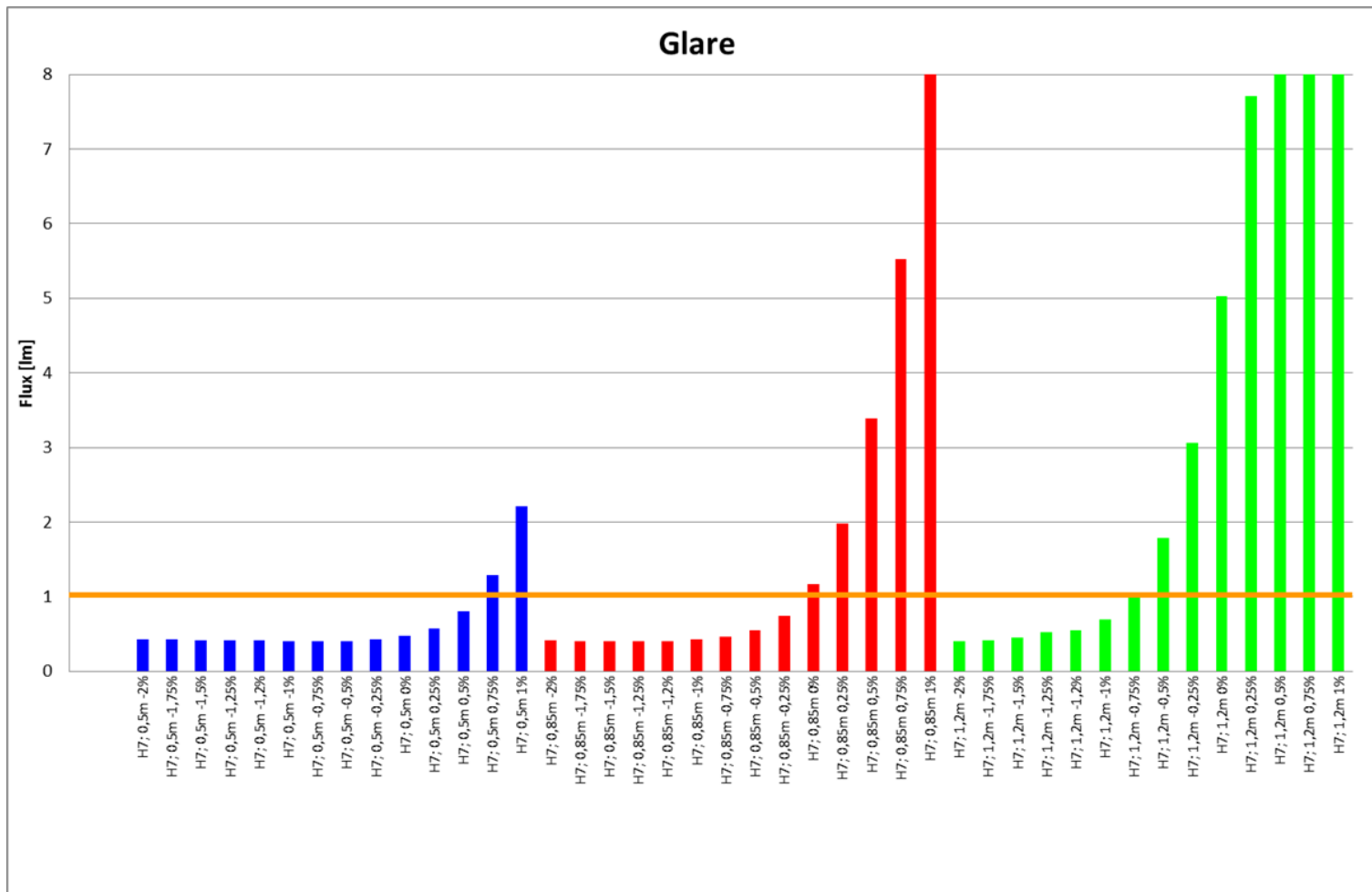

# CIE TC4-45

Performance Assessment Method  
for Vehicle Headlamps

## Glare – D3S headlamp at different mounting heights

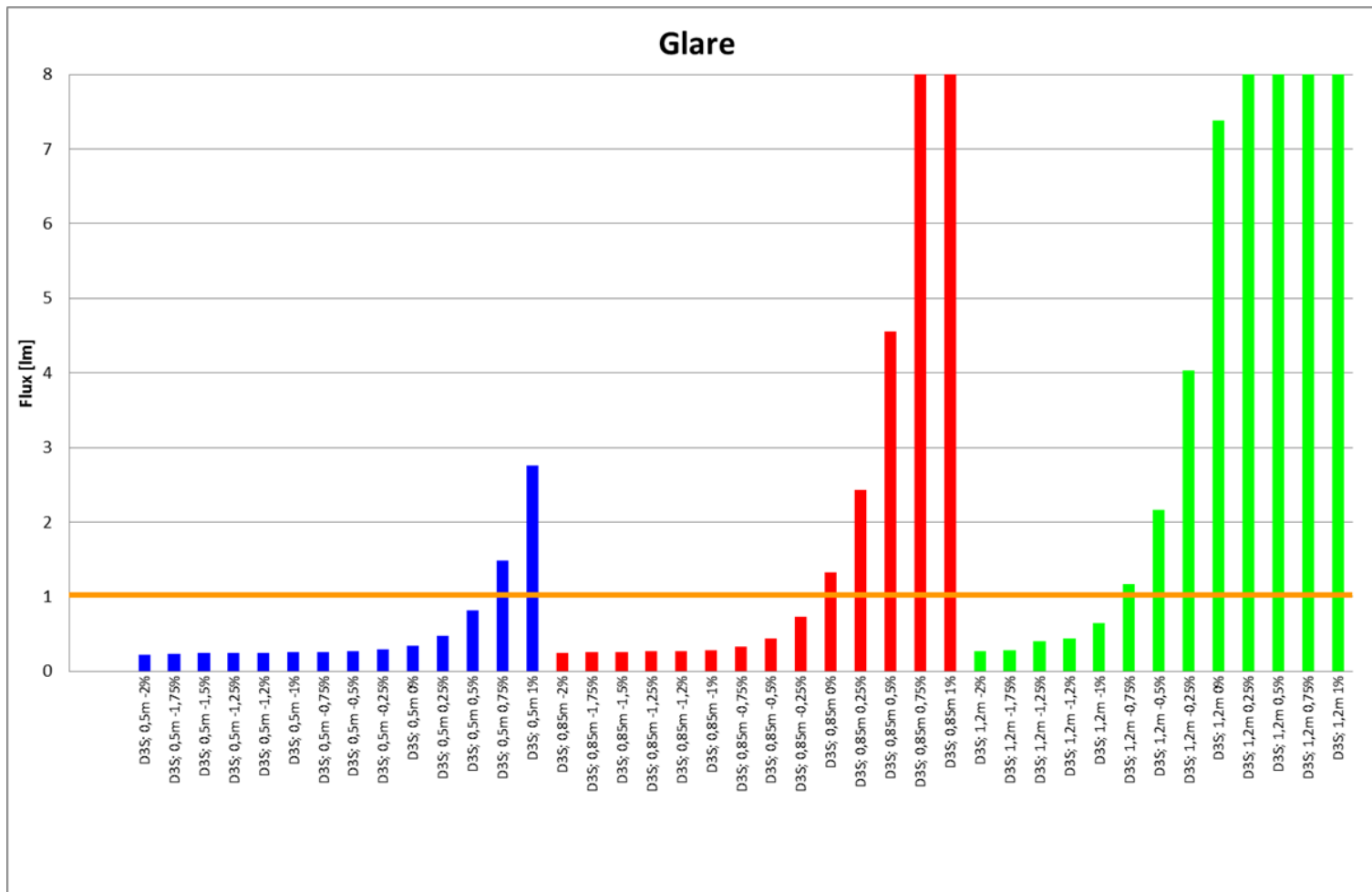

# CIE TC4-45

Performance Assessment Method  
for Vehicle Headlamps

## Glare – LED headlamp at different mounting heights

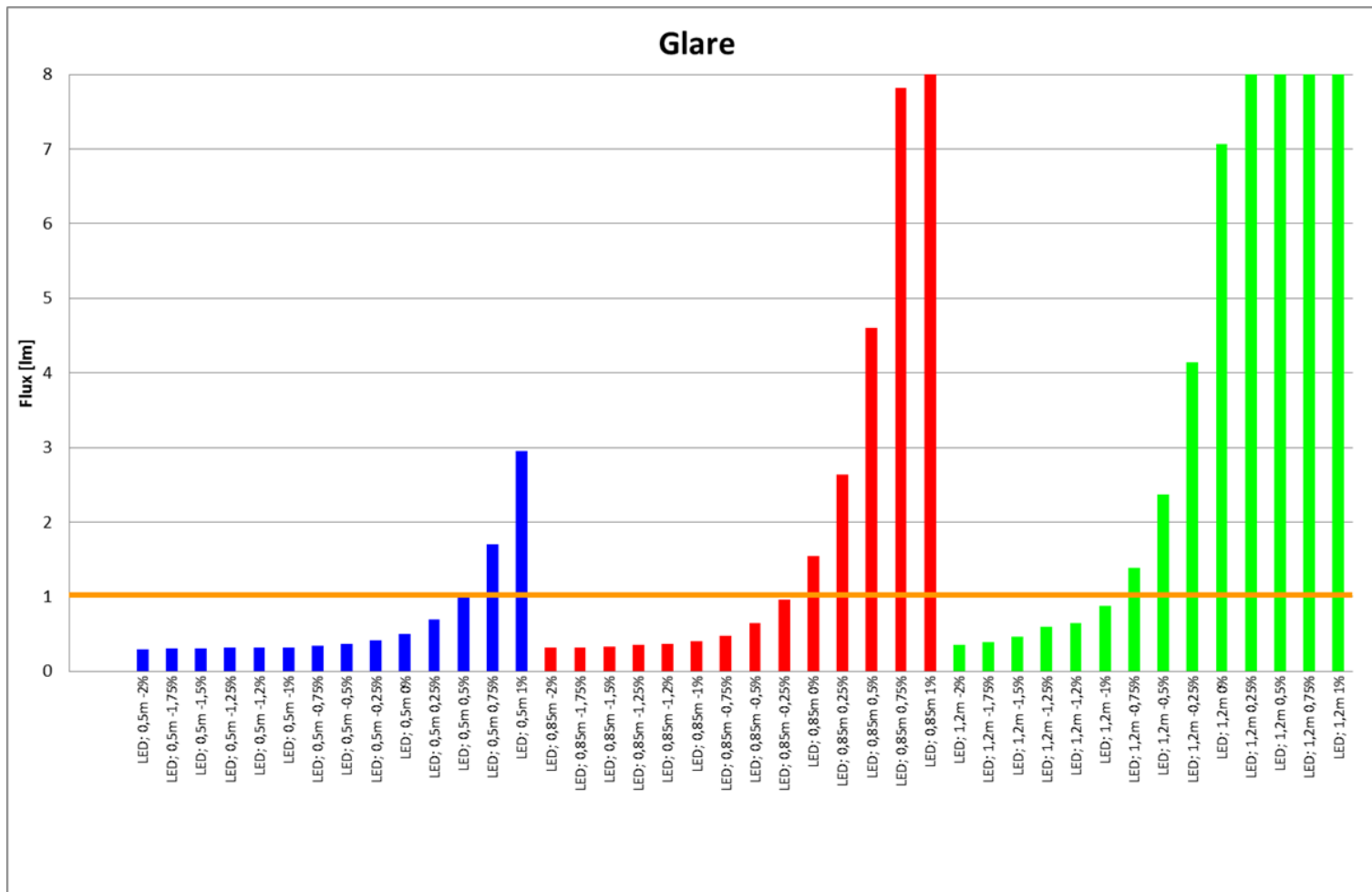



# CIE TC4-45

Performance Assessment Method  
for Vehicle Headlamps

## Range in Zone A – H7 headlamp at different mounting heights

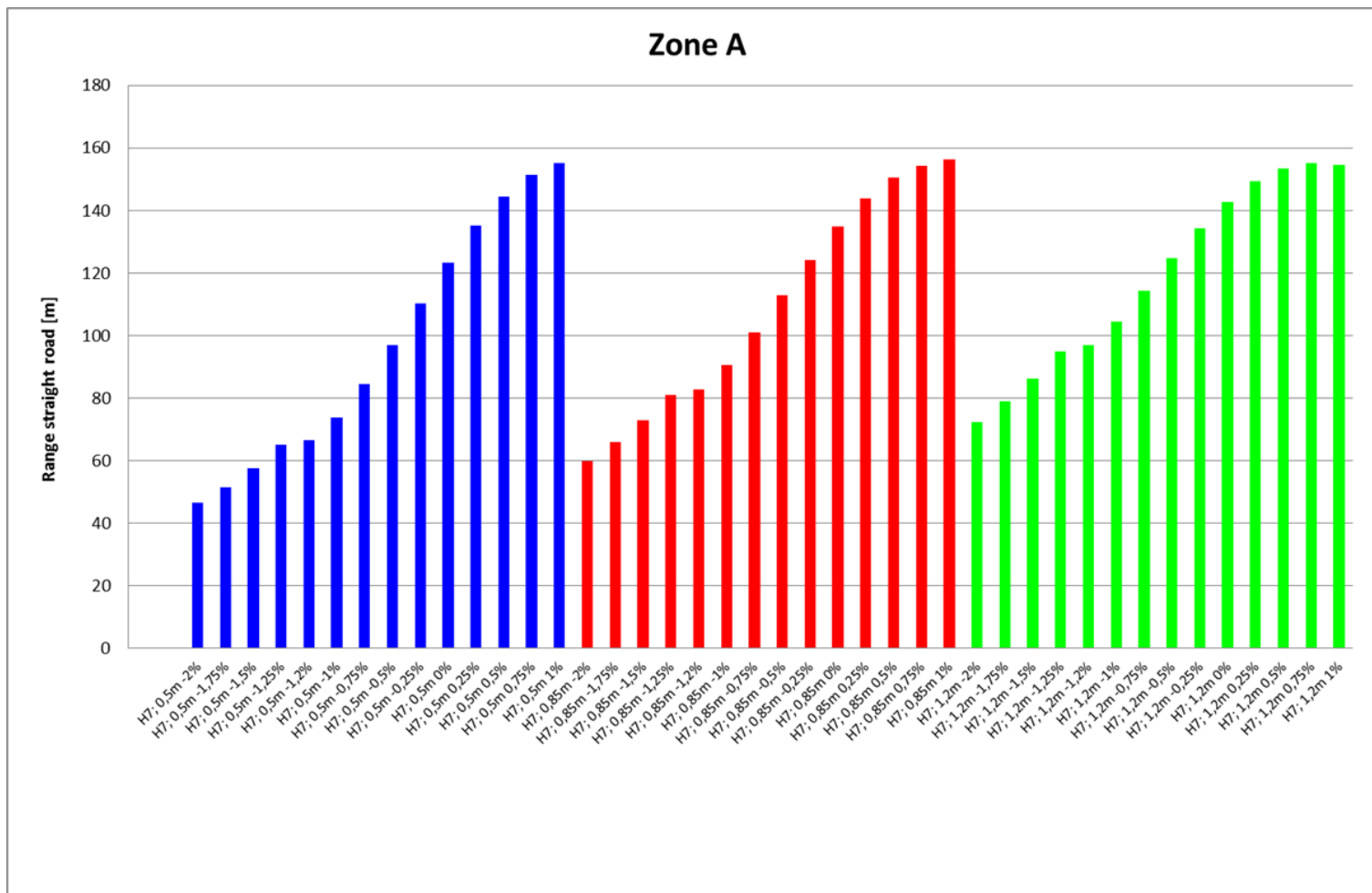

# CIE TC4-45

Performance Assessment Method  
for Vehicle Headlamps

## Range in Zone A – D3S headlamp at different mounting heights

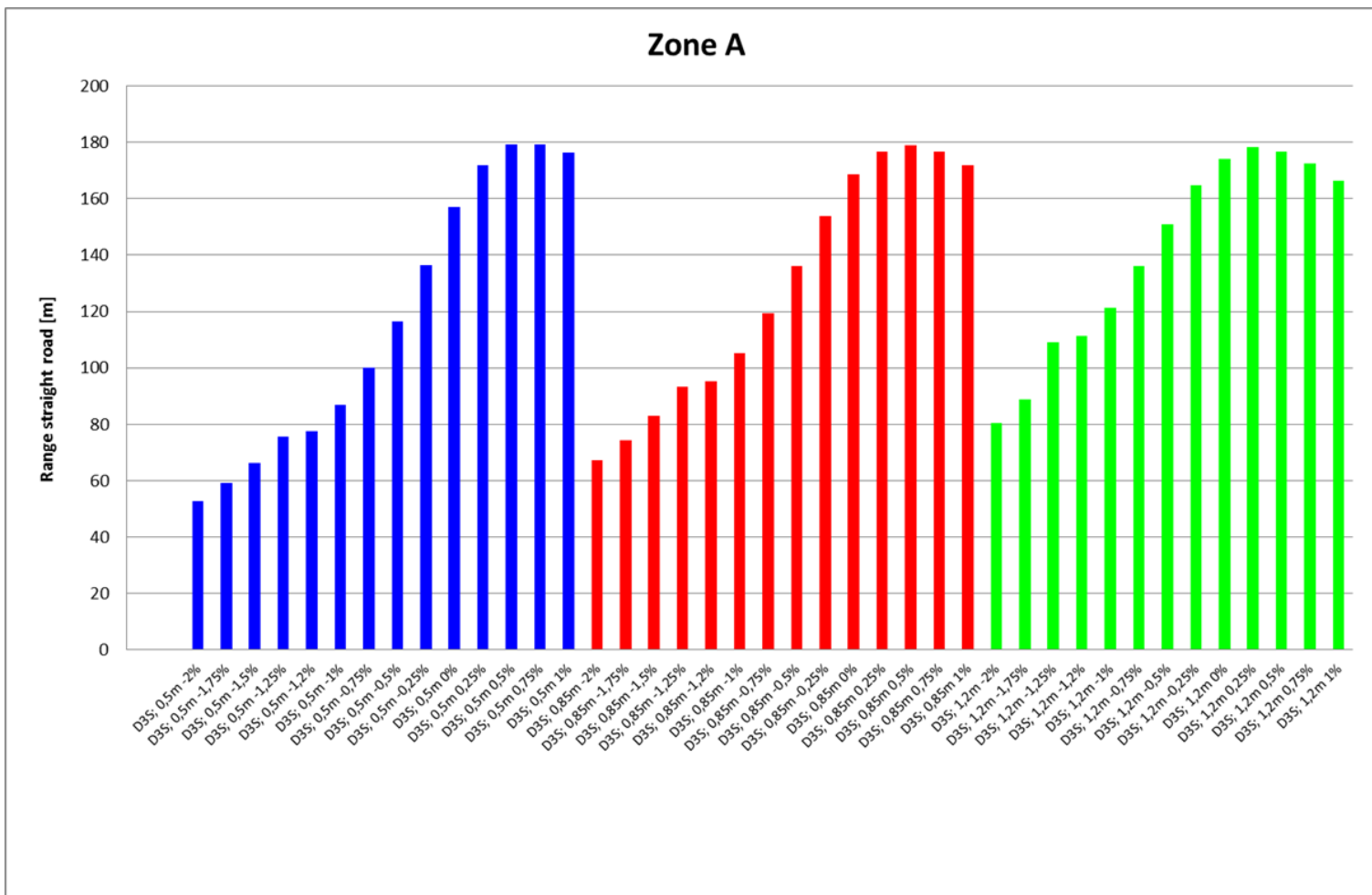

# CIE TC4-45

Performance Assessment Method  
for Vehicle Headlamps

## Range in Zone A – LED headlamp at different mounting heights

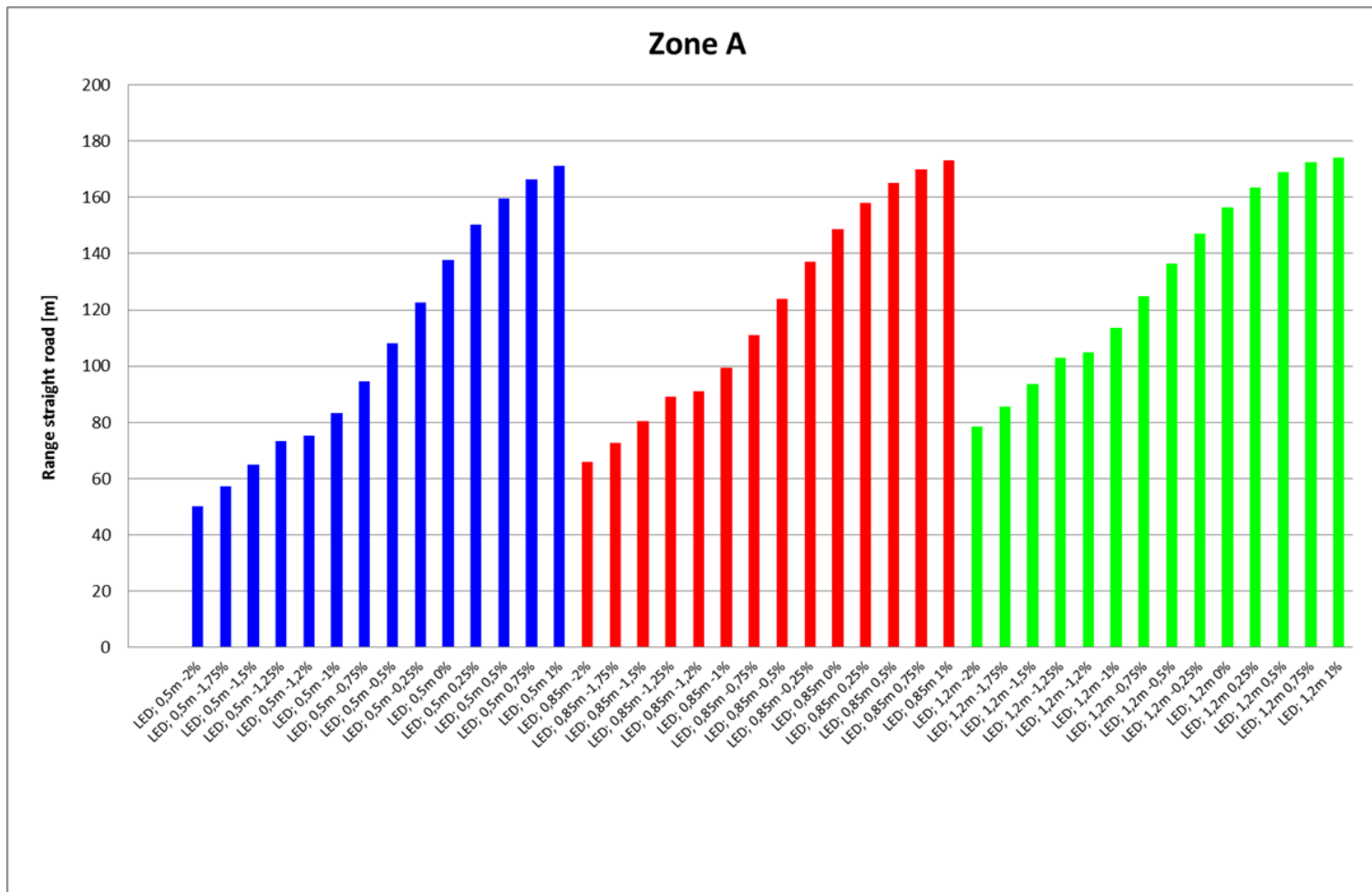

## Headlamp Glare

---

# Calculation Results in Relation to Klettwitz Field Test Outcome

---

## Headlamp Glare – correlation between de Boer and Luminous Flux

---

- The results of the Klettwitz field test show a clear relationship between pitch angle and discomfort glare.
- Pitch angles which lead to a passing beam cut-off movement above the horizon increase the discomfort glare for oncoming drivers – depending on the headlamps mounting height – to values below rating 5 („just admissible“) according to de Boer – scale.
- Cut-off positions above horizon lead – undependendly of light source types – to weighted luminous flux values in TC4-45 glare zone above 1 lumen.

# CIE TC4-45

Performance Assessment Method  
for Vehicle Headlamps

## Headlamp Glare – correlation between de Boer and Luminous Flux

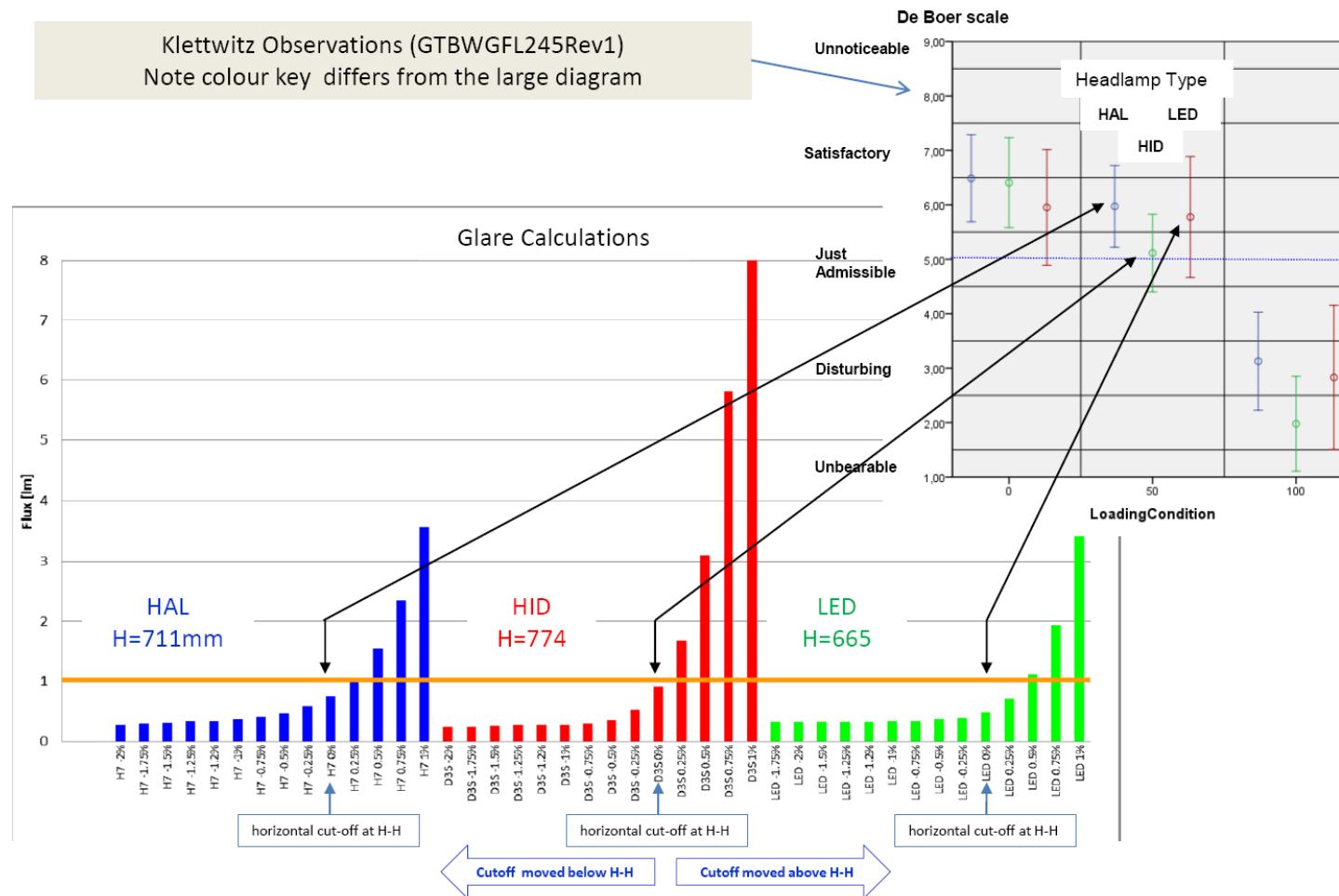

## Headlamp Glare – correlation between de Boer and Luminous Flux

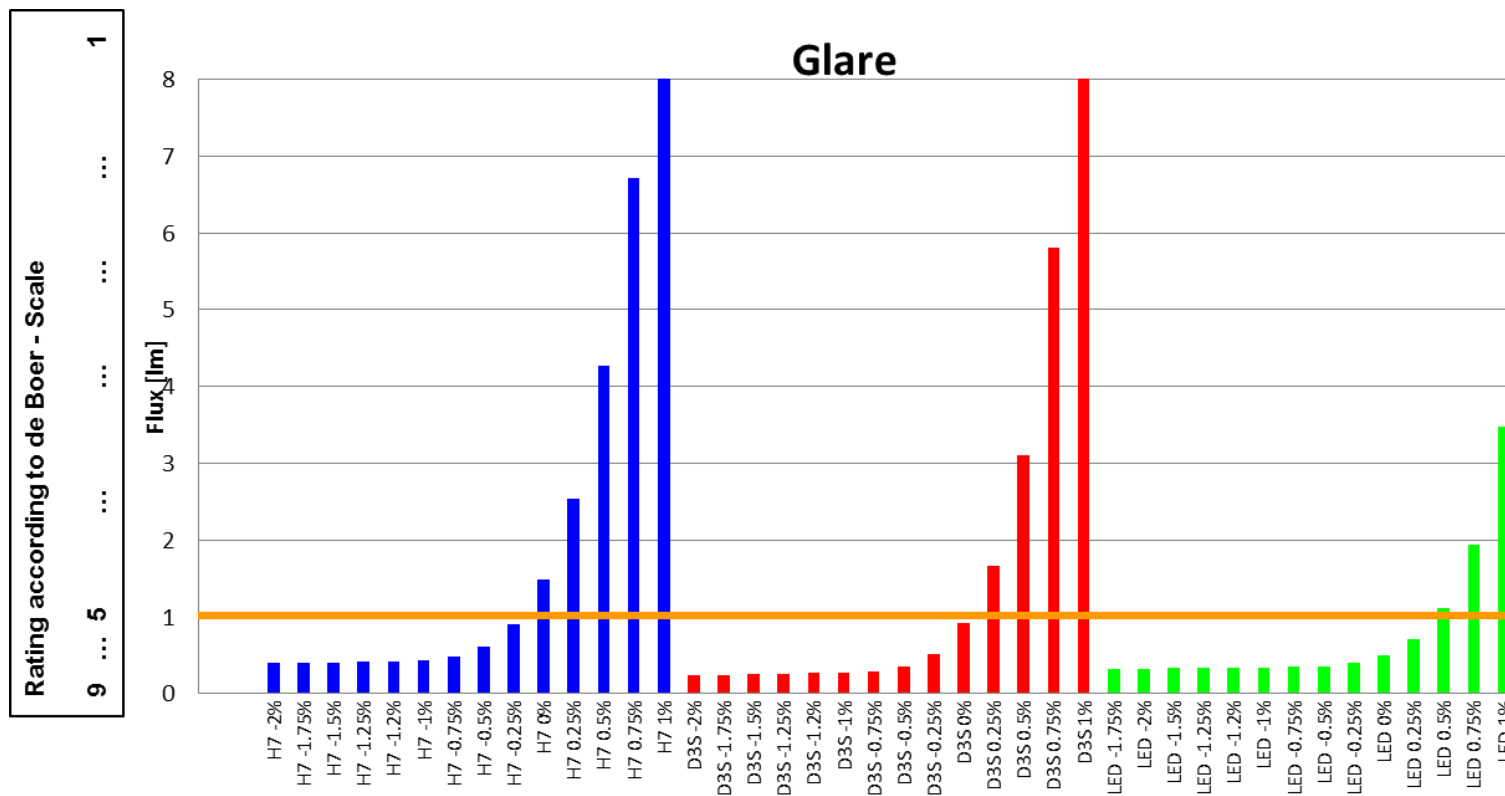

---

## Headlamp Glare – correlation between de Boer and Luminous Flux

---

- **Comparison of Klettwitz field test results and TC4-45 calculations leads to the conclusion that de Boer-Rating of „5 – just admissible“ correlates with a weighted luminous flux in TC4-45 glare zone of 1 lumen.**
- **This correlation opens the possibility to use TC4-45 glare calculations for the assessment of glare impact to oncoming drivers in real traffic situations.**



# Summary and Suggestion for Amendment to UN Regulation No. 48

Geoffrey R Draper - GTB President

*Headlamp levelling is a challenging subject because glare complaints are inherent to visibility of the road ahead for the driver.  
There is no perfect answer!*

- Vehicle pitch is the influencing factor
- Glare remains acceptable providing the horizontal cutoff remains below the H-H line as defined in the headlamp regulations (Based on a mounting height of 750mm).
- It is necessary to consider the relationship between action to avoid glare complaints with the need to assure sufficient visibility range.
- The initial aim declared by the vehicle manufacturer becomes an important factor
- Data produced to enrich the Klettwitz results to validate the glare conclusions and investigate the relationship with visibility range
- Calculations using the CIE assessment method

## Example calculations using the CIE assessment method

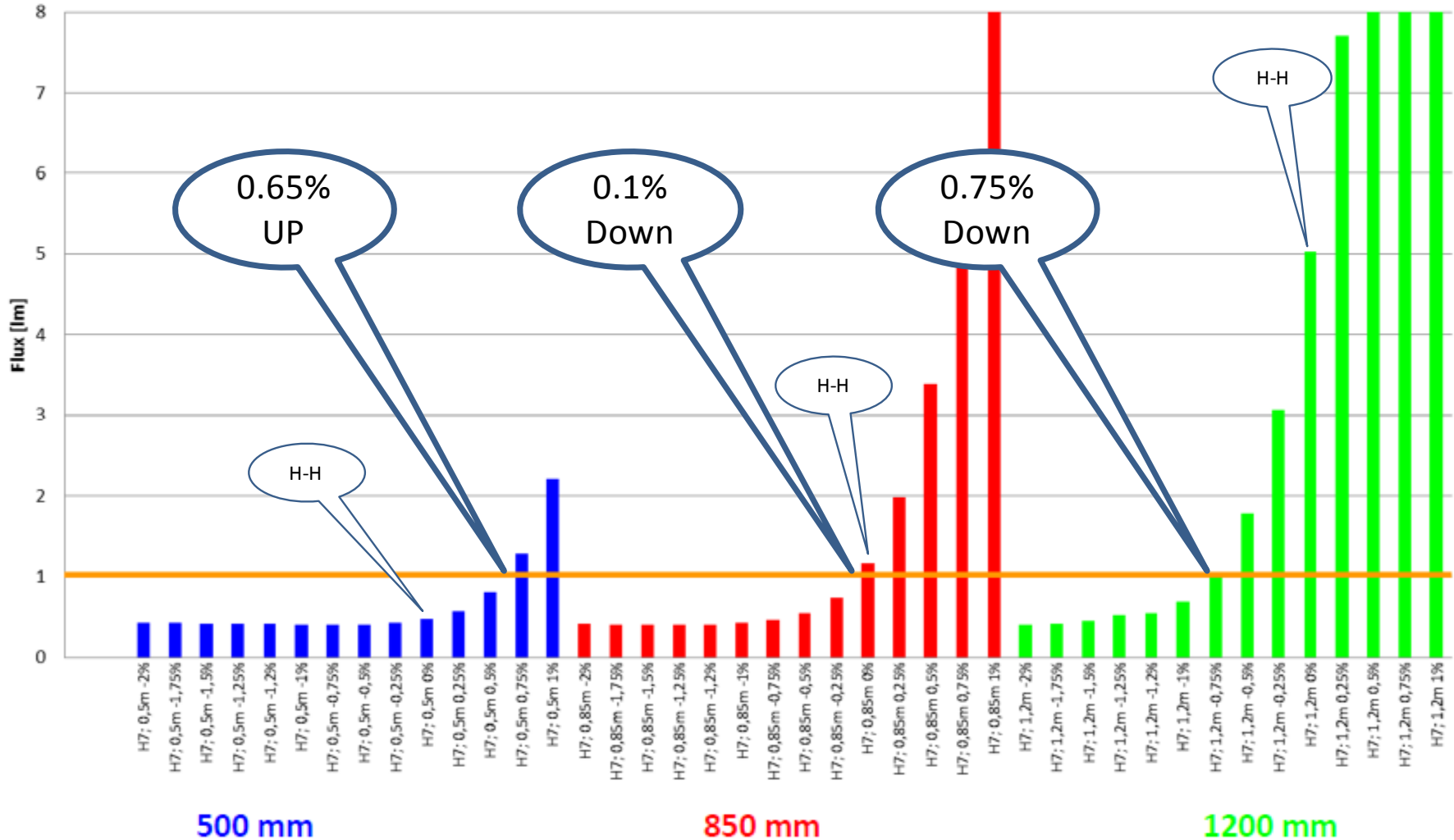

# Example calculations using the CIE assessment method

## Visibility Range Calculation

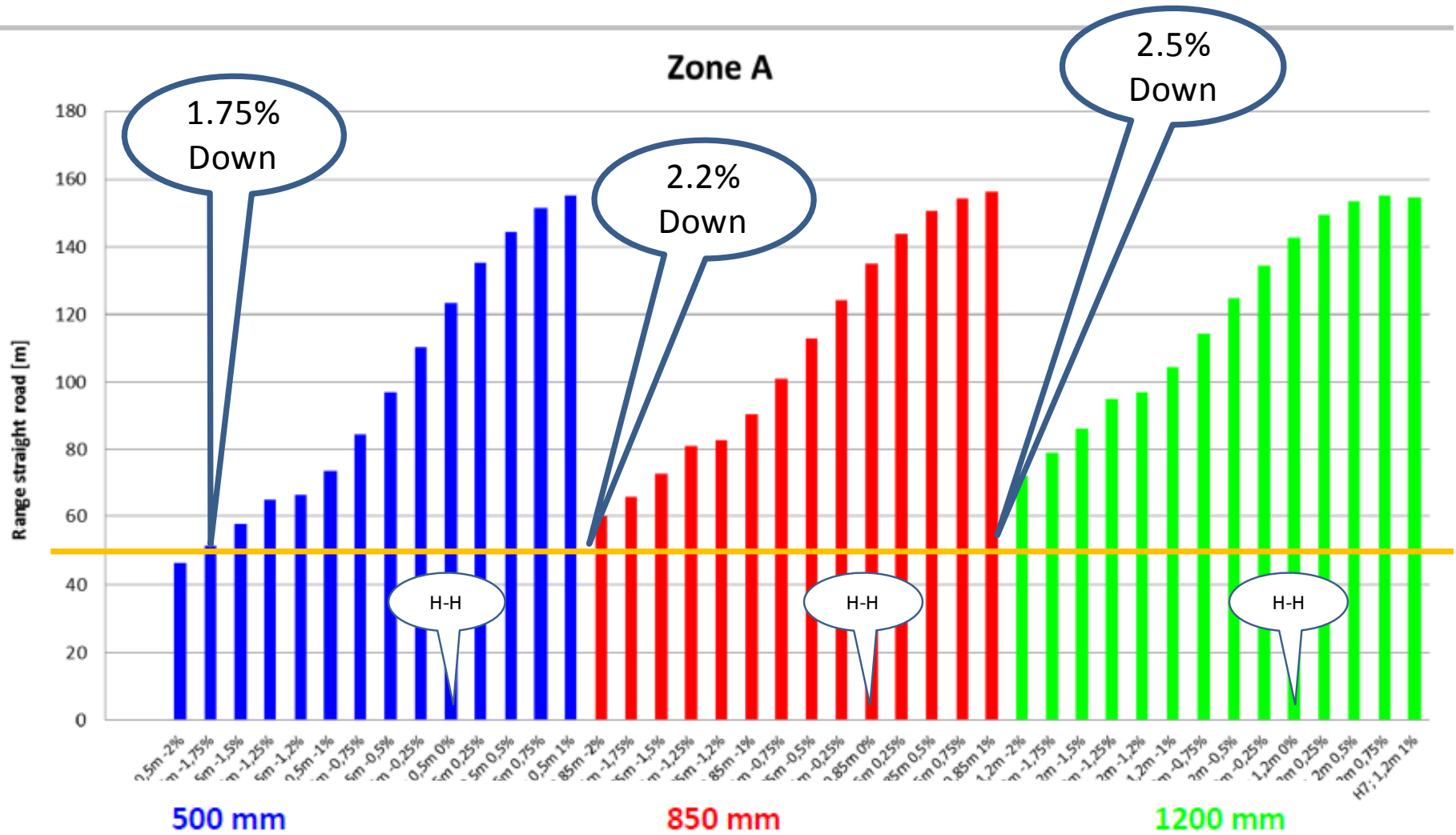

# GTB Proposal for Acceptable aiming limits

## Summary of Results of Glare and Visibility Calculations Based upon calculations using CIE method

Vertical Position of the Cutoff (+ = UP, - =Down)

Mounting Height	H7		D3S		LED	
	Glare	Visibility	Glare	Visibility	Glare	Visibility
500	0.65	-1.75	0.6	-2.2	0.5	-2
665					0.4	-2
744			0.12	-2.25		
850	-0.1	-2.25	-0.12	-2.25	-0.2	-2.5
907	-0.15	-2.25				
1200	-0.75	-2.5	-0.85	-3.25	-0.85	-3

The highlighted values indicate the position of the cutoff for the maximum permissible glare and the minimum permissible visibility range (i.e. The boundary conditions)

# GTB Proposal for Acceptable aiming limits

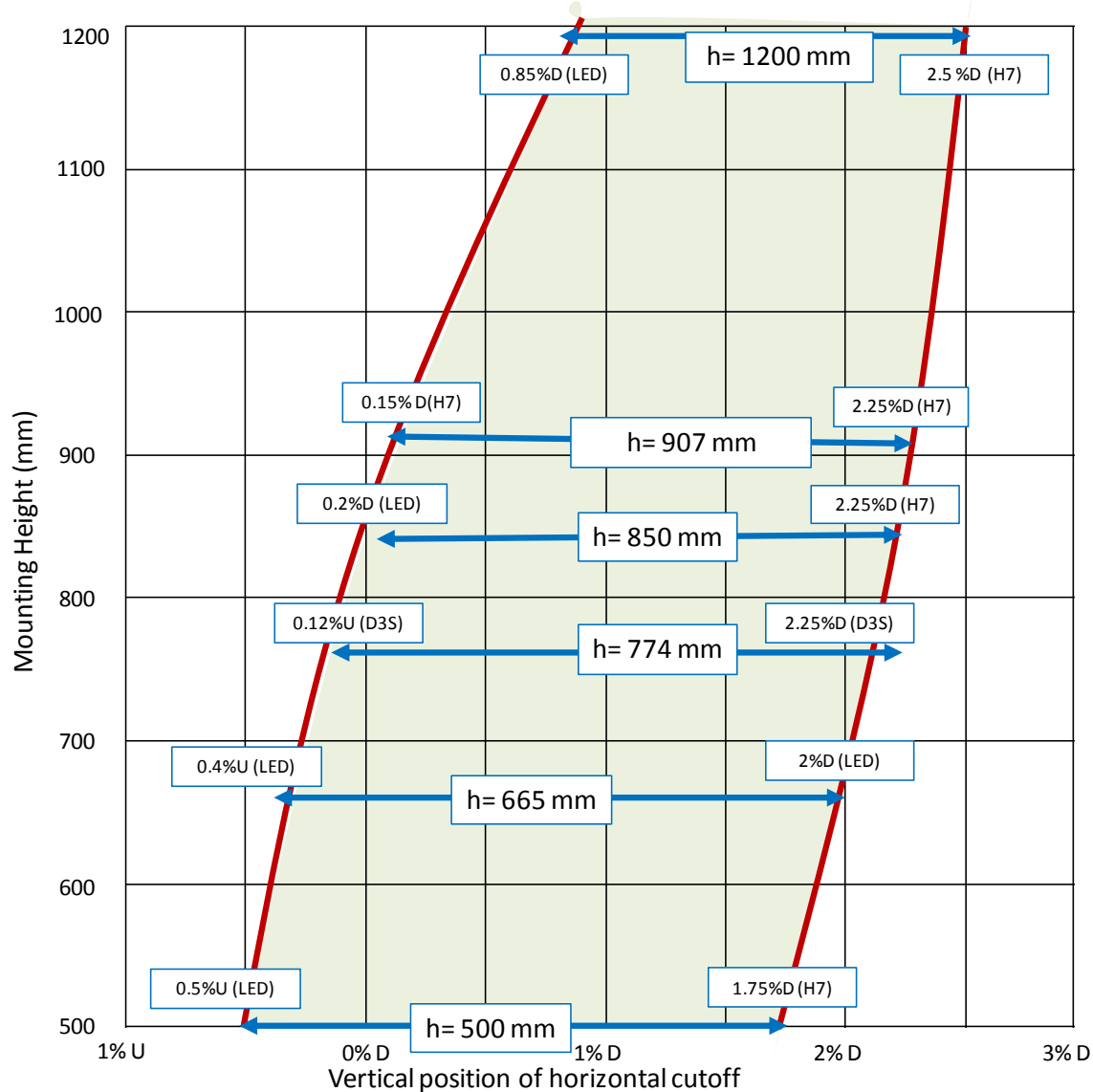

# GTB Proposal for Acceptable aiming limits

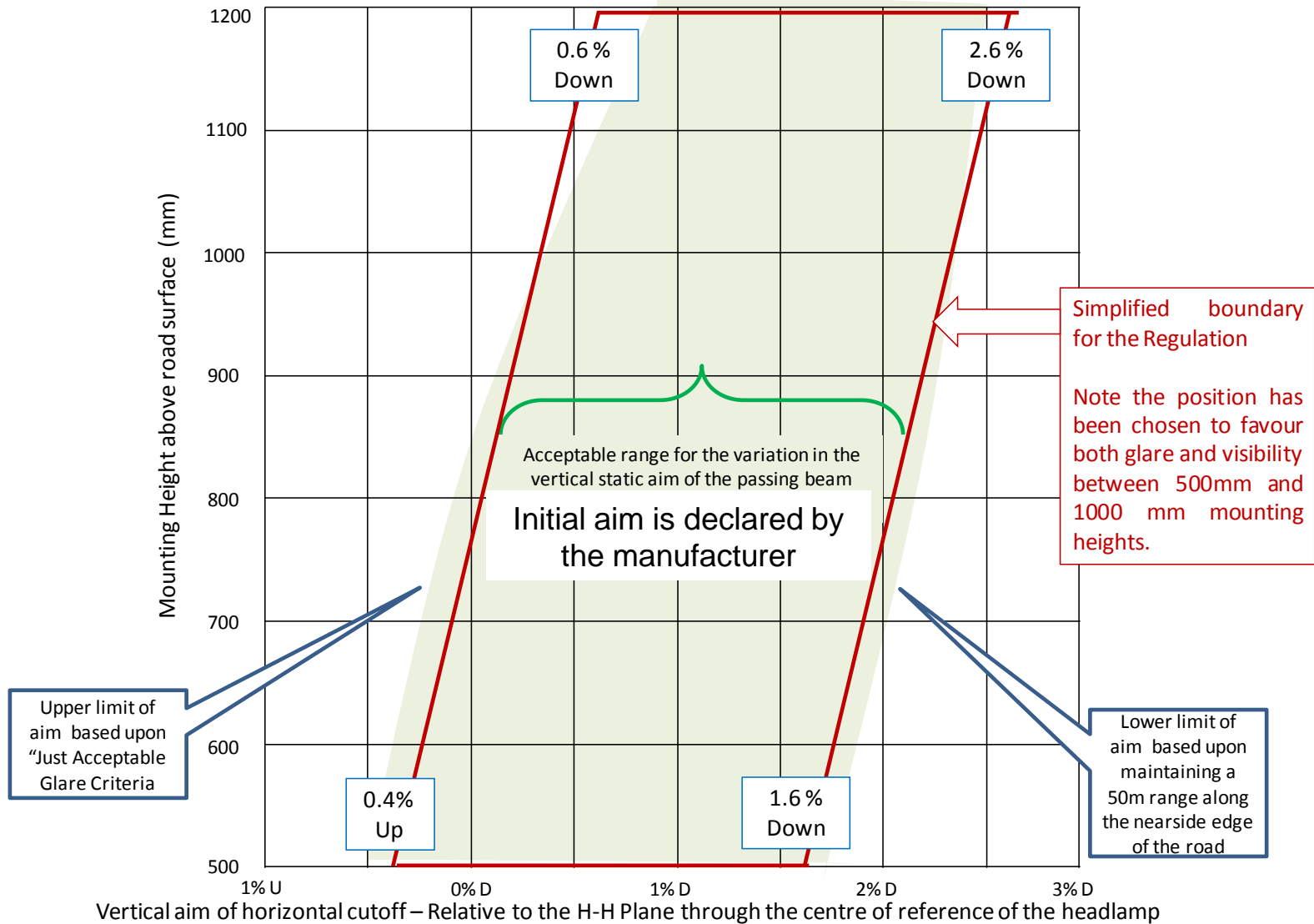

# GTB Task Force

## Coordination of **A**utomotive **V**isibility and **G**lare **S**tudies

Thank you for your attention

