

Date 03-09-2016

**SLR-18-04**

## Agreement

Concerning the adoption of uniform technical prescriptions for wheeled vehicles, equipment and parts which can be fitted and/or be used on wheeled vehicles and the conditions for reciprocal recognition of approvals granted on the basis of these prescriptions\*

(Revision 2, including the amendments which entered into force on 16 October 1995)

## Addendum XX: Regulation No. XX

### Draft New Simplified UN Regulation on Retro-Reflecting Devices (RRD)

This text is NOT the final version. It is intended to show how the new RRD Regulation will look like with the purpose of collecting constructive comments from those CPs usually not attending SLR meetings.

**PLEASE SUBMIT YOUR COMMENTS BY  
FRIDAY, THE 7<sup>TH</sup> OF JULY 2017**



UNITED NATIONS

\* Former title of the Agreement: Agreement Concerning the Adoption of Uniform Conditions of Approval and Reciprocal Recognition of Approval for Motor Vehicle Equipment and Parts, done at Geneva on 20 March 1958.

## Regulation No. XX

### **Uniform provisions concerning the approval of retro-reflecting devices and markings for power-driven vehicles and their trailers**

#### Contents

Regulation	<i>Page</i>
0. Scope	
1. Definitions	
3. Administrative Provisions	
3. General technical specifications	
4. Specific Technical Requirements	
4.1. Retro-reflectors of the Classes IA and IB	
4.2. Retro-reflectors of the Classes IIIA and IIIB	
4.3. Retro-reflectors of the Classes IVA	
4.4. Retroreflective Markings of the Class C	
4.5. Retroreflective Markings of the Classes D and E	
4.6. Retroreflective Markings of the Class F and Retroreflective Markings Plates of the Class 5	
4.7. Retroreflective Markings Plates of the Classes 1, 2, 3 and 4	
4.8. Retroreflective Markings Plates for slow moving vehicles of the Class SMV	
4.9. Advance Warning Triangles of Type 1 and 2	
5. Conformity of Production	
6. Modifications and Extensions	
7. Penalty for non-conformity of Production	
8. Production definitively discontinued	
9. Name and Adresse of the Technical Service	
10. Transitional Provisions	

## **Annexes**

1. Communication
2. Minimum requirements for conformity of production control procedures
3. Minimum requirements for sampling by an inspector
4. Photometric measurements
5. Specifications of shape and dimensions
6. Resistance to heat
7. Resistance to water penetration
8. Resistance to dirt
9. Resistance to fuels
10. Resistance to lubricating oils
11. Resistance to corrosion
12. Resistance of the accessible rear face of mirror-backed retro-reflecting devices
13. Resistance to weathering
14. Stability in time of the optical properties of retro-reflecting devices
15. Resistance to cleaning
16. Bonding strength
17. Flexing
18. Resistance to impact
19. Rigidity of plates
20. Further test procedure for Advance Warning Triangles of Type 1 and 2
21. Colour fastness of retro-reflecting devices of the classes IA to IVA
22. Colour fastness to artificial light – Xenon Arc Test
23. Description of the measurement geometry for measurement of the colour and the luminance factor of fluorescent retro-reflective materials
24. Examples of arrangement of approval marks

## 0. Scope

This Regulation applies to Retro-reflecting devices and markings as:  
Retro-reflectors of the Classes IA, IB, IIIA, IIIB and IVA  
Retroreflective Markings of the Classes C, D, E and F  
Retroreflective Markings Plates of the Classes 1, 2, 3, 4 and 5  
Retroreflective Markings Plates for slow moving vehicles of the Class Triangle  
Advance Warning Triangles of Type 1 and 2

## 1. Definitions

For the purpose of this Regulation:

**1.1 "Retro-reflecting devices as retro-reflectors or retroreflective materials or marking plates or Advance warning triangles of different type" means devices, which differ in such essential respects as:**

**ECE/TRANS/WP.29/GRE/2014/3**

- a) the trade name or mark:
- (i) **retro-reflectors or retroreflective materials or marking plates or Advance warning triangles bearing the same trade name or mark but produced by different manufacturers are considered as being of different types;**
  - (ii) **retro-reflectors or retroreflective materials or marking plates or Advance warning triangles produced by the same manufacturer differing only by the trade name or mark are considered as being of the same type.**
- b) **the characteristics of the optical system (levels of intensity, light distribution angles, inclusion or elimination of components capable of altering the optical effects by reflection, refraction, absorption and/ or deformation during operation, etc.);**
- 1.2 A type of "retro-reflecting device" is defined by the models and descriptive literature submitted with the application for approval. Retro-reflecting devices can be considered as belonging to the same type if they have one or more "retro-reflecting optical units" which are identical with those of the standard model, or if not identical are symmetrical and suitable for mounting one on the left and one on the right side of the vehicle, and if their other parts differ from those of the standard model only in ways not affecting the properties to which **this Regulation** applies. In the case of retro-reflectors or retroreflective materials of the Class "D" and "E" which differ only in the A change of colour of the light source or the colour of any filter emitted does not constitute a change of type.**

1.3 "Materials and/or Plates or Advance warning triangles of different types" means materials and/or marking plates or Advance warning triangles which differ in such essential respects as:

- a) described in paragraph 1.1.;
- b) the optical characteristics of the retro-reflective material or, if applicable, of the retro-reflecting device;
- c) the characteristics of the fluorescent material, if applicable;
- d) the parts affecting the properties of the retro-reflective materials and/or plates;
- e) the distinctive geometrical and mechanical features of the design (only for plates/devices corresponding to the paragraphs 4.8. to 4.9.).

For materials and/or plates corresponding to the paragraphs 4.4. to 4.7., differences in the shape and dimensions of the marking shall not constitute a different type.

1.4 All the definitions given in UN Regulation No. 48 and its series of amendments in force at the time of application for type approval shall apply, and in addition :

**1.5 Definition with regard to retro-reflectors:**

1.5.1. "*Retro-reflection*" means the reflection in which radiation is returned in directions close to the direction from which it came, this property being maintained even over wide variations of the direction of the incident radiation:

1.5.2. "*Retro-reflecting device*" means an assembly ready for use and comprising one or more retro-reflecting optical units;

Retro-reflecting devices are divided into three classes according to their photometric characteristics: Class IA or IB, Class IIIA or IIIB, and Class IVA.

Retro-reflecting devices of Classes IB and IIIB are devices combined with other signal lamps which are not watertight and which are integrated into the body of a vehicle.

**1.6. Definition with regard to *Retro-reflective marking*:**

1.6.1. "*Retro-reflective marking material*" means a surface or a device from which, when directionally illuminated, a relatively large portion of the incident radiation is retro-reflected.

1.6.2. "*Rear marking plate*" means a plate faced with retro-reflective and fluorescent material or devices intended to increase the visibility and permit easy identification of heavy and long vehicles.

1.6.3. "*Slow moving vehicle (SMV) rear marking plate*" means a triangular plate with truncated corners with a characteristic pattern faced with **retro-reflectors or retro-reflective materials and retro-reflective or** fluorescent material

1.6.4. "*Sample unit*" means a complete, finished **marking plate (e.g. SMV or other)** ready to be mounted on a vehicle and representative of current production.

1.6.5. "*Fluorescence*" means when certain substances are brought near to a source of ultraviolet or blue radiations, they emit radiations which are nearly always of longer wave-length than those producing the effect. This phenomenon is called fluorescence. By day and in twilight, fluorescent colours are brighter than normal colours because they reflect part of the light falling upon them, and in addition they emit light. At night they are not brighter than ordinary colours.

## 2. ADMINISTRATIVE PROVISIONS

### 2.1. Application for approval

2.1.1 The application for type approval shall be submitted by the holder of the trade name or mark or by his duly accredited representative.

2.1.2 It shall be accompanied by:

2.1.2.1. the documents and sample(s) indicated in paragraphs 2.3. to 2.7. and related subparagraphs;

2.1.2.2. the "Communication concerning approval" provided in Annex 1 to this Regulation

**2.1.2.3** drawings, sufficiently detailed to permit identification of the type and, if applicable, of the category of the lamp, showing:

- a) geometrically in what position(s) the lamp (and if applicable for category S3 or S4 lamps the rear window) may be mounted on the vehicle;
- b) the axis of observation to be taken as the axis of reference in the tests (horizontal angle  $H = 0^\circ$ , vertical angle  $V = 0^\circ$ ); and the point to be taken as the centre of reference during the tests;
- c) the limit of the apparent surface of the function(s);
- d) the position intended for the approval number and the additional symbols in relation to the circle of the approval mark;
- e) in case of LED module(s) also the space reserved for the specific identification code(s) of the module(s);
- f) in the case of an interdependent lamp system, the interdependent lamp or the combination of interdependent lamps;

**2.1.2.4.** a brief technical description stating in particular, with the exception of lamps with non-replaceable light sources:

- a) the category or categories of filament light source(s) prescribed; this filament light source category shall be one of those contained in UN Regulation No. 37;
- b) the category or categories of LED lamp(s) prescribed; this LED light source category shall be one of those contained in UN Regulation No. 128;
- c) the light source module specific identification code;

**ECE/TRANS/WP.29/GRE/2014/3**

2.1.2.5. However, in the case of a type of **retro-reflectors or retroreflective materials or marking plates or Advance warning triangeles** differing only by the trade name or mark from a type that has already been approved it is sufficient that the application is accompanied by:

2.1.2.5.1. a declaration by the retro-reflectors or retroreflective materials or marking plates or Advance warning triangeles manufacturer that the type submitted is identical (except in the trade name or mark) with and has been produced by the same manufacturer as the type already approved, the latter being identified by its approval code;

- 2.1.2.5.2. two samples bearing the new trade name or mark or equivalent documentation.
- 2.1.2.8. at the discretion of the applicant, the description may specify if the device may be installed on the vehicle with different inclinations of the reference axis in respect to the vehicle reference planes and to the ground, or rotate around its reference axis; these different conditions of installation shall be indicated in the communication form.
- 2.1.2.9. If not otherwise specified for the relevant **retro-reflectors or retroreflective materials or marking plates or Advance warning triangeles**, the following samples:
- a) two complete samples of the device.  
If application is made for the approval of lamps which are not identical but are symmetrical and suitable for mounting one on the left and one on the right side of the vehicle, the two samples submitted may be identical and be suitable for mounting only on the right or only on the left side of the vehicle.

2.1.2.10. In the case of a .....

## 2.2 Approval

- 2.2.1. If the lamp(s) submitted for approval in pursuance of paragraph 2.1. meet the requirements of this UN Regulation:
- 2.2.1.1. approval shall be granted;
- 2.2.1.2. notice of approval or of extension or refusal or withdrawal of approval of a type of a device pursuant to this UN Regulation shall be communicated to the Contracting Parties to the 1958 Agreement which apply this UN Regulation, by means of a form conforming to the model in Annex 1 to this UN Regulation;
- 2.2.1.3. an approval number shall be assigned to each type approved and shall be marked on the device following the requirements of Paragraph 2.3. [The same Contracting Party shall not assign the same number to another type of device of the same function.]

## 2.3 Markings

- 2.3.1. Every device belonging to an approved type shall comprise a space of sufficient size for the approval mark prescribed in paragraph 2.2.1.3.
- 2.3.2. Composition of the approval mark

The approval mark shall consist of:

- 2.3.2.1. a circle surrounding the letter "E" followed by the distinguishing number of the Contracting Party [to the 1958 Agreement] which has granted approval;<sup>1</sup>

---

<sup>1</sup> The distinguishing numbers of the Contracting Parties to the 1958 Agreement are reproduced in Annex

2.3.2.2. the number of the pertinent Regulation, followed by the letter "R", a dash and the approval number prescribed in paragraph 2 above,. The first two digits of the approval number indicate the series of amendments in force at the time of issue of the approval;

2.3.2.3. **the symbols identifying the retro-reflecting device, marking materials or plates and the additional symbols prescribed in paragraphs 2.2.**

2.3.2.4. **The approval mark shall be clearly legible and indelible.**

2.3.2.5. The approval number and the **additional** symbols shall be placed close to the circle prescribed in paragraph 2.2. and either above or below the letter "E", or to the right or left of that letter. The digits of the approval number shall be on the same side of the letter "E" and face the same direction. The use of Roman numerals as approval numbers should be avoided so as to prevent any confusion with other symbols.

2.3.2.6. Examples of the arrangement of vehicle and devices **marking** are shown in **Annex 6**.

2.3.4. In the case of a **retro-reflecting device, marking materials or plates**

2.3.4.1. **general prescriptions on marking**

2.3.4.1.1. **the space for the approval mark shall be shown in the drawings mentioned in paragraph 2.1.3.1.;**

2.3.4.1.2. the approval mark, **shall** be placed on an inner or outer part (transparent or not) of the device which cannot be separated from the transparent part of the device emitting the light. In any case the marking shall be visible when the device is fitted on the vehicle or when a movable part such as the hood or boot lid or a door is opened.

**The "Other markings" indicated in paragraphs 5.5. and 5.6. shall be affixed, in indelible and clearly legible manner, on the lamp but does not need to fulfil the requirements of this paragraph.**

2.3.4.1.3. in the case where a **retro-reflecting device is** grouped, combined or reciprocally incorporated **with** lamps, a single approval mark may be applied, provided that all the grouped, combined or reciprocally incorporated lamps satisfy any one of the pertinent Regulations and that the following requirements are also fulfilled:

---

3 to the Consolidated Resolution on the Construction of Vehicles (R.E.3), document ECE/TRANS/WP.29/78/Rev.2/Amend.3  
[www.unece.org/trans/main/wp29/wp29wgs/wp29gen/wp29resolutions.html](http://www.unece.org/trans/main/wp29/wp29wgs/wp29gen/wp29resolutions.html)



- (a) requirements of **paragraph 4.4.2.** apply;
- (b) no part of the grouped, combined or reciprocally incorporated lamps that transmits light can be removed without at the same time removing the approval mark;
- (c) the symbols for each [~~lamp~~] **[function]**, prescribed in **paragraphs 2.2.**, appropriate to each Regulation under which approval has been granted, shall be marked:
  - either on the appropriate light-emitting surface;
  - or in a group, in such a way that each [~~lamp~~] **[function]** of the grouped, combined or reciprocally incorporated lamps may be clearly identified,
- (d) the size of the components of a single approval mark shall not be less than the minimum size required for the smallest of the individual marks by the pertinent Regulation -

**2.3.4.1.4.** in the case of different types of lamps complying with the requirements of several Regulations, which use the same outer lens having the same or different colour, a single approval mark may be provided that:

- (a) the symbols for each [~~lamp~~] **[function]**, prescribed in **paragraphs 2.2.** appropriate to each Regulation under which approval has been granted, are marked in conformity to **paragraph 4.4.2.;**
- (b) the main body of the lamp shall bear the approval mark of the actual function(s);
- (c) the size of the components of a single approval mark shall not be less than the minimum size required for the smallest of the individual marks by the pertinent Regulation.

[2.3.4.1.5. In the case of lamps grouped, combined or reciprocally incorporated with other lamps the lens of which may also be used for other types of lamps both the provisions of **paragraphs 4.4.3 and 4.4.4.** apply.]

2.3.5.1. Symbols, prescribed by **paragraph 5.2.3.**, identifying the light signalling function(s) for which type approval has been granted:

**Table 1: List of retro-reflective devices and their identification symbols**

Retro-reflective devices	Identification symbol
Retro-reflector for motor vehicles (independent)	IA
Rear retro-reflector for motor vehicles (combined with other signal lamps which are not watertight)	IB
Retro-reflector for trailers (independent)	IIIA
Rear retro-reflector for trailers (combined with other signal lamps which are not watertight)	IIIB
Rear wide angle retro reflector	IVA
Conspicuity marking (material for contour/strip marking)	C
Conspicuity marking (material for distinctive markings/graphics intended for a limited area)	D
Conspicuity marking (material for distinctive markings/graphics intended for an extended area)	E
Conspicuity marking (materials for distinctive markings or graphics as base or background in printing process for fully coloured logos and markings of class "E" in use which fulfil the requirements of class "D" materials)	D/E
Retro reflecting marking for long or heavy vehicles (retro-reflective and fluorescent materials)	RF
Retro reflecting marking for long or heavy vehicles (retro-reflective only materials)	RR
Marking for slow moving vehicles (retro-reflective and fluorescent materials)	RF
Marking for slow moving vehicles (retro-reflective only materials)	RR
Advance Warning Triangle	-

**2.3.5.2. Additional symbols, prescribed by paragraph 5.2.3.:**

In the case of devices which cannot be mounted on either side of the vehicle indiscriminately:

- a horizontal arrow directed outwards from the vehicle on front or rear devices ;
- a horizontal arrow directed towards the front of the vehicle on side direction indicator lamps of category 5 and 6 and on parking lamps emitting light of amber colour towards the front and rear;
- an indication "R" or "L", indicating the right or left side of the vehicle, shall be added on side direction indicator lamps of category 6;

**2.3.5.2.2.** in the case of devices which may be used as part of an assembly of two lamps, the letter "D" shall be added to the right of the symbol identifying the lighting function;

### 3. GENERAL REQUIREMENTS WITH REGARD TO RETRO-REFLECTING DEVICES

- 3.1. For the purpose of this Regulation, retro-reflectors or retroreflective materials or marking plates or advance warning triangles for general descriptions herein after referred to as "retro-reflecting devices".
- 3.1.1. **Retro-reflecting devices** shall be so constructed that they function satisfactorily and will continue to do so in normal use. In addition, they must not have any defect in design or manufacture that is detrimental to their efficient operation or to their maintenance in good condition.
- 3.1.2. The components of retro-reflecting devices or parts thereof shall not be capable of being easily dismantled.
- 3.1.3. The means of attachment of the marking materials shall be durable and stable.
- 3.1.4.. The outer surface of **retro-reflecting devices** shall be easy to clean. The surface shall therefore not be rough and any protuberances they may exhibit shall not prevent easy cleaning.
- 3.1.5. There shall be no access to the inner surface of the retro-reflectors when in normal use.
- 3.1.6. Retro-reflecting devices may consist of a combined retro-reflecting optical unit and filter, which must be so designed that they cannot be separated under normal conditions of use.
- 3.1.7. The colouring of retro-reflecting optical units and filters by means of paint or varnish is not permitted.
- 3.1.8. Test procedures for retro-reflecting devices:

#### 3.2. Colorimetric test conditions

- 3.2.1. Test procedure for night time colours:
- 3.2.1.1. These specifications shall apply only to clear, red or amber retro-reflecting devices
- 3.2.1.2. For testing the colour of the retro-reflecting device, this device shall be illuminated by the CIE Standard Illuminant A, with an angle of divergence of 1/3 degrees and an illumination angle of  $V = H = 0$  degree, or, if this produces a colourless surface reflection, an angle  $V = +/- 5$  degrees,  $H = 0$  degree, the trichromatic coordinates of the reflected luminous flux must be within the limits according to the specifications for the individual retroreflecting device in **paragraph 4.**
- 3.2.1.3. Clear retro-reflecting devices must not produce a selective reflection, that is to say, the trichromatic coordinates "x" and "y" of the standard illuminant "A" used to illuminate the retro-reflecting device must not undergo a change of more than 0.01 after reflection by the retro-reflecting device.
- 3.2.2. Test procedure for day time colours:

- 3.2.2.1. For testing the day time colour of the materials, the material shall be illuminated by the CIE Standard Illuminant D 65 at an angle of 45° to the normal and viewed (measured) along the normal (45/0 geometry), with a spectrophotometer in accordance with the provisions of CIE document No. 15 (1971).

The colour of the material in new condition shall be within the limits according to the specifications for the individual retro-reflecting device in [paragraph 4](#).

- 3.2.3. Test procedure for fluorescent colours:

- 3.2.3.1. Colour of the fluorescent material without retro-reflection:

- 3.2.3.1.1. For testing the colour of the fluorescent material, the material shall be illuminated by the CIE Standard Illuminant D65 (ISO 11664-2:2007(E)/CIE S 014-2/E:2006) and measured with a spectrophotometer in accordance with the provisions of Publication CIE 15:2004, Recommendations on Colorimetry - Second Edition, either illuminated polychromatically or with a monochromator providing stepwise the CIE Standard Illuminant D 65 (ISO 11664-2:2007(E)/CIE S 014-2/E:2006) at an angle 45° to the normal and viewed along the normal (geometry 45/0). In the latter case, the stepwise resolution  $\Delta\lambda$  shall be not larger than 10 nm. Alternatively similar "illuminants" are allowed, if verified that the colorimetric measuring procedure is of the same sufficient accuracy, meaning that the quality of the simulation of D65 shall be assessed by the method described in ISO 23603:2005(E)/CIE S 012/E:2004. The spectral distribution of the illuminant shall be in category BC (CIELAB) or better.

The illumination shall be carried out at an angle 45° to the normal and viewed along the normal (geometry 45/0).

- 3.2.3.2. Colour of the fluorescent material with retro-reflection:

- 3.2.3.2.1. For testing the colour of the fluorescent material, the material shall be illuminated by the CIE Standard Illuminant D65 (ISO 11664-2:2007(E)/CIE S 014-2/E:2006) and measured with a spectrophotometer in accordance with the provisions of publication CIE 15:2004, Recommendations on Colorimetry - second edition, either illuminated polychromatically or with a monochromator providing stepwise the CIE Standard Illuminant D 65 (ISO 11664-2:2007(E)/CIE S 014-2/E:2006). In the latter case, the stepwise resolution  $\Delta\lambda$  shall be not larger than 10 nm. Alternatively similar "illuminants" are allowed, if verified that the colorimetric measuring procedure is of the same sufficient accuracy, meaning that the quality of the simulation of D65 shall be assessed by the method described in ISO 23603:2005(E)/CIE S 012/E:2004. The spectral distribution of the illuminant shall be in category BC (CIELAB) or better. The illumination shall be carried out circumferential at an angle 45° to the normal and viewed along the normal (annular geometry 45/0) (circumferential/normal geometry), as described [in Annex 23](#).

- 3.3. Determination of the luminance factor:

- 3.3.1. For the determination of the luminance factor, the sample shall be tested

- (a) For retro-reflective devices without fluorescens (day time colours) and fluorescent material without retro-reflection with the same method as described in paragraph 3.2.4.1.;
- (b) For fluorescent material with retro-reflection with the same method as described in paragraph 3.2.4.2..

3.3.1.1 By putting the luminance  $L$  of the sample into relation to the luminance  $L_o$  of a perfect diffuser whose luminance factor  $\beta_o$  is known under identical conditions of illumination and observation; the luminance factor  $\beta$  of the sample then results from the formula:

$$\beta = \frac{L}{L_o} \cdot \beta_o$$

3.3.1.2. When the colour of the fluorescent material has been colorimetrically determined in compliance with paragraph 3.3., from the ratio of the tristimulus value  $Y$  the sample and the tristimulus value of the perfect diffuser  $Y_o$ ; in this case it is:

$$\beta = \frac{Y}{Y_o}$$

## 4. Specific Technical Requirements

### 4.1 Technical requirements concerning retro-reflectors of the Classes IA and IB (symbols "IA" and "IB")

4.1.1. Every retro-reflector of the Classes IA and IB, when tested according to paragraph 4.1.3., shall meet:

- the dimensions and shape requirements set forth in Annex 5, and
- the photometric and colorimetric requirements as specified in paragraphs 4.1.4. to 4.1.5. and
- the physical and mechanical requirements set forth in paragraph 4.1.6, depending on the nature of the materials and construction of the retro-reflecting devices

4.1.2. The applicant shall submit ten samples for approval which shall be tested in the chronological order as indicated in paragraph 4.1.7.

4.1.3. Test procedure.

4.1.3.1. After verification of the general specifications (paragraph 2.) and the specifications of shape and dimensions (Annex 5), the ten samples shall be subjected to the heat resistance test described in Annex 6 and at least one hour after this test examined as to their colorimetric characteristics and CIL in paragraph 4.1.5., for an angle of divergence of 20' and an illumination angle  $V = H = 0^\circ$  or if necessary, in the position defined in Annex 4 and paragraph 4.1.4..

The two retro-reflecting devices giving the minimum and maximum values shall then be fully tested as shown in paragraph 4.1.4..

These two samples shall be kept by the laboratories for any further checks which may be found necessary.

The other eight samples shall be divided into four groups of two:

First group: The two samples shall be subjected successively to the water penetration test (Annex 7, paragraph 1.1.) and then, if this test is satisfactory, to the tests for resistance to fuels and lubricants (Annex 9, paragraph 1.1.. and Annex 10).

Second group: The two samples shall, if necessary, be subjected to the corrosion test in Annex 11, and then to the abrasive-strength test of the rear face of the retro-reflecting device Annex 12.

Third group: The two samples shall be subjected to the test for stability in time of the optical properties of retro-reflecting device Annex 14.

Fourth group: The two samples shall be subjected to the colour-fastness test (Annex 21).

4.1.3.2. After undergoing the tests referred to in the paragraph 4.1.3.1., the retro-reflecting devices in each group must have:

4.1.3.2.1. a colour which satisfies the conditions laid down in paragraph 4.1.5..

- 4.1.3.2.2. a CIL which satisfies the conditions laid down in paragraph 4.1.4. The verification shall be performed only for an angle of divergence of 20' and an illumination angle of  $V = H = 0^\circ$  or, if necessary, in all positions specified in paragraph 4.1.4.
- 4.1.4. Minimum values for the CIL values of retro-reflection
- 4.1.4.1. When applying for approval, the applicant shall specify one or more or a range of axis of reference, corresponding to the illumination angle  $V = H = 0^\circ$  in the table of coefficients of luminous intensity (CIL).
- 4.1.4.2. In the case where more than one or a range of different axis of reference are specified by the manufacturer, the photometric measurements shall be repeated making reference each time to a different axis of reference or to the extreme axis of reference of the range specified by the manufacturer.
- 4.1.4.3. For photometric measurements, only the illuminating surface defined by the planes contiguous to the outermost parts of the optical system of the retro-reflecting device as indicated by the manufacturer and contained within a circle of 200 mm diameter for Class IA or IB shall be considered, and the illuminating surface itself shall be limited to 100 cm<sup>2</sup> though the surfaces of the retro-reflecting optical units need not necessarily attain this area. The manufacturer shall specify the perimeter of the area to be used.
- 4.1.4.4. Class IA and Class IB
- 4.1.4.4.1. When measured as described in paragraph 3 and Annex 4, the CIL values for red retro-reflecting devices must be equal to or greater than those in Table 2, expressed in millicandelas per lux, for the angles of divergence and illumination shown.

**Table 2: Requirements for CIL values (Classes IA and IB)**

Class	Angle of divergence $\alpha$	Illumination angles (in degrees)				
		Vertical Horizontal	V H	$0^\circ$ $0^\circ$	$\pm 10^\circ$ $0^\circ$	$\pm 5^\circ$ $\pm 20^\circ$
IA, IB	20'			300	200	100
	1°30'			5	2.8	2.5

CIL values lower than those shown in the last two columns of Table 2 are not permissible within the solid angle having the reference centre as its apex and bounded by the planes intersecting along the following lines:

$$(V = \pm 10^\circ, H = 0^\circ) \quad (V = \pm 5^\circ, H = \pm 20^\circ).$$

- 4.1.4.4.2. CIL values for amber retro-reflecting devices in Class IA or IB must be at least equal to those in Table 2 multiplied by the coefficient 2.5.
- 4.1.4.4.3. CIL values for colourless retro-reflecting devices in Class IA or IB must be at least equal to those in Table 2 multiplied by the coefficient 4.



4.1.4.5. However, in the case where a retro-reflecting device of Class IA or Class IB, is intended to be installed with its H plane at a mounting height less than 750 mm above the ground, the CIL values are verified only up to an angle of 5° downwards.

4.1.5. Colour of light emitted:

4.1.5.1. The testing of the colour for retro-reflecting device (night-time colour) shall be carried out according to the method described in [paragraph 3.2.2.](#)

4.1.5.2. The trichromatic coordinates of the reflected luminous flux must be within the limits for the night-time colours red, amber or white as specified in UN Regulation 48.

4.1.6. Special specification (tests)

Depending on the nature of the materials of which the retro-reflecting devices and, in particular, their optical units, are made, the competent authorities may authorize laboratories to omit certain unnecessary tests, subject to the express reservation that such omission must be mentioned under "Remarks" on the form notifying approval.

This is only applicable to tests described in [Annexes 11, 12, 14 and 21.](#)



<i>Number of annex</i>	<i>Number of paragraph</i>	<i>Tests</i>	<i>Samples</i>											
			<i>a</i>	<i>b</i>	<i>c</i>	<i>d</i>	<i>e</i>	<i>f</i>	<i>g</i>	<i>h</i>	<i>i</i>	<i>j</i>		
		trichromatic coordinates												
4	3.2.	Photometry: limited to 20' and V = H = 0°												
11	-	Colour-fastness												
4	3.1.	Colorimetry: Visual inspection or trichromatic coordinates												
4	3.2.	Photometry: limited to 20' and V = H = 0°												
4	2.	Deposit of samples with authority			x	x								

\* of the Regulation.

## 4.2 Technical requirements concerning retro-reflectors of the Classes IIIA and IIIB (symbols "IIIA" and "IIIB")

4.2.1. Every retro-reflector of the Classes IIIA and IIIB, when tested according to paragraph 4.2.3., shall meet:

- the dimensions and shape requirements set forth in Annex 5, and
- the photometric and colorimetric requirements as specified in paragraphs 4.2.4. to 4.2.5. and
- the physical and mechanical requirements set forth in paragraph 4.2.6, depending on the nature of the materials and construction of the retro-reflecting devices

4.2.2. The applicant shall submit ten samples for approval which shall be tested in the chronological order as indicated in paragraph 4.2.7. 4.2.3. Test procedure.

4.2.3.1. After verification of the general specifications (paragraph 2.) and the specifications of shape and dimensions (Annex 5), the ten samples shall be subjected to the heat resistance test described in Annex 6 and at least one hour after this test examined as to their colorimetric characteristics and CIL in paragraph 4.2.5., for an angle of divergence of 20' and an illumination angle  $V = H = 0^\circ$  or if necessary, in the position defined in Annex 4 and paragraphs 4.2.4..

The two retro-reflecting devices giving the minimum and maximum values shall then be fully tested as shown in paragraph 4.2.4..

These two samples shall be kept by the laboratories for any further checks which may be found necessary.

The other eight samples shall be divided into four groups of two:

First group: The two samples shall be subjected successively to the water penetration test (Annex 7, paragraph 1.1.) and then, if this test is satisfactory, to the tests for resistance to fuels and lubricants (Annex 9, paragraphs 1.1.. and Annex 10).

Second group: The two samples shall, if necessary, be subjected to the corrosion test in Annex 11, and then to the abrasive-strength test of the rear face of the retro-reflecting device Annex 12.

Third group: The two samples shall be subjected to the test for stability in time of the optical properties of retro-reflecting device Annex 14.

Fourth group: The two samples shall be subjected to the colour-fastness test (Annex 21).

4.2.3.2. After undergoing the tests referred to in the paragraph 4.2.3.1, the retro-reflecting devices in each group must have:

4.2.3.2.1. a colour which satisfies the conditions laid down in paragraph 4.2.5..

4.2.3.2.2. a CIL which satisfies the conditions laid down in paragraph 4.2.4.. The verification shall be performed only for an angle of divergence of 20' and an illumination angle of  $V = H = 0^\circ$  or, if necessary, in all positions specified in paragraphs 4.2.4.

4.2.4. Minimum values for the CIL values of retro-reflection:

4.2.4.1. When measured as described in paragraph 3 and Annex 4, the CIL values for red retro-reflecting devices must be equal to or greater than those in Table 4, expressed in millicandelas per lux, for the angles of divergence and illumination shown.

Table 4: Requirements for CIL values (Classes IIIA and IIIB)

Class	Angle of divergence $\alpha$	Illumination angles (in degrees)				
		Vertical Horizontal	V H	0° 0°	$\pm 10^\circ$ 0°	$\pm 5^\circ$ $\pm 20^\circ$
IIIA, IIIB	20'			450	200	150
	1°30'			12	8	8

CIL values lower than those shown in the last two columns of Table 4 are not permissible within the solid angle having the reference centre as its apex and bounded by the planes intersecting along the following lines:

$$V = \pm 10^\circ, H = 0^\circ \quad (V = \pm 5^\circ, H = \pm 20^\circ).$$

4.2.4.2. However, in the case where a retro-reflecting device of Class IIIA or Class IIIB is intended to be installed with its H plane at a mounting height less than 750 mm above the ground, the CIL values are verified only up to an angle of 5° downwards.

4.2.5. Colour of light emitted:

4.2.5.1. The testing of the colour for retro-reflecting device (night-time colour) shall be carried out according to the method described in paragraph 3.2.2..

4.2.5.2. The trichromatic coordinates of the reflected luminous flux must be within the limits for the night-time colour red as specified in UN Regulation 48.

4.2.6. Special specification (tests)

Depending on the nature of the materials of which the retro-reflecting devices and, in particular, their optical units, are made, the competent authorities may authorize laboratories to omit certain unnecessary tests, subject to the express reservation that such omission must be mentioned under "Remarks" on the form notifying approval.

This is only applicable to tests described in Annexes 11, 12, 14 and 21.

4.2.7. Chronological order of tests

**Table 5:** Chronological order of tests (Classes IIIA and IIIB)

Number of annex	Number of paragraph	Tests	Samples											
			a	b	c	d	e	f	g	h	i	j		
-	6.*	General specifications: visual inspection	x	x	x	x	x	x	x	x	x	x	x	x
5	-	Shapes and dimensions: visual inspection	x	x	x	x	x	x	x	x	x	x	x	x
10	-	Heat: 48 h at 65° ± 2°C	x	x	x	x	x	x	x	x	x	x	x	x
		Visual inspection for distortion	x	x	x	x	x	x	x	x	x	x	x	x
6	-	Colorimetry: visual inspection	x	x	x	x	x	x	x	x	x	x	x	x
		Trichromatic coordinates in case of doubt		x										
7	-	Photometry: limited to 20' and V = H = 0°	x	x	x	x	x	x	x	x	x	x	x	x
7	3.	Complete photometry			x	x								
8	1.	Water: 10 min. in normal position								x	x			
		10 min. in inverted position								x	x			
		visual inspection								x	x			
4	3.1.	Colorimetry: visual inspection								x	x			
		Trichromatic coordinates in case of doubt								x	x			
4	3.2.	Photometry: limited to 20' and V = H = 0°								x	x			
8	3.	Motor fuels: 5 min.								x	x			
		visual inspection								x	x			
8	4.	Oils: 5 min.								x	x			
		visual inspection								x	x			
4	3.1.	Colorimetry: visual inspection												
		Trichromatic coordinates in case of doubt								x	x			
4	3.2.	Photometry: limited to 20' and V = H = 0°								x	x			
8	2.	Corrosion: 24 hours						x	x					
		2 hours interval						x	x					
		24 hours						x	x					
		visual inspection						x	x					
8	5.	Rear face: 1 min.						x	x					
		visual inspection						x	x					
4	3.1.	Colorimetry: visual inspection						x	x					
		Trichromatic coordinates in case of doubt						x	x					
4	3.2.	Photometry: limited to 20' and V = H = 0°						x	x					
9	-	Stability in time												
4	3.1.	Colorimetry: Visual inspection or trichromatic coordinates												
4	3.2.	Photometry: limited to 20' and V = H = 0°												
11	-	Colour-fastness												
4	3.1.	Colorimetry: Visual inspection or trichromatic coordinates												
4	3.2.	Photometry: limited to 20' and V = H = 0°												
4	2.	Deposit of samples with authority			x	x								

\* of the Regulation.

### 4.3 Technical requirements concerning retro-reflectors of the Class IVA (symbols “IVA”)

4.3.1. Every retro-reflector of the Class IVA, when tested according to paragraph 4.3.3., shall meet:

- the dimensions and shape requirements set forth in Annex 5, and
- the photometric and colorimetric requirements as specified in paragraphs 4.3.4. to 4.3.5. and
- the physical and mechanical requirements set forth in paragraph 4.3.6, depending on the nature of the materials and construction of the retro-reflecting devices

4.3.2. The applicant shall submit ten samples for approval which shall be tested in the chronological order as indicated in paragraph 4.3.7. 4.3.3.

4.3.3. Test procedure

4.3.3.1. After verification of the specifications in paragraphs 3.1. and the specifications of shape and dimensions in Annex 5, the ten samples shall be subjected to the heat resistance test in Annex 6 and one hour minimum after this test examined as to their colorimetric characteristics and CIL in paragraph 4.3.4. for an angle of divergence of 20' and an illumination angle  $V = H = 0^\circ$  or, if necessary, in the positions defined in Annex 7. The two retro-reflecting devices giving the minimum and maximum values shall then be fully tested as shown in paragraph 4.3.4.. These two samples shall be kept by the laboratories for any further checks which may be found necessary.

4.3.3.2. Four samples out of the remaining eight samples shall be selected at random and divided into two groups of two in each group.

First group:

The two samples shall be subjected successively to the water-penetration resistance test in Annex 7, paragraph 1. and then, if this test is satisfactory, to the tests for resistance to fuels and lubricating oils in Annex 9, and Annex 10.

Second group:

The two samples shall, if relevant, be subjected to the corrosion test (Annex 11, paragraph 1.), and then to the abrasive-strength test of the rear face of the retro-reflecting device in Annex 12, these two samples shall also be subjected to the impact test in Annex 18).

4.3.3.3. After undergoing the tests referred to in the above paragraph, the retro-reflecting devices in each group must have:

4.3.3.3.1. A colour which satisfies the conditions laid down in paragraph 4.3.5.. This shall be verified by a qualitative method and, in case of doubt, confirmed by a quantitative method;

4.3.3.3.2. A CIL which satisfies the conditions laid down in paragraph 4.3.4..

Verification shall be performed only for an angle of divergence of 20' and an illumination angle of  $V = H = 0^\circ$  or, if necessary, in the positions specified in paragraph 4.3.4..

4.3.3.4. The four remaining samples can be utilized, if necessary, for any other purpose.

Every Retro-reflectors of the Classes IVA shall meet the requirements of the checks and tests described in paragraph 4.3.4...

4.3.4. Minimum values for the CIL values of retro-reflection

4.3.4.1. When measured as described in paragraph 3, for devices of Class IVA the CIL values must be equal to or greater than those in Table 6, expressed in millicandelas per lux, for the angles of divergence and illumination shown.

**Table 6: Requirements for CIL values (Class IVA)**

Colour	Angle of divergence $\alpha$	Illumination angles (in degrees)						
		Vertical V	0	$\pm 10$	0	0	0	0
		Horizontal H	0	0	$\pm 20$	$\pm 30$	$\pm 40$	$\pm 50$
White	20'		1,800	1,200	610	540	470	400
	1°30'		34	24	15	15	15	15
Amber	20'		1,125	750	380	335	290	250
	1°30'		21	15	10	10	10	10
Red	20'		450	300	150	135	115	100
	1°30'		9	6	4	4	4	4

4.3.4.1. However, in the case where a retro-reflecting device of Class IVA is intended to be installed with its H plane at a mounting height less than 750 mm above the ground, the CIL values are verified only up to an angle of 5° downwards.

4.3.5. Colour of light emitted

4.3.5.1. The testing of the colour for retro-reflecting device (night-time colour) shall be carried out according to the method described in paragraph 3.2.2..

4.3.5.2. The trichromatic coordinates of the reflected luminous flux must be within the limits for the night-time colours red, amber or white as specified in UN Regulation 48.

4.3.6. Special specification (tests)

Depending on the nature of the materials of which the retro-reflecting devices and, in particular, their optical units, are made, the competent authorities may authorize laboratories to omit certain unnecessary tests, subject to the express reservation that such omission must be mentioned under "Remarks" on the form notifying approval.

This is only applicable to tests described in Annexes 11, 12, 14 and 21.



4.3.7. Chronological order of tests for Class IVA

**Table 7:** Chronological order of tests (Class IVA)

Number of annex	Number of paragraph	Tests	Samples											
			a	b	c	d	e	f	g	h	i	j		
-	6.*	General specifications: visual inspection	x	x	x	x	x	x	x	x	x	x	x	x
5	-	Shape and dimensions: visual inspection	x	x	x	x	x	x	x	x	x	x	x	x
10	-	Heat: 48 h at 65 °C ± 2°C Visual inspection for distortion	x	x	x	x	x	x	x	x	x	x	x	x
6	-	Colorimetry: visual inspection Trichromatic coordinates in case of doubt	x	x	x	x	x	x	x	x	x	x	x	x
7	-	Photometry: limited to 20' and V = H = 0°	x	x	x	x	x	x	x	x	x	x	x	x
7	-	Complete photometry	x	x										
8	1.	Water: 10 min. in normal position 10 min. in inverted position visual inspection			x	x								
8	3.	Motor fuels: 5 min. visual inspection			x	x								
8	4.	Oils: 5 min. visual inspection			x	x								
6	-	Colorimetry: visual inspection Trichromatic coordinates in case of doubt			x	x								
7	-	Photometry: limited to 20' and V = H = 0°			x	x								
8	2.	Corrosion: 24 hours 2 hours' interval 24 hours visual inspection					x	x						
8	5.	Rear face: 1 min. visual inspection					x	x						
13	-	Impact visual inspection					x	x						
6	-	Colorimetry: visual inspection Trichromatic coordinates in case of doubt					x	x						
7	-	Photometry: limited to 20' and V = H = 0°					x	x						
14	2.	Deposit of samples with Authority	x	x										

\* of the Regulation.

## 4.4 Technical requirements concerning retro-reflective markings of the Class C (symbol “C”)

- 4.4.1. Every retro-reflective marking of the Class C, when tested according to paragraph 4.4.3., shall meet:
- the dimensions and shape requirements set forth in Annex 5, and
  - the photometric and colorimetric requirements as specified in paragraphs 4.4.4. to 4.4.5. and
  - the physical and mechanical requirements set forth in paragraph 4.4.6.
- 4.4.2. The applicant shall submit for approval:
- 4.4.2.1. Five test samples representing strips of retro-reflective marking materials have to be submitted to the test laboratory. In the case of strips, at least a length of 3 meters shall be provided
- 4.4.2.2. The test samples shall be representative of current production, manufactured in accordance with the recommendation of the manufacturer(s) of the retro-reflective marking materials.<sup>1/</sup>
- 4.4.2.3. The samples shall be tested in the chronological order indicated in Paragraph 4.4.7..
- 4.4.3. Test procedure
- 4.4.3.1. After verification of the general specifications (paragraph 3) and the specifications of shape and dimensions (Annex 5), the samples shall be subjected to the heat resistance test described in Annex 6, prior to the tests described in the Paragraphs 4.4.4. and 4.4.5.
- 4.4.3.2. The photometric and colorimetric measurements may be made on five samples. The mean values should be taken.
- 4.4.3.3. For other tests, samples which have not undergone any testing should be used.
- 4.4.4. Minimum values for the coefficient of retro-reflection  
Photometric specifications for retro-reflective markings of Class C:
- 4.4.4.1. When measured as described in paragraph 3 and Annex 4, the coefficient of retro-reflection R' in candelas per m<sup>2</sup> per lux (cd/m<sup>2</sup>/lux) of the retro-reflective areas in new condition shall be at least as indicated in Table 8 for white, yellow and red materials."

---

<sup>1/</sup> Test samples of retro-reflective marking materials shall be applied to edged and degreased aluminum panels of 2 mm thickness and shall be conditioned for 24 hours at 23°C ± 2°C at 50% ± 5% relative humidity prior to testing.

"Table 8 : Minimum values for the Coefficient of Retro-reflection R' [cd.m<sup>-2</sup>.lx<sup>-1</sup>]

Observation angle $\alpha$ [°]	Entrance Angle $\beta$ [°]					
	$\beta 1$	0	0	0	0	0
$\alpha=0.33(20')$	$\beta 2$	5	20	30	40	60
Colour						
Yellow		300	--	130	75	10
White		450	--	200	95	16
Red		120	60	30	10	--

4.4.5. Colour of light emitted

- 4.4.5.1. The testing of the colour for retro-reflecting device (night-time colour) shall be carried out according to the method described in paragraph 3.2.2..
- 4.4.5.2. The trichromatic coordinates of the reflected luminous flux must be within the limits for the night-time colours red, amber or white as specified in UN Regulation 48..

4.4.6. Resistance to external agents

4.4.6.1. Resistance to weathering

Procedure - For each test, two specimens of a sample unit (see paragraph 4.4.2.) are taken. One specimen shall be stored in a dark and dry container for subsequent use as "reference unexposed specimen".

The second specimen shall be subjected to a test as specified in Annex 13.

4.4.6.2. Resistance to corrosion

A specimen of the sample unit shall be subjected to a test as specified in Annex 11.

4.4.6.3. Resistance to fuels

A specimen of the sample unit shall be subjected to a test as specified in Annex 9.

4.4.6.4. Resistance to heat

A specimen of the sample unit shall be subjected to a test as specified in paragraph ... in Annex 6 .

4.4.6.5. Resistance to cleaning

A specimen of the sample unit shall be subjected to a test as specified in paragraph ... in Annex 15 .

4.4.6.6. Stability of photometric properties

A specimen of the sample unit shall be subjected to a test as specified in paragraph ... in Annex 14 .

4.4.6.7. Resistance to penetration of water

A specimen of the sample unit shall be subjected to a test as specified in paragraph ... in Annex 7.

4.4.6.8. Bonding strength (in the case of adhesive materials)

A specimen of the sample unit shall be subjected to a test as specified in paragraph ... in Annex 16 .

4.4.6.9. Flexing

For samples that are to be adhered to a flexible substrate, i.e. tarpaulin, the following shall apply:

A specimen of the sample unit shall be subjected to a test as specified in paragraph ... in Annex 17 .

4.4.7. Chronological order of tests for Class C

4.4.7.1. Five test samples representing either strips or planes of retro-reflective marking materials have to be submitted to the test laboratory. In the case of strips, at least a length of 3 meters shall be provided; in the case of planes, at least a surface of 500 mm x 500 mm shall be provided.

4.4.7.2. The test samples shall be representative of current production, manufactured in accordance with the recommendation of the manufacturer(s) of the retro-reflective marking materials.<sup>1/</sup>

4.4.7.3. After verification of the general specifications (paragraph 6) and the specifications of shape and dimensions (Annex 5), the samples shall be subjected to the heat resistance test described in Annex 8, prior to the tests described in Annexes 6 and 7.

4.4.7.4. The photometric and colorimetric measurements may be made on five samples. The mean values should be taken.

4.4.7.5. For other tests, samples which have not undergone any testing should be used.

---

<sup>1/</sup> Test samples of retro-reflective marking materials shall be applied to edged and degreased aluminum panels of 2 mm thickness and shall be conditioned for 24 hours at 23°C ± 2°C at 50% ± 5% relative humidity prior to testing.

## 4.5 Technical requirements concerning Retroreflective Markings of the Classes D and E (symbols “D” and “E”)

4.5.1. Every retro-reflective marking of the Classes D and E shall meet the photometric requirements as specified in paragraphs 4.5.4. to 4.5.5.

4.5.2. The applicant shall submit for approval:

4.5.2.1. Five test samples representing planes of retro-reflective marking materials have to be submitted to the test laboratory. In the case of planes, at least a surface of 500 mm x 500 mm shall be provided.

4.5.2.2. The test samples shall be representative of current production, manufactured in accordance with the recommendation of the manufacturer(s) of the retro-reflective marking materials.<sup>1/</sup>

4.5.3. Test procedure

Every retro-reflective marking of the Class D and E shall meet the requirements of the checks and tests described in Paragraph 4.5.3. to 4.5.6.

4.5.4. Maximum values for the coefficient of retro-reflection

Photometric specifications for distinctive markings or graphics of class D and class E:

Table 9: Maximum values for the Coefficient of Retro-reflection R' [cd.m<sup>-2</sup>.lx<sup>-1</sup>]

Observation angle $\alpha$ [°]		Entrance Angle $\beta$ (°)				
$\alpha = 0,33^\circ (20')$		$\beta_1$	0	0	0	0
		$\beta_2$	5	30	40	60
Any colour	class D		150	65	37	5
	class E		50	22	12	1

**Note:** If the sample is provided with an orientation mark, the specified values must only be observed for this orientation. Test samples without an orientation mark must be observed for values at 0° and 90° orientations as well.

4.5.5. Colour of light emitted

4.5.5.1. Retro-reflective distinctive markings and/or graphics (classes D and E) may be of any colour.

4.5.6. Special specification (tests)

<sup>1/</sup> Test samples of retro-reflective marking materials shall be applied to edged and degreased aluminum panels of 2 mm thickness and shall be conditioned for 24 hours at 23°C ± 2°C at 50% ± 5% relative humidity prior to testing.

- 4.5.6.1. Advertising, consisting of retro-reflective logos, distinctive markings or letters/characters has to be decent.

It may consist of marking materials of class "D" if the total retro-reflective area is less than 2 m<sup>2</sup>; if the total retro-reflective area is at least 2 m<sup>2</sup> class "E" shall be used. <sup>1/</sup>

- 4.5.6.2. White retro-reflective marking materials intended as base or background in printing processes for fully coloured logos and markings of class "E" in use, without unprinted blank areas, may fulfil the requirements in Annex 7, table 2, for class "D" materials and must be marked as class "D/E".

- 4.5.6.3. Depending on the nature of retro-reflective marking material, the competent authorities may authorize laboratories to omit certain unnecessary tests, provided that such omission is mentioned under "Remarks" on the form notifying approval.

---

<sup>1/</sup> Nothing in this Regulation shall preclude the national authorities to prohibit the use of retro-reflective advertising, logos, distinctive markings, letters/characters as defined in paragraph 2.1.2. of this Regulation.

## 4.6 Technical requirements concerning retro-reflective markings of the Class F and retro-reflective marking plates of the Class 5

- 4.6.1. Every retro-reflective marking of the Class F shall meet the requirements of the checks and tests for:
- dimensions and shape set forth in Annex 5, and
  - the photometric and colorimetric requirements as specified in paragraph 4.6.4. to 4.6.6. and
  - the physical and mechanical requirements set forth in paragraph 4.4.6.
- 4.6.2. The applicant shall submit for approval:
- 4.6.2.1. Five test samples representing either strips or planes of retro-reflective marking materials to the test laboratory. In the case of strips, at least a length of 3 meters shall be provided; in the case of planes, at least a surface of 500 mm x 500 mm shall be provided.
- 4.4.2.2. The test samples shall be representative of current production, manufactured in accordance with the recommendation of the manufacturer(s) of the retro-reflective marking materials.<sup>1/</sup>

The samples shall be tested in the chronological order indicated in Paragraph 4.3.5..

### 4.6.3. Test procedure

Every retro-reflective marking of the Class F and Class 5 shall meet the requirements of the checks and tests described in Paragraphs 4.6.4. and 4.6.6.

- 4.6.4. Minimum values for the Coefficient of Retro-reflection  
Photometric specifications for retro-reflective markings of Class F:

Table 10: Minimum values for the Coefficient of Retro-reflection R' [cd.m<sup>-2</sup>.lx<sup>-1</sup>]

Observation angle $\alpha$ [°]	Entrance Angle $\beta$ [°]					
	$\beta 1$	0	0	0	0	0
$\alpha=0.33(20')$	$\beta 2$	5	20	30	40	60
Colour						
White		450	--	200	95	16
Red		120	60	30	10	--

<sup>1/</sup> Test samples of retro-reflective marking materials shall be applied to edged and degreased aluminum panels of 2 mm thickness and shall be conditioned for 24 hours at 23°C ± 2°C at 50% ± 5% relative humidity prior to testing.

4.6.5. Colour of light emitted

4.6.5.1. The testing of the colour for retro-reflecting device (day-time colour) shall be carried out according to the method described in paragraph 3.2.3..

4.6.5.2. The trichromatic coordinates of the reflected luminous flux must be within the limits for the colour:

- red as specified in paragraph 2.31.3.
- white as specified in paragraph 2.31.1.

of UN Regulation 48

4.6.5.3. Luminance factor determined in accordance to paragraph 3.3:

- for red colour shall be  $\geq 0.03$ .
- for white colour, it shall be  $\geq 0.25$ .

4.6.6. Resistance to external agents

4.6.6.1. Resistance to weathering

Procedure - For each test, two specimens of a sample unit (see paragraph 2.1.4.) are taken. One specimen shall be stored in a dark and dry container for subsequent use as "reference unexposed specimen".

The second specimen shall be subjected to a test as specified in Annex 13

4.6.6.2. Resistance to corrosion

A specimen of the sample unit shall be subjected to a test as specified in Annex 11.

4.6.6.3. Resistance to fuels

A specimen of the sample unit shall be subjected to a test as specified in Annex 9.

4.6.6.4. Resistance to heat

A specimen of the sample unit shall be subjected to a test as specified in paragraph ... in Annex 6 .

4.6.6.5. Resistance to cleaning

A specimen of the sample unit shall be subjected to a test as specified in paragraph ... in Annex 15 .

4.6.7. Stability of photometric properties

A specimen of the sample unit shall be subjected to a test as specified in paragraph ... in Annex 14 .

4.6.8. Resistance to penetration of water

A specimen of the sample unit shall be subjected to a test as specified in paragraph ... in Annex 7.



4.6.9. Bonding strength (in the case of adhesive materials)

A specimen of the sample unit shall be subjected to a test as specified in paragraph ... in Annex 16 .

4.6.10. Flexing

For samples that are to be adhered to a flexible substrate, i.e. tarpaulin, the following shall apply:

A specimen of the sample unit shall be subjected to a test as specified in paragraph ... in Annex 17 .

4.6.11. In the case of Plates:

A specimen of a complete plate shall be subjected to a test of rigidity of plates as specified in in Annex 19

## 4.7 Technical requirements concerning Retroreflective Markings Plates of the Classes 1, 2, 3 and 4

4.7.1. **Retro-reflecting devices of this paragraph must satisfy the conditions as to**

- dimensions and shape set forth in Annexes 5, and
- the photometric and colorimetric as specified in paragraph 4.7.4. to 4.7.5. and
- the physical and mechanical requirements set forth in paragraph 4.4.6.

4.7.2. **The applicant shall submit for approval:**

4.7.2.1. Two large chevron rear marking plates for trucks and tractors and two large rear marking plates for trailers and semi-trailers (or their equivalent in smaller plates) shall be supplied to the testing laboratory for the various tests to be conducted.

4.7.2.2. The test samples shall be representative of current production, fabricated in accordance with the recommendations of the manufacturer of the retro-reflective or retro-reflective/fluorescent materials or devices.

The samples shall be tested in the chronological order indicated in Paragraph 4.3.3. below.

4.7.3. Test procedure

Every retroreflective marking Plate of the classes 1, 2, 3 and 4: shall meet the requirements of the checks and tests described in Annex 5.

4.7.3.1. After verification of the general specifications (paragraph 6) and the specifications of shape and dimensions (Annex 5) the samples shall be subjected to the heat resistance test described in Annex 9 to this Regulation, prior to the tests described in Annexes 6, 7 and 8.

4.7.3.2. The photometric and colorimetric measurements may be made on the same sample.

4.7.3.3. For the other tests, samples which have not undergone any testing should be used.

4.7.4. Maximum values for the coefficient of retro-reflection

Ph

otometric specifications for retroreflective markings plates of the classes 1, 2, 3 and 4:

Devices of class 1 and class 2 shall fulfil the values in table 1 for yellow only, devices of class 3 and class 4 those in table 1 for yellow and red.

Table 11: Minimum values for the Coefficient of Retro-reflection R' [cd.m<sup>-2</sup>.lx<sup>-1</sup>]

Observation angle $\alpha$ [']	Entrance angle $\beta$ [°]				
	$\beta_1$	0°	0°	0°	0°
20'	$\beta_2$	5°	30°	40°	60°
	Colour: Yellow	300	180	75	10
Coefficient R' [cd.m <sup>-2</sup> .lx <sup>-1</sup> ]	Red	10	7	4	-

4.7.4..2. The subtended angle at the sample shall not be larger than 80'.

4.7.5. Colour of light emitted

4.7.5.1. The testing of the colour for retro-reflecting device (night-time colour) shall be carried out according to the method described in paragraph 3.2.2..

4.7.5.1.1. The trichromatic coordinates of the reflected luminous flux must be within the limits for the colour:

- red as specified in paragraph 2.29.4.

- amber as specified in paragraph 2.29.3.

of Regulation 48

4.7.5.2.. The testing of the colour for retro-reflecting device (day-time colour) shall be carried out according to the method described in paragraph 3.2.3..

4.7.5.2.1.. The trichromatic coordinates of the reflected luminous flux must be within the limits for the colour:

- red as specified in paragraph 2.31.3.

- yellow as specified in paragraph 2.31.2.

of Regulation 48

4.7.5.2.2. Luminance factor  $\beta$  determined in accordance to paragraph 3.3. to this Regulation:

- for red colour shall be  $\geq 0.03$ .

- For yellow colour, it shall be  $\geq 0.16$ .

4.7.5.3.. The testing of the colour for the fluorescent material shall be carried out according to the method described in paragraph 3.2.4..

4.7.5.3.1. The trichromatic coordinates of the reflected luminous flux must be within the limits for the colour as specified in paragraph 2.32.1. of Regulation 48

4.7.5.3.2. Luminance factor  $\beta$  determined in accordance to paragraph 3.3.:

- for red colour shall be  $\geq 0.3$ .

## COLORIMETRIC SPECIFICATIONS

- 4.7.4.1. Rear marking plates for heavy vehicles and trailers shall be composed of yellow retro-reflective and red retro-reflective or yellow retro-reflective and red fluorescent materials or devices.

### 4.7.6. Special specification (tests)

#### RESISTANCE TO EXTERNAL AGENTS

##### 4.4.6.1. Resistance to weathering

- 4.4.6.1.1. Procedure - For each test, two specimens of a sample unit (see paragraph 2.1.4.) are taken. One specimen shall be stored in a dark and dry container for subsequent use as "reference unexposed specimen".

The second specimen shall be subjected to a test as specified in Annex 13

##### 4.4.6.2. Resistance to corrosion

- 2.1. A specimen of the sample unit shall be subjected to a test as specified in Annex 11.

##### 4.4.6.3. Resistance to fuels

A specimen of the sample unit shall be subjected to a test as specified in Annex 9.

##### 4.4.6.4. Resistance to heat

A specimen of the sample unit shall be subjected to a test as specified in paragraph ... in Annex 6 .

##### 4.4.6.5. Resistance to cleaning

A specimen of the sample unit shall be subjected to a test as specified in paragraph ... in Annex 15 .

##### 4.4.6.6. Stability of photometric properties

A specimen of the sample unit shall be subjected to a test as specified in paragraph ... in Annex 14 .

##### 4.4.6.7. Resistance to penetration of water

A specimen of the sample unit shall be subjected to a test as specified in paragraph ... in Annex 7.

4.4.6.8. Bonding strength (in the case of adhesive materials)

A specimen of the sample unit shall be subjected to a test as specified in paragraph ... in Annex 16 .

4.4.6.9. Flexing

4.4.6.9.1. For samples that are to be adhered to a flexible substrate, i.e. tarpaulin, the following shall apply:

A specimen of the sample unit shall be subjected to a test as specified in paragraph ... in Annex 17 .

4.4.6.9.2. **In the case of Plates:**

A specimen of a complete plate shall be subjected to a test of rigidity of plates as specified in in Annex 19

## 4.7.7. Chronological order of tests for Classes 1,2,3 and 4

4.7.7.1. Two large chevron rear marking plates for trucks and tractors and two large rear marking plates for trailers and semi-trailers (or their equivalent in smaller plates) shall be supplied to the testing laboratory for the various tests to be conducted.

4.7.7.2. The test samples shall be representative of current production, fabricated in accordance with the recommendations of the manufacturer of the retro-reflective or retro-reflective/fluorescent materials or devices.

4.7.7.3. After verification of the general specifications (paragraph 6. of the Regulation) and the specifications of shape and dimensions (Annex 5) the samples shall be subjected to the heat resistance test described in Annex 9 to this Regulation, prior to the tests described in Annexes 6, 7 and 8.

4.7.7.4. The photometric and colorimetric measurements may be made on the same sample.

4.7.7.5. For the other tests, samples which have not undergone any testing should be used.

## **4.8 Technical requirements concerning retroreflective marking plates for slow moving vehicles of the Class SMV**

### **4.8.1. Retro-reflecting devices of this paragraph must satisfy the conditions as to**

- dimensions and shape set forth in paragraph ...in Annexes 8, and
- the photometric and colorimetric as specified in paragraph 4.2.4. to 4.2.6. and
- the physical and mechanical requirements set forth in Annexes 9, 11 to 13.

### **4.8.2. The applicant shall submit for approval:**

4.8.2.1. Five SMV rear marking plates shall be supplied to the testing laboratory for the various tests to be conducted.

4.8.2.2. The test samples shall be representative of current production, fabricated in accordance with the recommendations of the manufacturer(s) of the retro-reflective and fluorescent (class 1) or retro-reflective only (class 2).

**The samples shall be tested in the chronological order indicated in Paragraph 4.3.5. below.**

### **4.8.3. Test procedure**

Every Retroreflective Markings Plates for slow moving vehicles of the Class SMV shall meet the requirements of the checks and tests described in Annex 5.

4.8.3.1. After verification of the general specifications (paragraph 6) and the specifications of shape and dimensions (Annex 5) four samples shall be subjected to the heat resistance test described in Annex 9 to this Regulation, prior to the tests described in Annexes 6, 7 and 8. The fifth sample shall be kept for reference purposes during the test procedures.

4.8.3.2. The photometric and colorimetric measurements may be made on the same sample.

4.8.3.3. For the other tests, samples which have not undergone any testing should be used.

### **4.8.4. Maximum values for the coefficient of retro-reflection**

Photometric specifications for retroreflective markings plates for slow moving vehicles of the Class SMV

4.8.4.1. When measured as described in paragraph 3, the coefficient of retro-reflection R' in candelas per m<sup>2</sup> per lux (cd/m<sup>2</sup>/lux) of the entire red retro-reflective area in new condition shall be at least as indicated in table 1.

Table 12: Minimum values for the Coefficient of Retro-reflection R' [cd.m<sup>-2</sup>.lx<sup>-1</sup>]

Observation angle $\alpha$ [°]	Entrance angle $\beta$ [°]				
	$\beta_1$	0°	0°	0°	0°
20'	$\beta_2$	5°	20°	30°	40°
Coefficient R' [cd.m <sup>-2</sup> .lx <sup>-1</sup> ]	R' of the outer border (class 1, 2)	120	60	30	10
	R' of the enclosed triangle (class 2)	10	7	4	-

4.7.4..2. The subtended angle at the sample shall not be larger than 80'.

4.8.4.2. The subtended angle at the sample shall not be larger than 80'.

4.8.5. Colour of light emitted

4.8.5.1.. The testing of the colour for retro-reflecting device (night-time colour) shall be carried out according to the method described in paragraph 3.2.2..

4.8.5.1.1. The trichromatic coordinates of the reflected luminous flux must be within the limits for the colour as specified in paragraph 2.29.4. of Regulation 48.

4.8.5.2.. The testing of the colour for retro-reflecting device (day-time colour) shall be carried out according to the method described in paragraph 3.2.3. to this Regulation.

4.8.5.2. The trichromatic coordinates of the reflected luminous flux must be within the limits for the colour red as specified in paragraph 2.31.3. of Regulation 48.

4.8.5.3. Luminance factor  $\beta$  determined in accordance to paragraph 3.3. to this Regulation shall be  $\geq 0.03$ .

4.8.5.3.. The testing of the colour for the fluorescent material shall be carried out according to the method described in paragraph 3.2.4..

4.8.5.3.1. The trichromatic coordinates of the reflected luminous flux must be within the limits for the colour as specified in paragraph 2.32.1. of Regulation 48

4.8.5.3.2. Luminance factor  $\beta$  determined in accordance to paragraph 3.3.:

- for red colour shall be  $\geq 0.3$ .

4.8.3. COLORIMETRIC SPECIFICATIONS

4.8.3.1. SMV rear marking plates for slow-moving vehicles and their trailers shall be composed either of red retro-reflective and red fluorescent materials or devices (class 1) or red retro-reflective only materials or devices (class 2).

4.8.6. Special specification (tests)

RESISTANCE TO EXTERNAL AGENTS

4.8.6.1. Resistance to weathering

4.8.6.1.1. Procedure - For each test, two specimens of a sample unit (see paragraph 2.1.4. of this Regulation) are taken. One specimen shall be stored in a dark and dry container for subsequent use as "reference unexposed specimen".

The second specimen shall be subjected to a test as specified in Annex 13

4.8.6.2. Resistance to corrosion

4.4.6.2.1. A specimen of the sample unit shall be subjected to a test as specified in Annex 11.

4.8.6.3. Resistance to fuels

A specimen of the sample unit shall be subjected to a test as specified in Annex 9.

4.8.6.4. Resistance to heat

A specimen of the sample unit shall be subjected to a test as specified in paragraph ... in Annex 6 .

4.8.6.5. Resistance to cleaning

A specimen of the sample unit shall be subjected to a test as specified in paragraph ... in Annex 15 .

4.8.6.6. Stability of photometric properties

A specimen of the sample unit shall be subjected to a test as specified in paragraph ... in Annex 14 .

4.8.6.7. Resistance to penetration of water

A specimen of the sample unit shall be subjected to a test as specified in paragraph ... in Annex 7.

4.8.6.8. Bonding strength (in the case of adhesive materials)

A specimen of the sample unit shall be subjected to a test as specified in paragraph ... in Annex 16 .

4.8.6.9. Flexing



4.8.6.9.1. For samples that are to be adhered to a flexible substrate, i.e. tarpaulin, the following shall apply:  
A specimen of the sample unit shall be subjected to a test as specified in paragraph ... in Annex 17 .

4.8.6.9.2. In the case of Plates:

A specimen of a complete plate shall be subjected to a test of Rigidity of plates as specified in in Annex 19

## **4.8.7. Chronological order**

4.8.7.1. Five SMV rear marking plates shall be supplied to the testing laboratory for the various tests to be conducted.

4.8.7.2. The test samples shall be representative of current production, fabricated in accordance with the recommendations of the manufacturer(s) of the retro-reflective and fluorescent (class 1) or retro-reflective only (class 2).

4.8.7.3. After verification of the general specifications (paragraph 6) and the specifications of shape and dimensions (Annex 5) four samples shall be subjected to the heat resistance test described in Annex 9 to this Regulation, prior to the tests described in Annexes 6, 7 and 8. The fifth sample shall be kept for reference purposes during the test procedures.

4.8.7.4. The photometric and colorimetric measurements may be made on the same sample.

4.8.7.5. For the other tests, samples which have not undergone any testing should be used.

## 4.9 Technical requirements concerning advance warning triangles of Type 1 and 2 (symbols xxxxxx)

### 4.9.1. Retro-reflecting devices of this paragraph must satisfy the conditions as to

- dimensions and shape set forth in paragraph ...in Annexes 8, and
- the photometric and colorimetric as specified in paragraph 4.2.4. to 4.2.6. and
- the physical and mechanical requirements set forth in Annexes 9, 11 to 13.

### 4.9.2. The applicant shall submit for approval:

- 4.9.2.1. Four samples of the advance warning triangle and at least two protective covers if the advance warning triangles are to be supplied with protective covers;
- 4.9.2.2. Two samples of the fluorescent or fluorescent retro-reflecting material in which a 100 x 100 mm square can be inscribed and which are fully representative of the material applied under the same conditions to the same base material as used for the advance warning triangle;
- 4.9.2.3. In the case of a type of advance-warning triangle differing only by the trade name or mark from a type that has already been approved it shall be sufficient to submit:
- 4.9.2.4.. A declaration by the advance-warning triangle manufacturer that the type submitted is identical (except in the trade name or mark) with and has been produced by the same manufacturer as, the type already approved, the latter being identified by its approval code;
- 4.9.2.5. Two samples bearing the new trade name or mark or equivalent documentation.  
The samples shall be tested in the chronological order indicated in Paragraph 4.9.7. below.
- 4.9.3. Test procedure  
Every advance warning triangle and its protective cover, if any, shall meet the requirements of the checks and tests described in Annex 5.
- 4.9.4. Maximum values for the coefficient of retro-reflection  
Photometric specifications for advance warning triangles of Type 1 and 2
  - 4.9.4.1. When measured as described in paragraph 3, the coefficient of retro-reflection R' in candelas per m<sup>2</sup> per lux (cd/m<sup>2</sup>/lux) of the entire red retro-reflective area in new condition shall be at least as indicated in table 13.

PHOTOMETRIC SPECIFICATIONS

4.9.4.1. Retro-reflecting devices and fluorescent retro-reflecting material.

Table 13: Minimum values for the CIL [ $\text{mcd.lx}^{-1}$ ]

	<i>Illumination angles <math>\beta</math></i>			
	$0^\circ$	$\pm 20^\circ$	$0^\circ$	$0^\circ$
Vertical V ( $\beta_1$ )	$0^\circ$	$\pm 20^\circ$	$0^\circ$	$0^\circ$
Horizontal H ( $\beta_2$ )	$0^\circ$ or $\pm 5^\circ$	$0^\circ$	$\pm 30^\circ$	$\pm 40^\circ$
Angles of divergence 20'	8,000	4,000	1,700	600
Angles of divergence 1°30'	600	200	100	50

4.9.4.1.2. The CIL measured on random slices of 50 mm length of the retro-reflecting device shall lie between extremes having a ratio not in excess of 3. These slices are taken between the perpendiculars to the side of the triangle and passing through the corresponding apexes of the central aperture. This requirement applies to an angle of divergence of 20' and to illumination angles of  $V = 0^\circ$ ,  $H = 0^\circ$  or  $\pm 5^\circ$  and  $V = \pm 20^\circ$ ,  $H = 0^\circ$ .

4.9.4.1.3. Diversity of luminance at angles of illumination of  $V = 0^\circ$ ,  $H = \pm 30^\circ$ , and  $V = 0^\circ$ ,  $H = \pm 40^\circ$  shall be tolerated on condition that the triangular shape remains clearly discernible, for an angle of divergence of 20' and an illumination of approximately 1 lux.

4.9.4.1.4. The measurements referred to above shall be performed by the method described in Annex 5 to this Regulation, paragraph 4

4.9.5. Colorimetric specification

4.9.5.1. Retro-reflecting devices

4.9.5.1.1. Retro-reflecting devices shall be made of material coloured red in the mass.

4.9.5.1.2. The testing of the colour for retro-reflecting device (night-time colour) shall be carried out according to the method described in paragraph 3.2.2., and the trichromatic co-ordinates of the red reflected luminous flux shall be within the following limits:

Table 14: Colour coordinates for retro-reflecting device (night-time colour)

<i>Point</i>	<i>1</i>	<i>2</i>	<i>3</i>	<i>4</i>
<i>x</i>	0.712	0.735	0.589	0.625
<i>y</i>	0.258	0.265	0.376	0.375

4.9.5.2. Fluorescent materials

- 4.9.5.2.1. The fluorescent materials shall either be coloured in the mass or take the form of separate coatings applied to the surface of the triangle.
- 4.9.5.2.2. The testing of the colour of the fluorescent materials (daytime colour) of advance warning triangle of type 1 or type 2 shall be carried out according to the method described in paragraph 3.2.4. and the colour of the material in new condition shall be within an area of which the corner points are determined by the following coordinates as specified in table 15:

Table 15: Colour coordinates of the fluorescent materials (daytime colour)

<i>Point</i>	<i>1</i>	<i>2</i>	<i>3</i>	<i>4</i>
<i>x</i>	0.570	0.506	0.595	0.690
<i>y</i>	0.430	0.404	0.315	0.310

- 4.9.5.2.3. The testing of the luminance factor of the fluorescent materials shall be carried out according to the method described in paragraph 3.3.
- The luminance factor including the luminance by reflection and fluorescence shall be:
- (a) For advance warning triangle of type 1, not less than 30 per cent; and
- (b) For advance warning triangle of type 2, not less than 25 per cent.
- 4.9.5.3. The largest measured trichromatic coordinate *y* value according to paragraph 4.9.5.1.2. (night time colour) shall be smaller or equal to the largest measured trichromatic coordinate *y* value according to paragraph 4.9.5.2.2. (day time colour).

4.9.6. **Special specification (tests)**

RESISTANCE TO EXTERNAL AGENTS

4.9.6.1. Resistance to weathering

- 4.9.6.1.1. Procedure - For each test, two specimens of a sample unit (see paragraph 2.1.4.) are taken. One specimen shall be stored in a dark and dry container for subsequent use as "reference unexposed specimen".

The second specimen shall be subjected to a test as specified in Annex 13

4.9.6.2. Resistance to corrosion

- 4.9.6.2.1. A specimen of the sample unit shall be subjected to a test as specified in Annex 11.

4.9.6.3. Resistance to fuels

A specimen of the sample unit shall be subjected to a test as specified in Annex 9.

4.9.6.4. Resistance to heat

A specimen of the sample unit shall be subjected to a test as specified in paragraph ... in Annex 6 .

4.9.6.5. Resistance to cleaning

A specimen of the sample unit shall be subjected to a test as specified in paragraph ... in Annex 15 .

4.9.6.6. Stability of photometric properties

A specimen of the sample unit shall be subjected to a test as specified in paragraph ... in Annex 14 .

4.9.6.7. Resistance to penetration of water

A specimen of the sample unit shall be subjected to a test as specified in paragraph ... in Annex 7.

4.9.6.8. Bonding strength (in the case of adhesive materials)

A specimen of the sample unit shall be subjected to a test as specified in paragraph ... in Annex 16 .

4.9.6.9. Flexing

- 4.9.6.9.1. For samples that are to be adhered to a flexible substrate, i.e. tarpaulin, the following shall apply:  
A specimen of the sample unit shall be subjected to a test as specified in paragraph ... in Annex 17 .

4.9.6.9.2. **Wind test**

A specimen of a complete plate shall be subjected to a test of Rigidity of plates as specified in in Annex xx

**4.9.3. Chronological order**

4.9.3.1. General

- 4.9.3.1.1. The applicant shall submit samples, as mentioned in paragraphs 3.4. and 3.5. of this Regulation, for approval.
- 4.9.3.1.2. After verification of the general specifications (paragraph 6.) and the specifications of shape and dimensions (paragraph 7.1.), all samples shall be subjected to the heat resistance test (paragraph 7.) and examined after at least one hour of rest.
- 4.9.3.1.3. The CIL value of the four samples of the advance warning triangles submitted is measured at an observation angle of 20' and at an illumination angle with the

components  $V = 0^\circ$ ,  $H = \pm 5^\circ$ ; this test is carried out in accordance with the method described in paragraph 4. below.

- 4.9.3.1.4. The two samples with the smallest and the largest CIL value in the tests according to paragraph 1.3. above shall be subsequently subjected to the following tests:
  - 4.9.3.1.4.1. Measurement of the values of the CIL in respect of the observation and illumination angles referred to in paragraphs 7.3.1.1. and 7.3.1.2. according to the method described in paragraph 4. below.
  - 4.9.3.1.4.2. Testing of the colour of the retro-reflected light according to paragraph 2.1. below on the sample with the highest CIL concerned shall be examined.
  - 4.9.3.1.4.3. Test of clearance to ground according to paragraph 5..
  - 4.9.3.1.4.4. Mechanical solidity test according to paragraph 6..
- 4.9.3.1.5. One sample other than those referred to in paragraph 1.4. above shall be subjected to the following tests:
  - 4.9.3.1.5.1. Testing of resistance to penetration of water into the retro-reflecting device according to paragraph 11.1. below or if relevant, of the mirror-backed reverse side of the retro-reflecting device, according to paragraph 11.2..
- 4.9.3.1.6. The second sample, other than those referred to in paragraph 1.4. above, shall be subjected to the following tests:
  - 4.9.3.1.6.1. Water test according to paragraph 8..
  - 4.9.3.1.6.2. Testing of resistance to fuels according to paragraph 9..
  - 4.9.3.1.6.3. Test of stability against wind according to paragraph 10. below.
- 4.9.3.1.7. After the tests specified in paragraph 1.4., the two samples submitted according to paragraph 3.5. of this Regulation shall be subjected to the following tests:
  - 4.9.3.1.7.1. Colour test according to paragraph 2.2.;
  - 4.9.3.1.7.2. Test of the luminance factor according to paragraph 3.;
  - 4.9.3.1.7.3. Test of weather resistance according to paragraph 12..

## 5. CONFORMITY OF PRODUCTION

- 5.1 The conformity of production procedures shall comply with those set out in the Rev.3 of the Agreement, with the following requirements:
- 5.1.1. **Retro-reflectors approved** under this Regulation shall be so manufactured as to conform to the type approved by meeting the requirements set forth in **paragraphs 6. and 7.** above.
- 5.1.1.1. The minimum requirements for conformity of production control procedures set forth in **Annex 17** shall be complied with.
- 5.1.1.2. The minimum requirements for sampling by an inspector set forth in **Annex 18** to this Regulation shall be complied with.
- 5.1.1.3. The authority which has granted type approval may at any time verify the conformity control methods applied in each production facility. The normal frequency of these verifications shall be once every two years.
- 5.1.2. **Advance warning triangles** approved under this Regulation shall be so manufactured as to conform to the type approved under this Regulation.
- The compliance with the requirements set forth in **paragraphs 6., 7. and 8** shall be verified as follows:
- 5.1.2.1. In addition, the stability in time of the optical properties and colour of retro-reflecting optical units of advance warning triangles conforming to an approved type and in use shall be verified. In the event of a systematic deficiency of the retro-reflecting optical units of advance warning triangles in use and conforming to an approved type, approval may be withdrawn. A "systematic deficiency" shall be deemed to exist where an approved type of advance warning triangle fails to meet the requirements of **paragraph 6.2.** .
- 5.1.2.2. The minimum requirements for conformity of production control procedures set forth in **Annex 7** shall be complied with.
- 5.1.2.3. The minimum requirements for sampling by an inspector set forth in **Annex 8** shall be complied with.
- 5.1.2.4. The Type Approval Authority which has granted type approval may at any time verify the conformity control methods applied in each production facility. The normal frequency of these verifications shall be once every two years.
- 5.1.3. **Rear marking plates ( and SMV)** approved under this Regulation shall be so manufactured as to conform to the type approved by meeting the requirements set forth in **paragraphs 6 and 7.**
- 5.1.3.1. The minimum requirements for conformity of production control procedures set forth in **Annex 13** shall be complied with.
- 5.1.3.2. The minimum requirements for sampling by an inspector set forth in Annex 14 shall be complied with.
- 5.1.3.3. The authority which has granted type approval may at any time verify the conformity control methods applied in each production facility. The normal frequency of these verifications shall be once every two years.

- 5.1.4. Any retro-reflective marking material approved to this Regulation shall be so manufactured as to conform to the type approved by meeting the requirements set forth in paragraphs 6 and 7 above.
- 5.1.4.1 The conformity of production shall not be contested if the mean value of the photometric measurements of five specimens taken at random deviates unfavourably by not more than 20 per cent from the prescribed values given in Annex 7.
- 5.1.4.2. The conformity of production shall not be contested, if the mean value of the colorimetric properties of five specimens taken at random meet the specifications of Annex 6 to be judged by visual inspection.
- 5.1.4.3. The authority which has granted type approval may at any time verify the conformity control methods applied in each production facility. The normal frequency of these verifications shall be once every two years.



## **6. MODIFICATION AND EXTENSION**

- 6.1. Every modification of the triangle type, the rear marking plate type, shall be notified to the Type Approval Authority which granted approval. The Type Approval Authority may then either:
- 6.1.1 Consider that the modifications made are unlikely to have an appreciable adverse effect, and that in any case the triangle type, the rear marking plate or retroreflective of device still meets the requirements; or
- 6.1.2. Require a further report from the technical service responsible for conducting the tests.
- 6.2. Notice of confirmation of approval, specifying the modifications, or of refusal of approval shall be communicated by the procedure specified in paragraph 5.3. above to the Parties to the Agreement which apply this Regulation.
- 6.3 Confirmation or refusal of approval, specifying the alterations, shall be notified by the procedure specified in paragraph 5.3 above to the Parties to the Agreement applying this Regulation.
- 6.4 The Type Approval Authority issuing the extension of approval shall assign a series number to each communication form drawn up for such an extension and inform thereof the other Parties to the 1958 Agreement applying this Regulation by means of a communication form conforming to the model in Annex 1.
- 6.5. The Competent Authority issuing the extension of approval shall assign a series number for such an extension and inform thereof the other Parties to the 1958 Agreement applying this Regulation by means of a communication form conforming to the model in Annex 2 to this Regulation.

## **7. PENALTY FOR NON CONFORMITY OF PRODUCTION**

7.1 The approval granted for a type of retro-reflecting device, advance warning triangle, rear marking plate or retro-reflective marking material may be withdrawn if the requirements are not complied with or if a retro-reflecting device bearing the approval mark does not conform to the type approved.

7.2. If a Contracting Party to the Agreement applying this Regulation withdraws an approval it has previously granted, it shall forthwith so notify the other Contracting Parties applying this Regulation by means of a communication form conforming to the model in Annex 2 to this Regulation.

## **8. PRODUCTION DEFINITELY DISCONTINUED**

If the holder of the approval completely ceases the manufacture of an SMV rear marking plate retro-reflective marking material approved in accordance with this Regulation, he shall so inform the authority which granted the approval. Upon receiving the relevant communication, that authority shall inform thereof the other Parties to the Agreement applying this Regulation by means of a communication form conforming to the model in Annex 2 to this Regulation.

## **9. NAME AND ADDRESSED OF TECHNICAL SERVICES...**

The Contracting Parties to the Agreement applying this Regulation shall communicate to the United Nations secretariat the names and addresses of the technical services responsible for conducting approval tests and of the administrative departments which grant approval and to which forms certifying approval or extension or refusal or withdrawal of approval, issued in other countries, are to be sent.

## **10. TRANSITIONAL PROVISIONS**

**This section is reserved for future use.**

# Annex 1

## COMMUNICATION

(maximum format: A4 (210 x 297 mm))

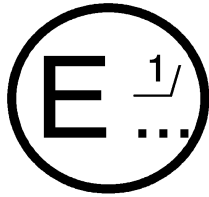

issued by: Name of administration:

.....  
.....  
.....

concerning: 2/ APPROVAL GRANTED  
APPROVAL EXTENDED  
APPROVAL REFUSED  
APPROVAL WITHDRAWN  
PRODUCTION DEFINITELY DISCONTINUED

of a type of retro-reflecting device

of a type of advance warning triangle

of a type of SMV rear marking plate

of a type of rear marking plate,

of retro-reflective markings of heavy and long vehicles and their trailers

Approval No: .....

Extension No:.....

1. Trade name mark of the marking material: .....
2. Manufacturer's name
  - 2.1 for the retro-reflecting type of device: .....
  - 2.2 Trade name or mark of the advance warning triangle .....
  - 2.3 SMV rear marking plate type: .....

- 2.4 Rear marking plate type:  
Rear marking plate class: .....
- 2.5 Trade name mark of the marking material  
Class of the marking material:
3. Name and address of the manufacturer: .....
4. If applicable, name and address of manufacturer's representative: .....  
.....
5. Date on which the marking material was submitted for approval tests: .....
6. Technical service responsible for carrying out the approval test: .....
7. Date of test report issued by the technical service: .....
8. Number of test report issued by the technical service: .....
9. Remarks: .....
10. Approval granted/refused/extended/withdrawn   /
11. Reason(s) for the extension (if applicable): .....  
.....
12. Place: .....
13. Date: .....
14. Signature: .....  
Name: .....
15. Annexed is a list of documents making up the approval file, deposited with the Competent Authority which granted approval; a copy can be obtained on request.

---

1/ Name of the administration.

2/ Strike out what does not apply.

## Annex 2

### Minimum requirements for conformity of production control procedures

1. General
  - 1.1. The conformity requirements shall be considered satisfied from a mechanical and geometric standpoint, if the differences do not exceed inevitable manufacturing deviations within the requirements of this Regulation.
  - 1.2. With respect to photometric performances, the conformity of mass-produced retro-reflectors shall not be contested if, when testing photometric performances of any retro-reflector chosen at random no measured value deviates unfavourably by more than 20 per cent from the minimum values prescribed in this Regulation.
  - 1.3. The chromaticity coordinates shall be complied with.
2. Minimum requirements for verification of conformity by the manufacturer

For each type of retro-reflector the holder of the approval mark shall carry out at least the following tests, at appropriate intervals. The tests shall be carried out in accordance with the provisions of this Regulation.

If any sampling shows non-conformity with regard to the type of test concerned, further samples shall be taken and tested. The manufacturer shall take steps to ensure the conformity of the production concerned.

  - 2.1. Nature of tests

Tests of conformity in this Regulation shall cover the photometric and colorimetric characteristics and the resistance to penetration of water.
  - 2.2. Methods used in tests
    - 2.2.1. Tests shall generally be carried out in accordance with the methods set out in this Regulation.
    - 2.2.2. In any test of conformity carried out by the manufacturer, equivalent methods may be used with the consent of the Type Approval Authority. The manufacturer is responsible for proving that the applied methods are equivalent to those laid down in this Regulation.
    - 2.2.3. The application of paragraphs 2.2.1. and 2.2.2. above requires regular calibration of test apparatus and its correlation with measurements made by a competent authority.
    - 2.2.4. In all cases the reference methods shall be those of this Regulation, particularly for the purpose of administrative verification and sampling.

2.3. Nature of sampling

Samples of retro-reflectors shall be selected at random from the production of a uniform batch. A uniform batch means a set of retro-reflectors of the same type, defined according to the production methods of the manufacturer.

The assessment shall in general cover series production from individual factories. However, a manufacturer may group together records concerning the same type from several factories, provided these operate under the same quality system and quality management.

2.4. Measured and recorded photometric characteristics

The sampled retro-reflector shall be subjected to photometric measurements at the points and the chromaticity coordinates provided for in the Regulation.

2.5. Criteria governing acceptability

The manufacturer is responsible for carrying out a statistical study of the test results and for defining, in agreement with the Type Approval Authority, criteria governing the acceptability of his products in order to meet the specifications laid down for the verification of conformity of products in paragraph 8.1. of this Regulation.

The criteria governing the acceptability shall be such that, with a confidence level of 95 per cent, the minimum probability of passing a spot check in accordance with Annex 18 (first sampling) would be 0.95.

## Annex 3

### MINIMUM REQUIREMENTS FOR SAMPLING BY AN INSPECTOR

#### 1. FIRST SAMPLING

In the first sampling four retro-reflectors are selected at random. The first sample of two is marked A, the second sample of two is marked B.

1.1. The conformity of mass-produced retro-reflectors shall not be contested if the deviation of any specimen of samples A and B (all four retro-reflectors)

is not more than 20 per cent.

In the case, that the deviation of both retro-reflectors of sample A

is not more than 0 per cent

the measurement can be closed.

1.2. The conformity of mass-produced retro-reflectors shall be contested if the deviation of at least one specimen of samples A or B

is more than 20 per cent.

The manufacturer shall be requested to bring his production in line with the requirements (alignment) and a repeated sampling according to paragraph 3. below shall be carried out within two months' time after the notification. The samples A and B shall be retained by the Technical Service until the entire COP process is finished.

#### 2. FIRST REPEATED SAMPLING

A sample of four lamps, is selected at random from stock manufactured after alignment. The first sample of two is marked C, the second sample of two is marked D.

2.1. The conformity of mass-produced retro-reflectors shall not be contested if the deviation of any specimen of samples C and D (all four retro-reflectors)

is not more than 20 per cent.

In the case, that the deviation of both retro-reflectors of sample C

is not more than 0 per cent

the measurement can be closed.

2.2. The conformity of mass-produced retro-reflectors shall be contested if the deviation of at least

2.2.1. one specimen of samples C or D is more than 20 per cent

but the deviation of all specimen of these samples is not more than 30 per cent.

The manufacturer shall be requested again to bring his production in line with the requirements (alignment).

A second repeated sampling according to **paragraph 4.** below shall be carried out within two months' time after the notification shall. The samples C and D shall be retained by the Technical Service until the entire COP process is finished.

2.2.2. one specimen of samples C and D is more than 30 per cent.

In this case the approval shall be withdrawn and paragraph 5 below shall be applied.

### 3. SECOND REPEATED SAMPLING

A sample of four lamps, is selected at random from stock manufactured after alignment. The first sample of two is marked E, the second sample of two is marked F.

3.1. The conformity of mass-produced retro-reflectors shall not be contested if the deviation of any specimen of samples E and F (all four retro-reflectors)

is not more than 20 per cent

In the case, that the deviation of both retro-reflectors of sample E

is not more than 0 per cent

the measurement can be closed.

3.2. The conformity of mass-produced retro-reflectors shall be contested if the deviation of at least

one specimen of samples E or F is more than 20 per cent.

In this case the approval shall be withdrawn and paragraph 5 below shall be applied.

### 4. Approval withdrawn

Approval shall be withdrawn according to **paragraph 9.**



## Annex 4

### PHOTOMETRIC MEASUREMENTS OF RETRO – REFLECTORS AND RETRO – REFLECTING DEVICES

1. Test Procedures
  - 1.1. When the CIL of a retro-reflecting device is measured for an angle  $\beta$  of  $V = H = 0^\circ$ , it shall be ascertained whether any mirror effect is produced by slightly turning the device. If there is any such effect, a reading shall be taken with an angle  $\beta$  of  $V = \pm 5^\circ$ ,  $H = 0^\circ$ . The position adopted shall be that corresponding to the minimum CIL for one of these positions.
  - 1.2. With an illumination angle  $\beta$  of  $V = H = 0^\circ$ , or the angle specified in paragraph 3.1. above, and an angle of divergence of  $20'$ , retro-reflecting devices which are not marked "TOP" shall be rotated about their axes of reference to the position of minimum CIL, which must conform to the value specified in paragraph 3. above. When the CIL is measured for the other angles of illumination and divergence, the retro-reflecting device shall be placed in the position corresponding to this value of  $\varepsilon$ . If the specified values are not attained, the device may be rotated about its axis of reference  $\pm 5^\circ$  from that position.
  - 1.3. With an illumination angle  $\beta$  of  $V = H = 0^\circ$ , or the angle specified in paragraph 4. above, and an angle of divergence of  $20'$ , retro-reflecting devices marked "TOP" shall be rotated about their axes  $\pm 5^\circ$ . The CIL must not fall below the prescribed value in any position assumed by the device during this rotation.
  - 1.4. If for the direction  $V = H = 0^\circ$ , and for  $\varepsilon = 0^\circ$  the CIL exceeds the specified value by 50 per cent or more, all measurements for all angles of illumination and divergence shall be made for  $\varepsilon = 0^\circ$ .
2. Definitions

Needed definitions are explained by [Figures 1 to 4.](#)
3. Dimensional and physical specifications for the photometry of retro-reflectors
  - 3.1. The CIE-angular system as shown in [Figure 1](#) shall be used.

An adequate support (goniometer) is demonstrated in [Figure 2.](#)
  - 3.2. For testing the retro-reflection the retro-reflective devices shall be illuminated with a CIE Standard illuminant A (ISO 11664-2:2007(E)/CIE S 014-2/E:2006) and measured as described in [Annex 4.](#)

- 3.3. The measuring geometry is described in **Figure 1** and the following limits are set up:
- Angular diameter of the source -  $\delta \leq 10'$
  - Angular diameter of the measuring device -  $\gamma \leq 10'$
  - Angular diameter of the illuminated area -  $\eta \leq 80'$
- 3.4. During photometric measurements, stray reflections should be avoided by appropriate masking.

Figure 1: Measuring geometry for the measurement of a retro-reflecting device

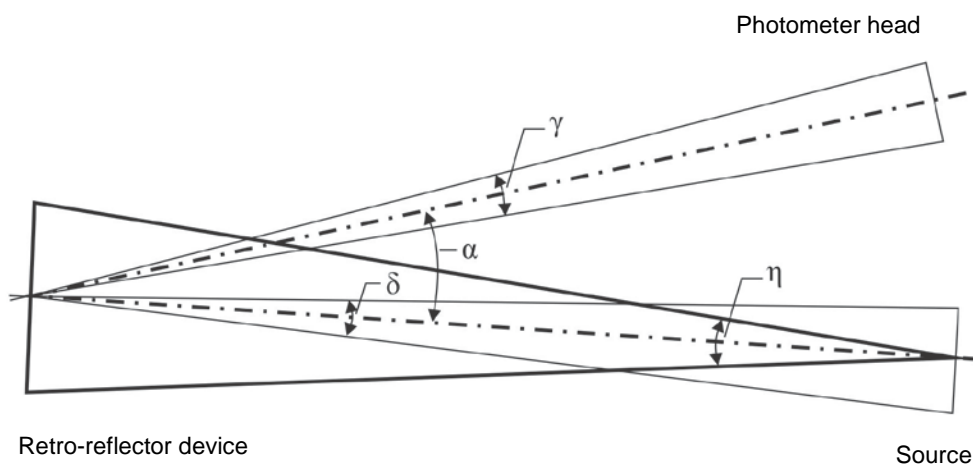

- 3.5. The measuring distance shall be chosen in such an order that at least the limits for the angles  $\delta$ ,  $\gamma$  and  $\eta$  given in Figure 4 are respected, but not lower than 10 m or its optical equivalent.

The retro-reflection values shall be determined by means of a measuring geometry as described above with the retro-reflecting device set up to a distance of at least 10 m forward of the centre of reference of each retro-reflecting device perpendicular to the measurement axis from the origin of the gonio(photo)meter system.

- 3.6. The illuminance at the retro-reflector

The illuminance over the useful area of the retro-reflector, measured perpendicular to the incident light shall be sufficiently uniform. A check on this condition requires a measuring element, the sensitive area of which is not greater than one-tenth of the area to be examined. The variation in the value of the illuminance shall then comply with the condition:

$$\frac{\text{maximum value}}{\text{minimum value}} \leq 1.05$$

- 3.7. The colour temperature and the spectral distribution of the source

The source used for illuminating the retro-reflector shall as faithfully as possible represent the CIE illuminant A, both as regards colour temperature and spectral power distribution.
- 3.8. The photometer head (measuring element)
  - 3.8.1. The photometer head shall be corrected to the spectral luminous efficiency for the CIE standard photometric observer in photopic vision.
  - 3.8.2. The device shall not show a perceptible change in local sensitivity within the area of its aperture; otherwise suitable provisions shall be added, e.g. the application of a diffusing window at a certain distance in front of the sensitive surface.
  - 3.8.3. Experience has shown that non-linearity of photometer heads may be a problem with the very small light quantities which are the rule in the photometry of retro-reflectors. A check at comparable illuminance levels on the photometer head is recommended.
- 3.9. The influence of a regular reflection

The amount and distribution of the regular reflection from the surface of the retro-reflector depends on the flatness and the gloss of the surface. In general, regular reflection is best avoided when the reference axis is placed so that the regular reflection is directed on the opposite side of the source from the photometer head (for example with  $\beta_1 = -5^\circ$ ).
4. Measurement precautions in the photometry of retro-reflection
  - 4.1. Residual and stray light
    - 4.1.1. Since very low light levels are to be measured special precautions are needed to minimize errors due to stray light. The background to the sample and the framework of the sample holder should be matt black and the field of view of the photometer head and the spread of light from both the sample and the source should each be restricted as much as possible.
    - 4.1.2. Reflections from the floor and walls which occur over the relatively long test distances used shall be screened from both the sample and the photometer head by baffles. The importance of looking from the photometer head to check for sources of stray light cannot be over emphasized.
    - 4.1.3. A valuable aid to reducing the amount of stray light in the laboratory is to use a slide projector type of optical system for the light source. With this, an iris diaphragm or suitable sized apertures may be used in the optical system to restrict the illuminated area at the sample to the minimum size needed to provide uniform illuminance over the sample.
    - 4.1.4. Residual stray light should always be allowed for by measuring it when the sample is covered by an opaque matt black surface, zigzag folded black paper of the same size and shape or a specular black surface suitably oriented with a light trap. This value should be subtracted from that measured on the retro-reflector.
  - 4.2. Stability of the apparatus
    - 4.2.1. The light source and photometer head should remain stable throughout the period of the test. Since the sensitivity and the adaptation to the  $V(\lambda)$  function of most photometer heads change with temperature, the laboratory ambient temperature should not vary significantly during this period. Sufficient time should always be allowed for the apparatus to stabilize before commencing measurements.

- 4.2.2. The power supply to the light source should be adequately stabilized so that the luminous intensity of the lamp can be maintained throughout the test to within the required accuracy for the work.
- 4.2.3. A useful check on the overall stability of the reflex photometer during a series of tests is to make periodic measurements of CIL values of a stable reference standard.
- 4.2.4. Another technique is to incorporate in the apparatus an auxiliary detector to check or monitor the output of the light source. Although the output from the auxiliary detector can be checked for any change in reading, a useful refinement is to use the output to alter electronically the sensitivity of the main reflex photometer head and compensate automatically for changes in the light output of the source.

### **For the purpose of this Annex (Definitions Retro-Reflectors)**

- 5. "Retro-reflection" means the reflection in which light is reflected in directions close to the direction from which it came. This property is maintained over wide variations of the illumination angle.
- 5.1. "Retro-reflecting optical unit" means a combination of optical components producing retro-reflection.
- 5.2. "Retro-reflecting device" 1/ means an assembly ready for use and comprising one or more retro-reflecting optical units.
- 5.3. "Angle of divergence" means the angle between the straight lines connecting the centre of reference to the centre of the receiver and to the centre of the source of illumination.
- 5.4. "Illumination angle" means the angle between the axis of reference and the straight line connecting the centre of reference to the centre of the source of illumination.
- 5.5. "Angle of rotation" means the angle through which the retro-reflecting device is rotated about its axis of reference starting from one given position.
- 5.6. "Angular diameter of the retro-reflecting device" means the angle subtended by the greatest dimension of the visible area of the illuminating surface, either at the centre of the source of illumination or at the centre of the receiver.
- 5.7. "Illumination of the retro-reflecting device" is the abbreviated expression used conventionally to designate the illumination measured in a plane perpendicular to the incident rays and passing through the centre of reference.
- 5.8. "Coefficient of luminous intensity (CIL)" means the quotient of the luminous intensity reflected in the direction considered, divided by the illumination of the retro-reflecting device for given angles of illumination, divergence and rotation.

## For the purpose of this Annex (Definitions CIE-Goniometer System Retro-Reflecting materials)

6. Geometric definitions (see Annex 1, figure 1)
- 6.1. "Reference centre" means a point on or near a retro-reflective area which is designated to be the centre of the device for the purpose of specifying its performance;
- 6.2. "Illumination axis (symbol I)" means a line segment from the reference centre to the light source.
- 6.3. "Observation axis (symbol O)" means a line segment from the reference centre to the photometer head;
- 6.4. "Observation angle (symbol  $\alpha$ )" means the angle between the illumination axis and the observation axis. The observation angle is always positive and, in the case of retro-reflection, is restricted to small angles;
- 6.5. "Observation on half-plane" means the half-plane which originates on the illumination axis and which contains the observation axis;
- 6.6. "Reference axis (symbol R)" means a designated line segment originating on the reference centre which is used to describe the angular position of the retro-reflective device;
- 6.7. "Entrance angle (symbol  $\beta$ )" means the angle from the illumination axis to the reference axis. The entrance angle is usually not larger than  $90^\circ$  but, for completeness, its full range is defined as  $0^\circ < \beta < 180^\circ$ . In order to specify the orientation in full, this angle is characterised by two components,  $\beta_1$  and  $\beta_2$ ;
- 6.8. "Rotation angle (symbol  $\varepsilon$ )" means the angle indicating the orientation of the retro-reflecting material by an appropriate symbol with respect to rotation about the reference axis. If retro-reflective materials or devices have a marking (e.g.TOP), this marking governs the starting position.  
The angle of rotation  $\varepsilon$  lies in the range  $-180^\circ < \varepsilon < +180^\circ$ .
- 6.9. "First axis (symbol 1)" means an axis through the reference centre and perpendicular to the observation half-plane;
- 6.10. "First component of the entrance angle (symbol  $\beta_1$ )" means the angle from the illumination axis to the plane containing the reference axis and the first axis;  
range:  $-180^\circ < \beta_1 < 180^\circ$ ;
- 6.11. "Second component of the entrance angle (symbol  $\beta_2$ )" means the angle from the plane containing the observation half-plane to the reference axis;  
range  $-90^\circ < \beta_2 < 90^\circ$ ;
- 6.12. "Second axis (symbol 2)" means an axis through the reference centre and perpendicular to both the first axis and the reference axis. The positive direction of the second axis lies in the observation half-plane when  $-90^\circ < \beta_1 < 90^\circ$  as shown in Annex 1, figure 1.

7.1. Definition of photometric terms

7.1.1. "Coefficient of retro-reflection (symbol R')" means the quotient of the coefficient of luminous intensity R of a plane retro-reflecting surface and its area A

$$\left( R' = \frac{R}{A} \right) \quad \text{The coefficient of retro-reflection R' is expressed}$$

in candelas per m<sup>2</sup> per lx (cd.m<sup>-2</sup>.lx<sup>-1</sup>)

$$\left( R' = \frac{I}{E_{\perp} \cdot A} \right) \quad (\text{Luminance / Illumination});$$

7.1.2. "Angular diameter of the retro-reflector sample (symbol  $\eta_1$ )" means the angle subtended by the greatest dimension of the retro-reflective sample, either at the centre of the source of illumination or at the centre of the receiver ( $\beta_1 = \beta_2 = 0^\circ$ );

7.1.3. "Angular diameter of the receiver (symbol  $\eta_2$ )" means the angle subtended by the greatest dimension of the receiver as seen from the reference centre ( $\beta_1 = \beta_2 = 0^\circ$ );

7.1.4. "Luminance factor (symbol  $\beta$ )" means the ratio of the luminance of the body to the luminance of a perfect diffuser under identical conditions of illumination and observation;

7.1.5. "Colour of the reflected light of the device" The definitions of the colour of the reflected light are given in [Annex 4](#).

7.2. Description of Goniometer

A goniometer **as defined in paragraph 2.1.7.**, which can be used in making retro-reflection measurements in the CIE geometry is illustrated **in Annex 1, figure 2**. In this illustration, the photometer head (O) is arbitrarily shown to be vertically above the source (I). The first axis is shown to be fixed and horizontal and is situated perpendicular to the observation half-plane. Any arrangement of the components which is equivalent to the one shown can be used.

Figure 1: The CIE angular system for specifying and measuring retro-reflective marking materials. The first axis is perpendicular to the plane containing the observation axis and the illumination axis. The second axis is perpendicular both to the first axis and to the reference axis.

Figure 2: Representation of a Goniometer mechanism embodying the CIE angular system for specifying and measuring retro-reflective materials

All axes, angles, and directions of rotation are shown positive.

Notes:

- (a) The principle fixed axis is the illumination axis.
- (b) The first axis is fixed perpendicular to the plane containing the observation and illumination axis.
- (c) The reference axis is fixed in the retro-reflective material and moveable with  $\beta_1$  and  $\beta_2$ .

Figure 1: THE CIE CO-ORDINATE SYSTEM

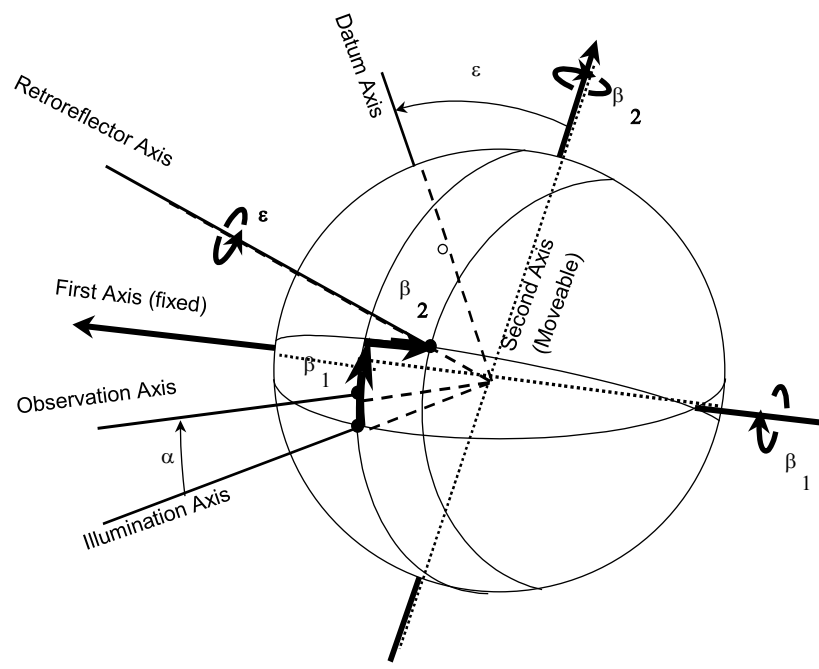
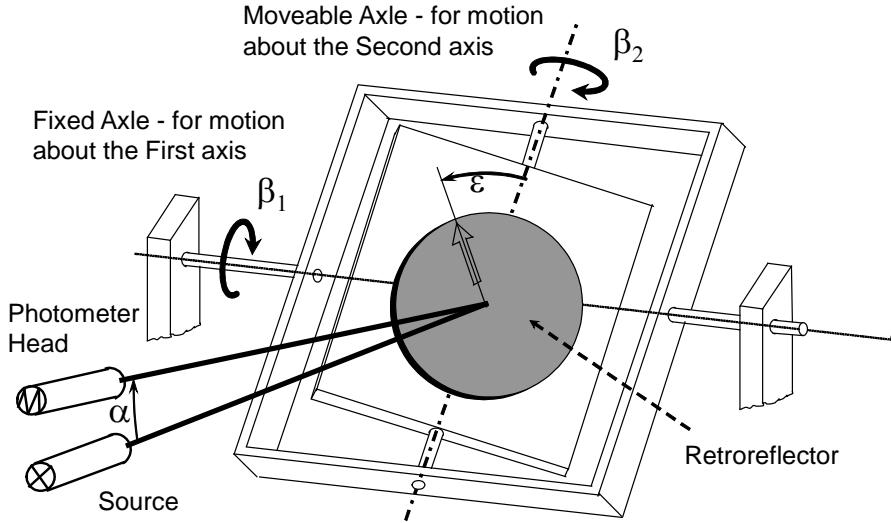

Figure 2 GONIOMETER MECHANISM EMBODYING THE CIE ANGULAR SYSTEM



- |                |                              |   |
|----------------|------------------------------|---|
| 1: First Axis  | I: Illumination Axis         | α: Observation angle                              |
| 2: Second Axis | O: Observation Axis          | β <sub>1</sub> , β <sub>2</sub> : Entrance angles |
|                | R: Reference Axis            | ε: Rotation angle                                 |
|                | P: Retro-reflective material |   |

## Arrangement of the test equipment for retro-reflectors as Classes IA, IB, IIIA, IIIB, IVA:

### Symbols

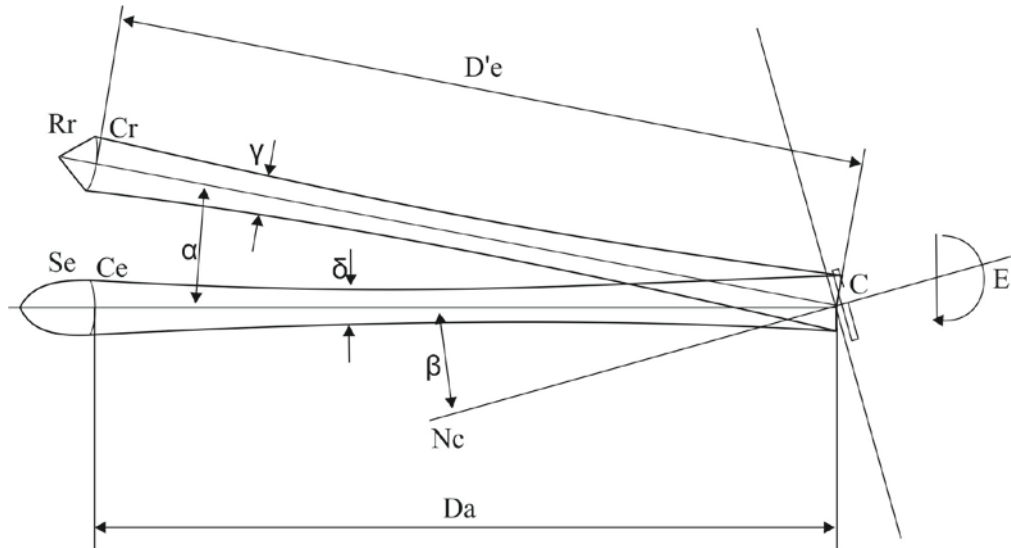

Elevation

### Symbols and units

A = Area of the illuminating surface of the retro-reflecting device (cm<sup>2</sup>)

C = Centre of reference

NC = Axis of reference

Rr = Receiver, observer or measuring device

Cr = Centre of receiver

Ør = Diameter of receiver Rr if circular (cm)

Se = Source of illumination

Cs = Centre of source of illumination

Øs = Diameter of source of illumination (cm)

De = Distance from centre Cs to centre C (m)

D'e = Distance from centre Cr to centre C (m)

*Note:* In general, De and D'e are very nearly the same and under normal conditions of observation it may be assumed that De = D'e.

D = Observation distance from and from beyond which the illuminating surface appears to be continuous



$\alpha$	=	Angle of divergence
$\beta$	=	Illumination angle. With respect to the line CsC which is always considered to be horizontal, this angle is prefixed by the signs - (left), + (right), + (up) or - (down), according to the position of the source Se in relation to the axis NC, as seen when looking towards the retro-reflecting device. For any direction defined by two angles, vertical and horizontal, the vertical angle is always given first.
$\gamma$	=	Angular diameter of the measuring device Rr as seen from point C
$\delta$	=	Angular diameter of the source Se as seen from point C
$\varepsilon$	=	Angle of rotation. This angle is positive when the rotation is clockwise as seen when looking towards the illuminating surface. If the retro-reflecting device is marked "TOP", the position thus indicated is taken as the origin.
E	=	Illumination of the retro-reflecting device (lux)
CIL	=	Coefficient of luminous intensity (millicandelas/lux) Angles are expressed in degrees and minutes.

## Annex 5

### Specifications of shape and dimensions

1. Shape and dimensions of retro-reflecting devices in Class IA or IB
  - 1.1. The shape of the illuminating surfaces must be simple, and not easily confused at normal observation distances, with a letter, a digit or a triangle.
  - 1.2. The preceding paragraph notwithstanding, a shape resembling the letters or digits of simple form O, I, U or 8 is permissible.
2. Shape and dimensions of retro-reflecting devices in Classes IIIA and IIIB (see appendix to this annex)
  - 2.1. The illuminating surfaces of retro-reflecting devices in Classes IIIA and IIIB must have the shape of an equilateral triangle. If the word "TOP" is inscribed in one corner, the apex of that corner must be directed upwards.
  - 2.2. The illuminating surface may or may not have at its centre a triangular, non-retro-reflecting area, with sides parallel to those of the outer triangle.
  - 2.3. The illuminating surface may or may not be continuous. In any case, the shortest distance between two adjacent retro-reflecting optical units must not exceed 15 mm.
  - 2.4. The illuminating surface of a retro-reflecting device shall be considered to be continuous if the edges of the illuminating surfaces of adjacent separate optical units are parallel and if the said optical units are evenly distributed over the whole solid surface of the triangle.
  - 2.5. If the illuminated surface is not continuous, the number of separate retro-reflecting optical units including the corner units shall not be less than four on each side of the triangle.
    - 2.5.1. The separate retro-reflecting optical units shall not be replaceable unless they consist of approved retro-reflecting devices in Class IA.
  - 2.6. The outside edges of the illuminating surfaces of triangular retro-reflecting devices in Classes IIIA and IIIB shall be between 150 and 200 mm long. In the case of devices of hollow-triangle type, the width of the sides, measured at right angles to the latter, shall be equal to at least 20 per cent of the effective length between the extremities of the illuminating surface.
3. Shape and dimensions of retro-reflecting devices in Class IVA
  - 3.1. The shape of the light emitting surfaces must be simple and not easily confused at normal observation distances with a letter, a digit or a triangle. However, a shape resembling the letters and digits of simple form, O, I, U and 8 is permissible.
  - 3.2. The light emitting surface of the retro-reflecting device must be at least 25 cm<sup>2</sup>.
  - 3.3. Compliance with the above specifications shall be verified by visual inspection.

## Retro-reflectors for trailers - Classes IIIA and IIIB

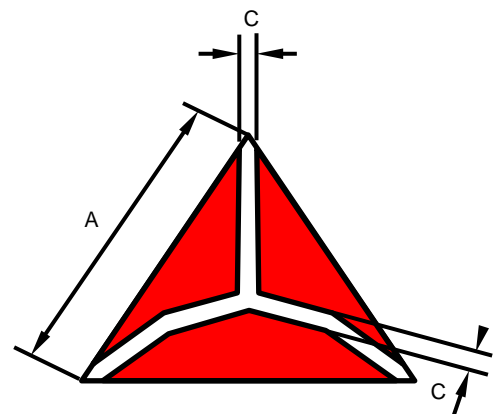
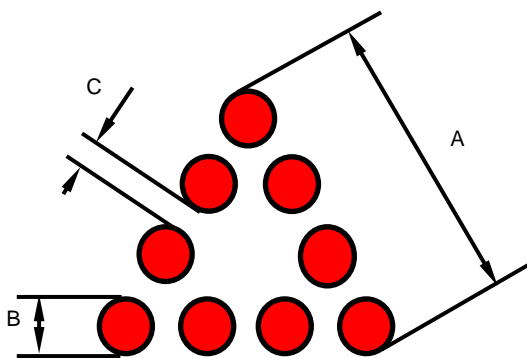
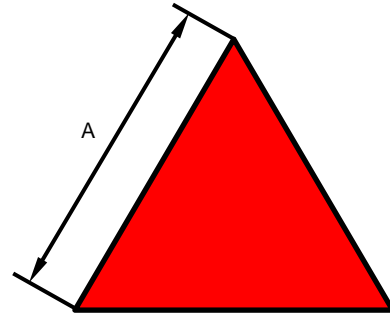
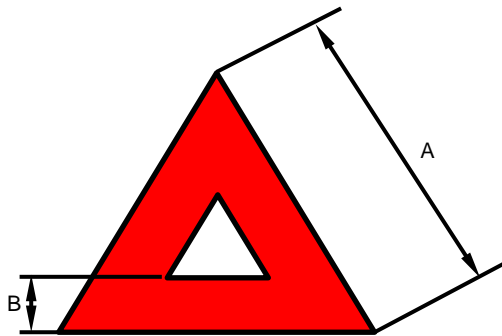

$150 \text{ mm} \leq A \leq 200 \text{ mm}$ $B \geq \frac{A}{5}$ $C \leq 15 \text{ mm}$
---

*Note:* These sketches are for illustration purposes only.

## SIDE AND REAR MARKING WITH STRIPS

### 1.1. General

The markings shall be made of strips of retro-reflective material.

### 1.2. Dimensions

1.2.1. The width of a side and/or rear marking material shall be 50 mm +10/-0 mm.

1.2.2. The minimum length of an element of a retro-reflective marking material shall be such that at least one approval mark is visible.

## 4. Side, rear and/or front marking with strips (Class F) Retroreflective Markings Plates of the Class 5

### 4.1. General

The markings shall be made of strips of retro-reflective material.

### 4.2. Dimensions

4.2.1. Class F retro-reflective materials shall consist of red and white diagonal stripes each 100 mm wide sloping outwards and downwards at 45°. The basic standard area is a square of 141 mm in length subdivided diagonally into a white half and red half, which represents one standard area as shown in Figure 1.

4.2.2. The minimum length of an element of a retro-reflective marking material shall incorporate a minimum of 9 standard areas as described in paragraph 2.2.1, above on large vehicles with available mounting space, but may be reduced to a minimum of 4 standard areas on vehicles with limited mounting space."

"Figure 1 : Retro-reflective material marking of Class F (Standard Element)

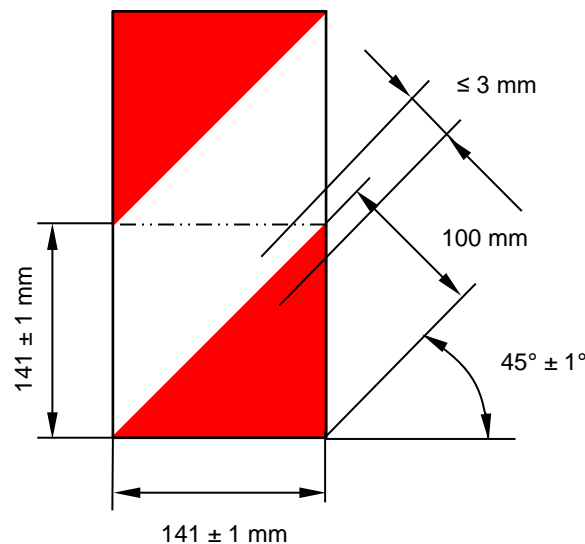

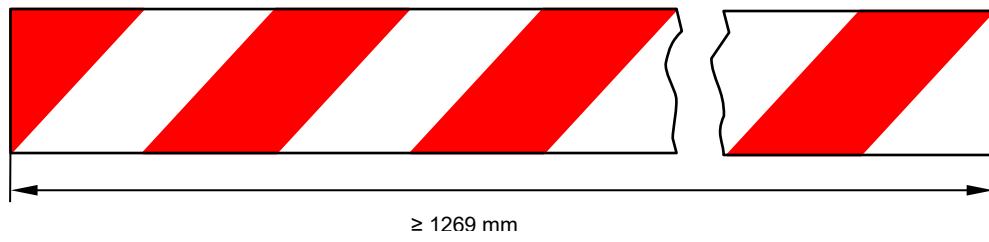

"Figure 2 : Retro-reflective material marking of Class F

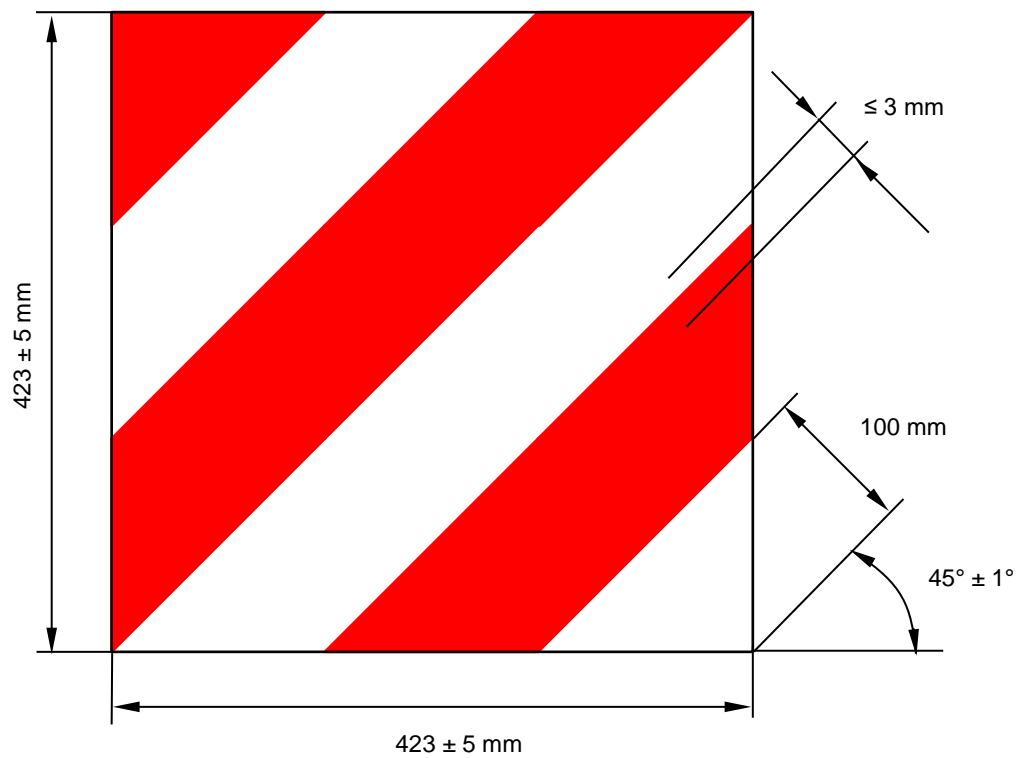

"Figure 3 : Retro-reflective material marking of Class 5

## SHAPE AND DIMENSIONS OF RETRO-REFLECTIVE/FLUORESCENT REAR MARKING PLATE(S)

### 5.1. Shape

The plates shall be rectangular in shape for mounting at the rear of vehicles.

### 5.2. Pattern

For mounting on trailers and semi-trailers, the plates shall have a yellow retro-reflective background with a red fluorescent or retro-reflective border;

For mounting on non-articulated vehicles (tractors or trucks), the plates shall be of the chevron type with alternate, oblique stripes of yellow retro-reflective and red fluorescent or retro-reflective materials or devices.

### 5.3. Dimensions

The minimum total summarized length of a set of rear marking plates consisting only of one, two or four marking plates with retro-reflective and fluorescent materials shall be 1,130 mm, the maximum total length shall be 2,300 mm.

#### 5.3.1. The width of a rear marking plate shall be:

For trucks and tractors:  $140 \pm 10$  mm.

For trailers and semi-trailers:  $200^{+30}_{-5}$  mm.

#### 5.3.2. The length of each rear marking plate in a set consisting of two plates for trucks and tractors, as illustrated in figures 1(b) and 1(c) of Annex 12, may be reduced, to a minimum of 130 mm, provided that the width is increased such that the area of each marking is at least $735 \text{ cm}^2$ , does not exceed $1,725 \text{ cm}^2$ and the marking plates are rectangular.

#### 5.3.3. The width of the red fluorescent border of the rear marking plates for trailers and semi-trailers shall be $40 \text{ mm} \pm 1$ mm.

#### 5.3.4. The slope of the oblique stripes of the chevron band shall be $45^\circ \pm 5^\circ$ . The width of the stripes shall be $100 \text{ mm} \pm 2.5$ mm.

Prescribed shapes, patterns and dimensional features are illustrated in figures 1 and 2 of Annex 12 to this Regulation.

#### 5.3.5. Rear marking plates supplied in sets shall form matching pairs.

# REAR MARKING PLATES (CLASS 1 AND CLASS 3)

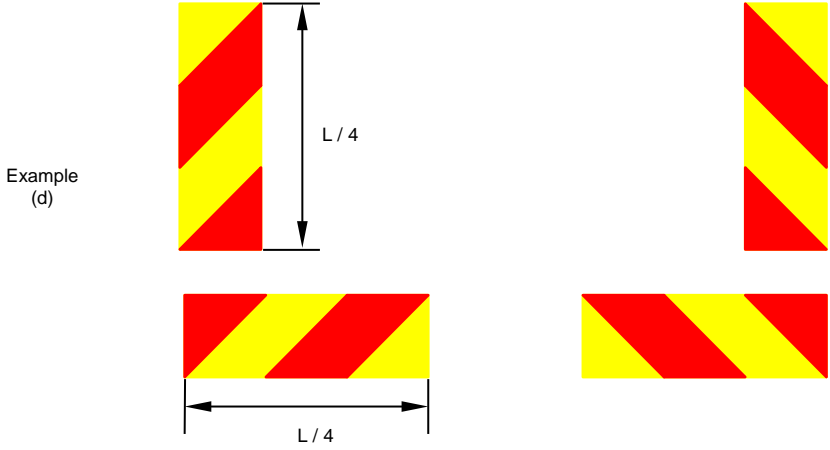
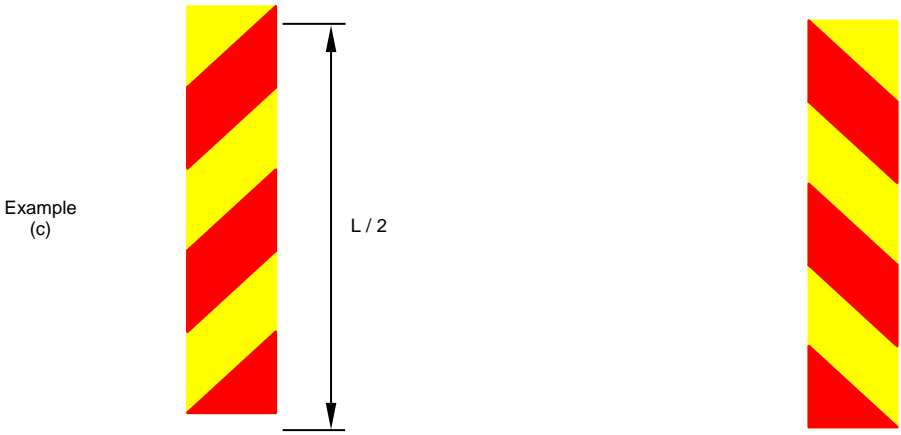
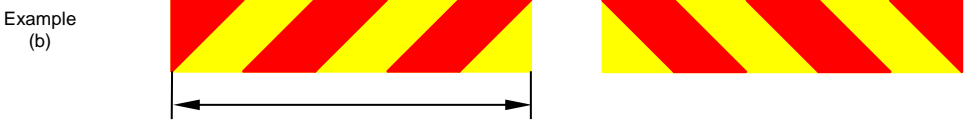
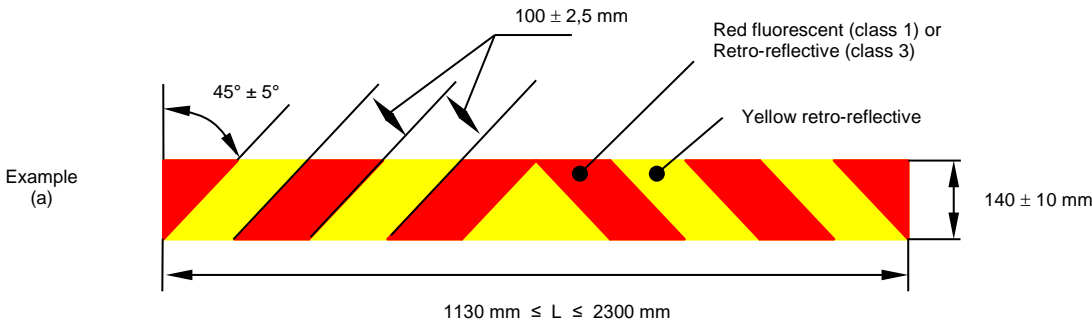

## REAR MARKING PLATES (CLASS 2 AND CLASS 4)

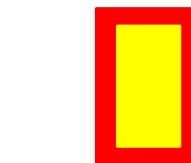
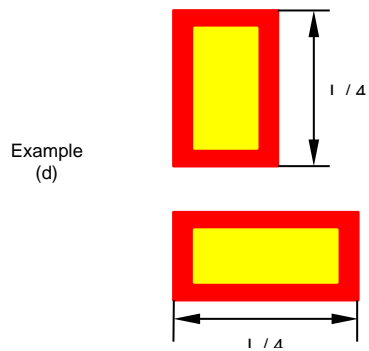
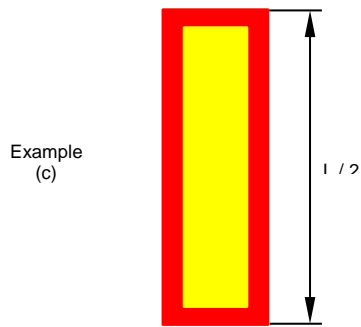
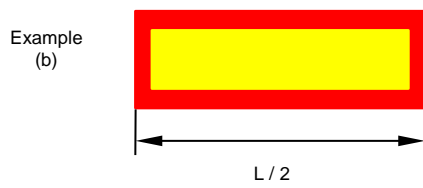
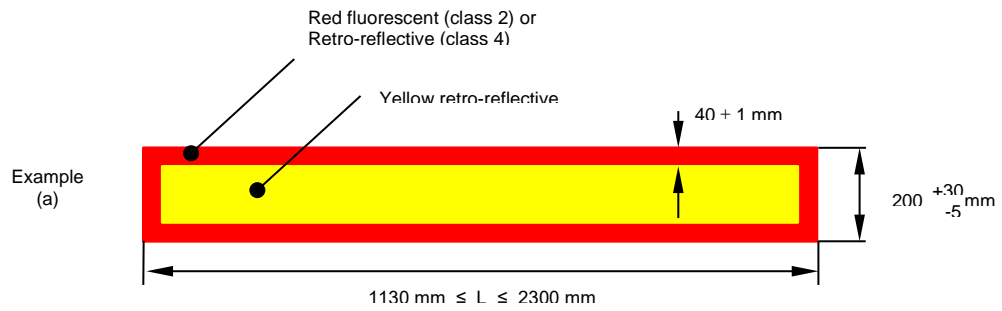



## SHAPE AND DIMENSIONS OF RETRO-REFLECTIVE/FLUORESCENT (CLASS 1) OR RETRO-REFLECTIVE ONLY (CLASS 2) SMV REAR MARKING PLATES

### 6.1. Shape

The plates shall be in the shape of an equilateral triangle with truncated corners, for mounting with one apex upwards at the rear of slow-moving vehicles.

### 6.2. Pattern

The SMV rear marking plates shall have a red fluorescent centre and red retro-reflective borders made of either retro-reflective sheeting or coating or of plastic corner-cube reflectors (class 1). The SMV rear marking plates of class 2 shall have a retro-reflective centre.

### 6.3. Dimensions

The length of the base of the enclosed fluorescent triangle (class 1) or retro-reflective triangle (class 2) shall be: minimum 350 mm and maximum 365 mm. The minimum width of the light-emitting surface of the red retro-reflective border shall be 45 mm, the maximum width 48 mm. These features are illustrated in the example of [Annex 12](#).

### 6.4. REAR MARKING PLATES FOR SLOW-MOVING VEHICLES AND THEIR TRAILERS

#### Example

All dimensions in mm

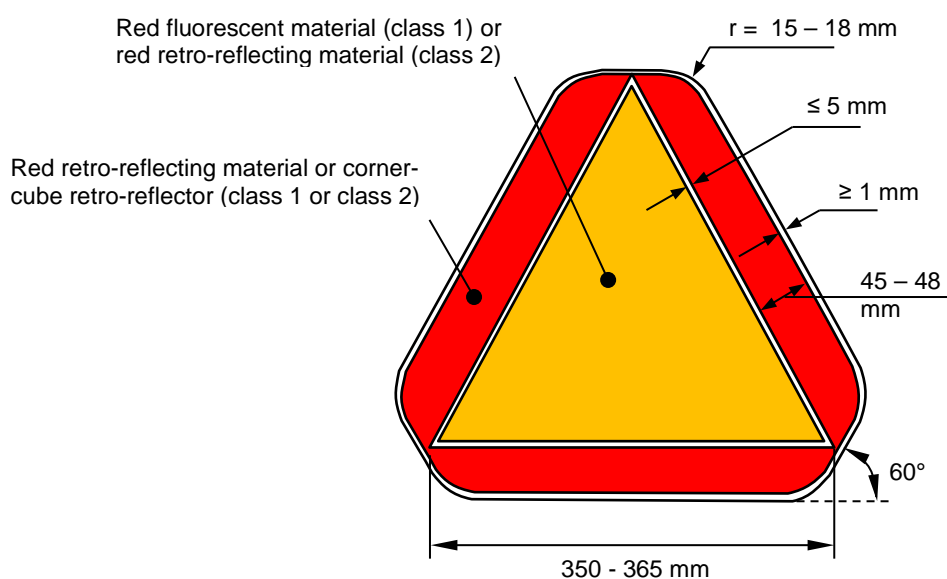

## Shape and dimensions of the advance warning triangle

**Figure 1**

Shape and dimensions of the advance warning triangle of type 1 and of the support

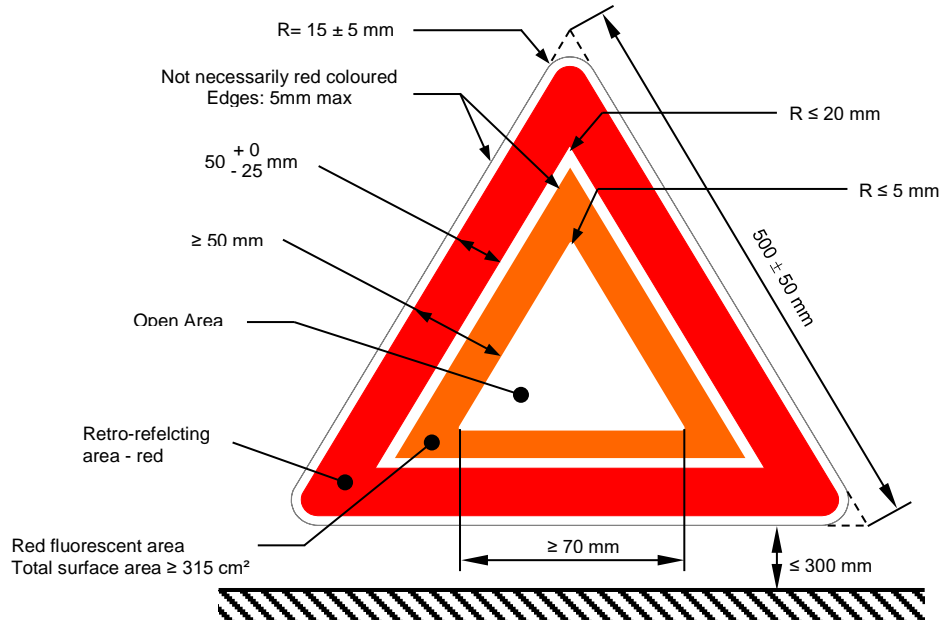

**Figure 2**

Shape and dimensions of the advance warning triangle of type 2 and of the support

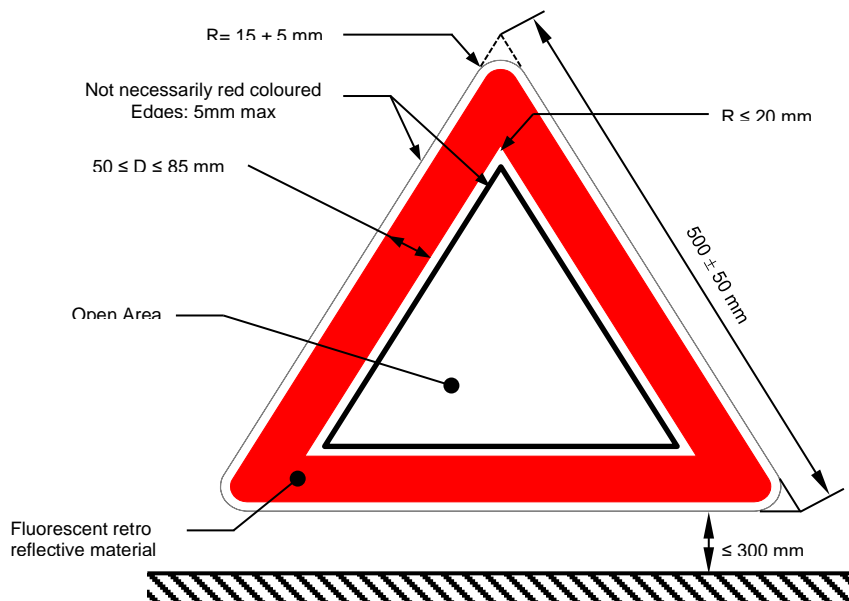
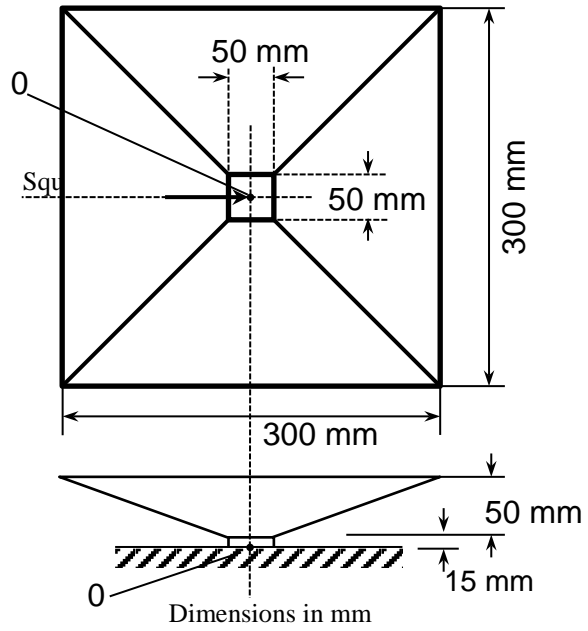

Figure 3  
Test device for clearance to ground



## Annex 6

### Resistance to heat

- 1. Test procedure in the case of moulded plastics reflectors of retro-reflecting devices (as Classes IA, IB, IIIA, IIIB, IVA, SMV, [1, 2, 3, 4, 5,] and Advance warning triangle of type 1**
  - 1.1. The retro-reflecting device shall be kept for 48 consecutive hours in a dry atmosphere at a temperature of  $65\text{ }^{\circ}\text{C} \pm 2\text{ }^{\circ}\text{C}$  after which the sample shall be allowed to cool for 1 hour at  $23 \pm 2^{\circ}\text{C}$ .
  
- 2 Test procedure in the case of use of flexible materials for Classes C, F, 1, 2, 3, 4, 5 and Advance warning triangle of type 2**
  - 2.1. A section of a sample unit not less than 300 mm long shall be kept for 12 hours in a dry atmosphere at a temperature of  $65 \pm 2^{\circ}\text{C}$ , after which the sample shall be allowed to cool for 1 hour at  $23 \pm 2^{\circ}\text{C}$ . It shall then be kept for 12 hours at a temperature of  $-20 \pm 2^{\circ}\text{C}$ .
    - 2.1.1. The sample shall be examined after a recovery time of 4 hours under normal laboratory conditions.
  
  3. After this test, no cracking or appreciable distortion of the retro-reflecting device and, in particular, of its optical component must be visible [evident].

## Annex 7

### Resistance to water penetration for retro-reflecting devices of the Classes IB, and IIB and Advance warning triangles

1. Test for retro-reflecting devices except for the Classes IB, IIB
  - 1.1. Retro-reflecting devices whether part of a lamp or not or a sample unit of retro-reflective marking, shall be stripped of all removable parts and immersed for 10 minutes in water at a temperature of  $50 \pm 5$  °C, the highest point of the upper part of the illuminating surface being 20 mm below the surface of the water. This test shall be repeated after turning the retro-reflecting device through 180°, so that the illuminating surface is at the bottom and the rear face is covered by about 20 mm of water. These ~~optical~~ **sample** units shall then be immediately immersed in the same conditions in water at a temperature of  $25 \pm 5$  °C.
  - 1.2. No water shall penetrate to the reflecting surface of the retro-reflecting optical unit. If visual inspection clearly reveals the presence of water, the device shall not be considered to have passed the test.
  - 1.3. If visual inspection does not reveal the presence of water or in case of doubt:
    - 1.3.1. In the case of retro-reflectors, the CIL shall be measured by the method described in Annex 4, paragraph 3.2., or Annex 14, paragraph 4.2., the retro-reflecting device being first lightly shaken to remove excess water from the outside.
    - 1.3.2. In the case of a sample unit of retro-reflective marking the coefficient of retro-reflection R' shall be measured in conformity with Annex 7, the sample unit being first lightly shaken to remove excess water from the outside.

**2. Test for Advance warning triangles:**

2.1.1. Test of resistance of the retro-reflecting device or fluorescent retro-reflecting material

1.2.1.1. The triangle - collapsible triangles are to be assembled as for use - shall be immersed for 10 minutes in water having a temperature of  $50\text{ }^{\circ}\text{C} \pm 5\text{ }^{\circ}\text{C}$ , with the highest point of the upper part of the illuminating surface being about 20 mm below the water surface. Immediately afterwards, this retro-reflecting device shall be immersed under the same conditions in water having a temperature of  $25\text{ }^{\circ}\text{C} \pm 5\text{ }^{\circ}\text{C}$ .

1.2.1.2. After this test, no water shall have penetrated to the reflecting surface of the retro-reflecting device. If a visual inspection clearly reveals the presence of water, the device has not passed the test. Water or water vapour penetration into the edges of fluorescent retro-reflecting materials shall not be deemed to indicate failure.

1.2.1.3. If the visual inspection does not reveal the presence of water, or in case of doubt the value of the CIL shall again be measured under the same conditions as specified in **paragraph 1.2.** above, after the retro-reflecting device has been gently shaken to remove excess water from the outside. The CIL shall not have diminished by more than 40 per cent of the values recorded before the test.

1.2.2. Water test

The triangle - collapsible advance warning triangles are to be assembled as for use - shall be immersed flat for two hours on the bottom of a tank containing water at  $25\text{ }^{\circ}\text{C} \pm 5\text{ }^{\circ}\text{C}$ , with the active face of the triangle showing upwards and being 5 cm under the surface of the water. The triangle shall then be removed and dried. No part of the device may exhibit clear signs of deterioration which might impair the effectiveness of the triangle.

## Annex 8

### **Resistance to dirt penetration for retro-reflecting devices of the Classes IB, and IIB.**

1. As an alternative, at the request of the manufacturer, the following test (moisture and dust test) shall be applied.
2. Moisture test

The test evaluates the ability of the sample device to resist moisture penetration from a water spray and determines the drainage capability of those devices with drain holes or other exposed openings in the device.

  - 2.1. Water spray test equipment

A water spray cabinet with the following characteristics shall be used:

    - 2.1.1. Cabinet

The cabinet shall be equipped with a nozzle(s) which provides a solid cone water spray of sufficient angle to completely cover the sample device. The centreline of the nozzle(s) shall be directed downward at an angle of  $45^{\circ} \pm 5^{\circ}$  to the vertical axis of a rotating test platform.
    - 2.1.2. Rotating test platform

The rotating test platform shall have a minimum diameter of 140 mm and rotate about a vertical axis in the centre of the cabinet.
    - 2.1.3. Precipitation rate

The precipitation rate of the water spray at the device shall be 2.5 (+1.6/-0) mm/min as measured with a vertical cylindrical collector centred on the vertical axis of the rotating test platform. The height of the collector shall be 100 mm and the inside diameter shall be a minimum of 140 mm.
  - 2.2. Water spray test procedure

A sample device mounted on a test fixture, with initial CIL measured and recorded shall be subjected to a water spray as follows:

    - 2.2.1. Device openings

All drain holes and other openings shall remain open. Drain wicks, when used, shall be tested in the device.
    - 2.2.2. Rotational speed

The device shall be rotated about its vertical axis at a rate of  $4.0 \pm 0.5 \text{ min}^{-1}$ .
    - 2.2.3. If the retro-reflector is reciprocally incorporated or grouped with signalling or lighting functions, these functions shall be operated at design voltage according to a cycle of 5 min ON (in flashing mode, where appropriate), 55 min OFF.
    - 2.2.4. Test duration

The water spray test shall last 12 hours (12 cycles of 5/55 min).

2.2.5. Drain period

The rotation and the water spray shall be turned OFF and the device allowed to drain for 1 hour with the cabinet door closed.

2.2.6. Sample evaluation

Upon completion of the drain period. The interior of the device shall be observed for moisture accumulation. No standing pool of water shall be allowed to be formed, or which can be formed by tapping or tilting the device. The CIL shall be measured according to the method specified in Annex 4 paragraph 3.2. after having dried the exterior of the device with a dry cotton cloth.

2.3. Dust exposure test

This test evaluates the ability of the sample device to resist dust penetration which could significantly affect the photometric output of the retro-reflector.

2.3.1.. Dust exposure test equipment

The following equipment shall be used to test for dust exposure:

2.3.2. Dust exposure test chamber

The interior of the test chamber shall be cubical in shape in size 0.9 to 1.5 m per side. The bottom may be "hopper shaped" to aid in collecting the dust. The internal chamber volume, not including a "hopper shaped" bottom shall be 2 m<sup>3</sup> maximum and shall be charged with 3 to 5 kg of the test dust. The chamber shall have the capability of agitating the test dust by means of compressed air or blower fans in such a way that the dust is diffused throughout the chamber.

2.3.3. The dust

The test dust used shall be fine powdered cement in accordance with standard ASTM C 150-84.\*

2.3.4. Dust exposure test procedure

A sample device, mounted on a test fixture, with the initial CIL measured and recorded, shall be exposed to dust as follows:

2.3.5. Device openings

All drain holes and other openings shall remain open. Drain wicks, when used, shall be tested in the device.

2.3.6. Dust exposure

The mounted device shall be placed in the dust chamber no closer than 150 mm from a wall. Devices with a length exceeding 600 mm shall be horizontally centred in the test chamber. The test dust shall be agitated as completely as possible by compressed air or blower(s) at intervals of 15 min for a period of 2 to 15 s for the duration of 5 hours. The dust shall be allowed to settle between the agitation periods.

2.3.7. Measured sample evaluation

Upon completion of the dust exposure test, the exterior of the device shall be cleaned and dried with a dry cotton cloth and the CIL measured according to the method specified in Annex 4, paragraph 3.2.

---

\* American Society for Testing and Materials



## Annex 9

### Resistance to fuels

1. test mixture of 70 vol. per cent of n-heptane and 30 vol. per cent of toluol shall be applied for:
2. Either a retro-reflecting devices, the outer surface of the retro-reflecting device and, in particular, of the illuminating surface, shall be lightly wiped with a cotton cloth soaked in the test mixture.  
  
After about five minutes, the surface shall be inspected visually. It must not show any apparent surface changes, except that slight surface cracks will not be objected to.
3. Or a sample unit of retro-reflective marking, a section of a sample unit not less than 300 mm long shall be immersed in the test mixture for one minute.  
After removal, the surface shall be wiped dry with a soft cloth and shall not show any visible change which would reduce its effective performance.
4. Test for **andAdvance warning triangles:**
5. The triangle and its protective cover shall be immersed separately in a tank containing a mixture of 70 per cent n-heptane and 30 per cent toluene. After 60 seconds they shall be removed from the tank and drained of excess liquid. The triangle shall then be placed in its cover and the unit shall be laid flat in a still atmosphere. When completely dried, the triangle shall not adhere to its protective cover, and there shall be no visually noticeable change on its surface and shall not present apparent detrimental modifications; however, slight surface cracks may be tolerated.

## Annex 10

### Resistance to lubricating oils

#### **Test procedure in the case of moulded plastics reflectors as Classes IA, IB, IIIA, IIIB, IVA and Advance warning triangle of type 1**

The outer surface of the retro-reflecting device and, in particular, the illuminating surface, shall be lightly wiped with a cotton cloth soaked in a detergent lubricating oil. After about 5 minutes, the surface shall be cleaned. The CIL shall then be measured (Annex 4, paragraph 3.2. or Annex 14, paragraph 4.2.).

# Annex 11

## Resistance to corrosion (ISO Standard 3768)

1. Retro-reflecting devices must be so designed that they retain the prescribed photometric and colorimetric characteristics despite the humidity and corrosive influences to which they are normally exposed. The resistance of the front surface to tarnishing and of the protection of the rear face to deterioration shall be checked, particularly when an essential metal component seems liable to be attacked.
2. The retro-reflecting device, or the lamp if the device is combined with a light, shall be stripped of all removable parts and subjected to the action of a saline mist for a period of 50 hours, comprising two periods of exposure of 24 hours each, separated by an interval of two hours during which the sample is allowed to dry.
3. The saline mist shall be produced by atomizing, at a temperature of  $35\text{ °C} \pm 2\text{ °C}$ , a saline solution obtained:
  - 3.1. **In the case of moulded plastics reflectors as Classes IA, IB, IIIA, IIIB, IVA and Advance warning triangle of type 1**  
by dissolving  $20 \pm 2$  parts by weight of sodium chloride in 80 parts of distilled water containing not more than 0.02 per cent of impurities.
    - 3.1.1. Immediately after completion of the test, the sample must not show signs of excessive corrosion liable to impair the efficiency of the device.
  - 3.2. **In the case of a sample unit of retro-reflective marking,**  
by dissolving 5 parts by weight of sodium chloride in 95 parts of distilled water containing not more than 0.02 per cent of impurities.
    - 3.2.1. Immediately after completion of the test, the sample shall show no sign of corrosion liable to impair the efficiency of the marking.
4. The coefficient of retro-reflection  $R'$  of the retro-reflective areas, when measured after a recovery period of 48 hours as specified in [paragraph 1 of Annex 7](#) at an entrance angle of  $\beta_2 = 5^\circ$  and an observation angle of  $\alpha = 20'$ , shall be not less than the value in [Annex 7, table 1](#) or more than the value in table 2 respectively. Before measuring, the surface shall be cleaned to remove salt deposits from the saline mist.

## Annex 12

### Resistance of the accessible rear face of mirror-backed retro-reflecting devices

1. Resistance of the accessible rear face of mirror-backed retro-reflecting devices, **in the case of moulded plastics reflectors as Classes IA, IB, IIIA, IIIB, IVA and Advance warning triangle of type 1**
2. The reverse side of the retro-reflecting device shall be brushed with a hard nylon brush.
3. After having brushed **in the case of moulded plastics reflectors as Classes IA, IB, IIIA, IIIB and IVA** the rear face of the retro-reflecting device, a cotton cloth soaked in the mixture, defined in **Annex 9 paragraph 1.1** above shall be applied to the said rear face for one minute. The cotton cloth is then removed and the retro-reflecting device left to dry.
4. After having brushed, **in the case of moulded plastics reflectors of Advance warning triangle of type 1**, the reverse side of the retro-reflecting device shall then covered or thoroughly wetted for one minute with a defined in **Annex 9 paragraph 1.1. above**. The fuel shall then be removed and the device allowed to dry.
5. As soon as evaporation is completed, the reverse side shall be brushed with the same brush as before. .
6. The CIL shall then be **measured (Annex 4, paragraph 3.2. or Annex 14, paragraph 4.2.) after** the whole surface of the mirror-backed rear face has been covered with Indian ink.
7. In the case of the retro-reflector of an **Advance warning triangle of type 1**, the CIL shall not have diminished by more than 40 per cent of the values recorded before the test. This test is not applicable for fluorescent retro-reflecting material.

## Annex 13

### Resistance to weathering

#### Resistance to weathering in the case of a sample units of retro-reflective marking devices

1. Procedure - For each test, two specimens of a sample unit (see paragraph 2.1.4.) are taken. One specimen shall be stored in a dark and dry container for subsequent use as "reference unexposed specimen".
2. The second specimen shall be subjected to a source of illumination with a temperature and irradiation test described in Annex 22, if required in in the relevant paragraph 4:
  - The retro-reflector or retro-reflective material shall be exposed until blue standard No. 7 has has faded to No. 4 on the grey scale blue standard No. 7 .
  - The fluorescent materia or fluorescent / retro-reflective material shall be exposed until blue standard No. 5 has has faded to No. 4 on the grey scale.
3. After the test, the specimen shall be washed in a dilute neutral detergent solution, dried and examined for conformity with the requirements specified in paragraphs 1.2. to 1.4.
4. Visual appearance

No area of the exposed specimen shall show any evidence of cracking, scaling, splitting, blistering, delamination, distortion, chalking, staining or corrosion.

The sample shall not exhibit any visible damage such as cracks, scaling or peeling of the fluorescent or of the fluorescent retro-reflecting material.
- 4.1. Colour fastness - The colours of the exposed specimen shall still meet the requirements specified in the subparagraph 5 of the relevant paragraph 4 for the corresponding retro-reflective device.
- 1.4. Effect on the coefficient of retro-reflection of the retro-reflective material:
  - 1.4.1. For this check, measurements shall be made only at an observation angle of  $\alpha = 20'$  and an entrance angle of  $\beta_2 = 5^\circ$  by the method given in Annex 7.
  - 1.4.2. The coefficient of retro-reflection of the exposed specimen when dry shall be not less than 80 per cent of the value in Annex 7, tables 1 and 2.

## Resistance to weathering in the case of advance warning triangles

1. Test of the weather-resistance of the luminance factor and of the colour of the fluorescent (advance warning triangle of type 1) and fluorescent retro-reflecting (advance warning triangle of type 2) materials.
2. One of the samples of the fluorescent material submitted according to paragraph 3.5. of this Regulation shall be subjected to a temperature and irradiation test described in Annex 9 to until the contrast No. 4 of the grey scale has been reached for the reference sample No. 5 or the light exposure equivalents for blue wool light fastness references sample No. 5 to fade to the grey scale 4 for exposure by a Xenon-arc lamp has been reached.
3. For retro-reflective device with the fluorescent material, after this test, the colour coordinates and the luminance factor (see paragraph 3. above) shall comply with the specification in the subparagraph 5 of the relevant paragraph 4 for the corresponding retro-reflective device.  
The shall comply with paragraph 7.2.2.3. and shall not have increased by more than 5 per cent compared with the value ascertained according to paragraph 1.7.2. above
4. If the fluorescent material is an adhesive film which had already successfully passed the above-mentioned tests in a previous approval test, the test need not be repeated; a corresponding note shall be entered under item 12 ("Remarks") in the communication concerning approval (Annex 1).
5. Test of the weather-resistance of the luminance factor and of the colour of the fluorescent (advance warning triangle of type 1) and fluorescent retro-reflecting (advance warning triangle of type 2) materials.

## Annex 14

### Stability of photometric properties

The approval granting authority has the right to test the optical properties stability of a retro-reflecting material in use (when used for marking or as distinctive markings/graphics).

The Administrative Departments of Contracting Parties, in which the approval was granted, may undertake the same tests. If "systematic failures in use" occur for a type of retro-reflective material, the tested material samples shall be transferred for appraisal to the authority which granted approval.

If other criteria are missing, the notation "systematic failures in use" for a type of retro-reflective material is to be established according to paragraph 6 of this Regulation.

The authority which granted approval shall have the right to check the stability in time of the optical properties of a type of rear marking plate in service.

The Competent Authorities of countries other than the country in which approval was granted may carry out similar checks in their territory. If a type of rear marking plate in use exhibits a systematic defect, the said authorities shall transmit to the authority which granted approval, with a request for its opinion, any components removed for examination.

In the absence of other criteria, the concept of "systematic defect" of a type of rear marking plate in use shall be interpreted in conformity with the intention of **paragraph 6.1.**

## Annex 15

### **Resistance to cleaning in the case of a sample units of retro-reflective marking devices:**

#### **Manual cleaning**

A test sample smeared with a mixture of detergent lubricating oil and graphite shall be easily cleaned without damage to the retro-reflective surface when wiped with a mild aliphatic solvent such as n-heptane, followed by washing with a neutral detergent.

#### **Power washing**

When subjected to a continuous spraying action for 60 seconds on the test component in its normal mounting conditions, a test sample shall show no damage to the retro-reflective surface or delamination from the substrate or separation from the sample mounting surface under the following set-up parameters:

- (a) Water/wash solution pressure  $8 \pm 0.2$  MPa;
- (b) Water/wash solution temperature  $60^{\circ} - 5$  °C;
- (c) Water/wash solution flow rate  $7 \pm 1$  l/min;
- (d) The tip of the cleaning wand to be positioned at distance of  $600 \pm 20$  mm away from the retro-reflective surface;
- (e) Cleaning wand to be held at no greater angle than 45 degrees from perpendicular to the retro-reflective surface;
- (f) 40 degree nozzle creating wide fan pattern.



## Annex 16

### **Bonding strength**

#### **Bonding strength (in the case of adhesive materials) for Retro-reflecting Markings**

The adhesion of retro-reflective materials shall be determined after 24 hours curing time by utilising a 90 degree peel on a tensile strength testing machine.

The retro-reflective materials shall not be easily removable without damaging the material.

The retro-reflective materials shall need a force of at least 10 N per 25 mm width at a constant speed of 300 mm per minute to be removed from their substrate.

#### **Bonding strength (in the case of adhesive materials) for Retro-reflective Material for Rear Marking Plates**

The adhesion of retro-reflective materials shall be determined after 24 hours curing time by utilizing a 90-degree peel on a tensile strength testing machine.

The adhesion of laminated or coated retro-reflective and fluorescent materials shall be determined.

The coated materials, of whatever kind, shall not be removable without tools or without damaging the material.

The laminated materials (adhesive films) shall need a force of at least 10 N per 25 mm width, at a speed of 300 mm per minute, to be removed from the substrate.

## Annex 17

### Flexing

#### Retro-reflecting Markings

For samples that are to be adhered to a flexible substrate, i.e. tarpaulin, the following shall apply:

A specimen of the sample unit that measures 50 mm by 300 mm shall be bent once lengthwise, around a 3.2 mm mandrel with adhesive contacting the mandrel for a period of 1 second.

The test temperature shall be  $23\text{ °C} \pm 2\text{ °C}$ .

Note: For ease of testing, spread talcum powder on the adhesive to prevent sticking to the mandrel.

After this test, specimen shall not have cracking of the surface and shall not show any visible change that would reduce its effective performance.

## Annex 18

### Resistance to impact

#### **Rear Marking Plates** (except for plastics corner-cube reflectors)

When a 25 mm diameter solid steel ball is dropped from a height of 2 m onto the retro-reflective and fluorescent surfaces of a supported plate, at an ambient temperature of  $23 \pm 2^{\circ}\text{C}$ , the material shall show no cracking or separation from the substrate at a distance of more than 5 mm from the impacted area.

#### **Retro-reflecting devices of the Classe IVA**

The retro-reflecting device shall be mounted in a manner similar to the way in which it is mounted on the vehicle, but with the lens faced horizontal and directed upwards.

Drop a 13 mm diameter polished solid steel ball, once, vertically onto the central part of the lens from a height of 0.76 m. The ball may be guided but not restricted in free fall.

When a retro-reflecting device is tested at room temperature with this method, the lens shall not crack.

## Annex 19

### **Rigidity of plates of the Classes 1, 2, 3, 4 and 5**

The rear marking plate shall be placed on two supports in such a way that the supports are parallel to the shorter edge of the plate and the distance from either support to the adjacent edge of the plate shall not exceed  $L/10$ , where  $L$  is the greater overall dimension of the plate. The plate shall then be loaded with bags of shot or of dry sand to a uniformly distributed pressure of  $1.5 \text{ kN/m}^2$ . The deflection of the plate shall be measured at a point midway between the supports.

When tested as described in paragraph 1. above, the maximum deflection of the plate under the test load shall not exceed one twentieth of the distance between the supports in paragraph 1. and the residual deflection after removal of the load shall not exceed one fifth of the measured deflection under load.

### **Rigidity of plates of the Class SMV**

The triangular plate shall be strongly held on one of its long sides, with the clamps of the holding device not encroaching over more than 20 mm. A force of 10N perpendicular to the plane shall be applied to the opposite apex.

The apex shall then not move in the direction of the force by more than 40 mm.

After removal of the force, the plate shall visibly return to its initial position. The residual deflection shall not be more than 5 mm.

## Annex 20

### Further test procedures for Advance Warning Triangles of Type 1 and 2

#### 1. Test of clearance to ground

- 1.1. The advance warning triangle shall be required to pass the following tests:
  - 1.1.1. For this test, the apparatus shown in Annex 3, Figure 2, which has the form of an inverted hollow pyramid, shall be placed on a horizontal base plane.
  - 1.1.2. The individual supports to the ground shall be placed one after another in the square hole  $\sigma$  of the test apparatus. During the test of each support, it shall be required to find a position of the test apparatus in relation to the advance warning triangle and its supporting device, which is favourable for the triangle and which ensures that:
    - 1.1.2.1. All supports are resting simultaneously on the base plane,
    - 1.1.2.2. Outside the area covered by the test apparatus, the distance between the base plane and parts of the triangle as well as of the supporting device is at least 50 mm (with the exception of the supports proper).

#### 2. Mechanical solidity test

- 2.1. When the advance warning triangle has been set up as required by the manufacturer and its bases are firmly held, a force of 2 N shall be applied to the apex of the triangle parallel to the supporting surface and normal to the lower side of the triangle.
- 2.2. The apex of the triangle shall not move more than 5 cm in the direction in which the force is exerted.
- 2.3. After the test, the position of the device shall not be significantly different from its original position.

#### 3. Test of heat and low-temperature resistance

- 3.1. The advance warning triangle, in its protective cover, if provided, shall be kept for 12 consecutive hours in a dry atmosphere at a temperature of  $60\text{ }^{\circ}\text{C} \pm 2\text{ }^{\circ}\text{C}$ .
- 3.2. After the test, no cracking or noticeable distortion of the device shall be visible; this applies in particular to the retro-reflecting device. The cover shall be readily openable and shall not adhere to the triangle.
- 3.3. After the heat-resistance test and subsequent storage for 12 consecutive hours at a temperature of  $25\text{ }^{\circ}\text{C} \pm 5\text{ }^{\circ}\text{C}$ , the advance warning triangle, in its protective cover, is to be kept for another 12 hours in a dry atmosphere at a temperature of  $-40\text{ }^{\circ}\text{C} \pm 2\text{ }^{\circ}\text{C}$ .

- 3.4. Immediately after removal from the cold room, no fractures or any visible distortion shall be noticeable on the device and especially on its optical parts. The protective cover, if provided, shall be properly openable, and it shall neither tear nor adhere to the advance warning triangle.

#### **4. Test of stability against wind**

- 4.1. The advance warning triangle shall be set up in a wind tunnel, on a base measuring about 1.50 m by 1.20 m with a surface formed of abrasive material of the type P36 corresponding to the FEPA<sup>3</sup> specification 43-1-2006. This surface shall be characterised by its geometric roughness,  $HS = 0.5 \text{ mm} \pm 0.05 \text{ mm}$ , which shall be defined and determined by the so-called "sandy beach" method according to Annex 4 of this Regulation.

To avoid a laminar boundary layer of the incident flow over the surface of the base, this base shall have a splitter plate and shall be set up in such a way, that the flow is completely around the plate.

- 4.2. For the air flow the following conditions shall apply:
- (a) The air stream shall reach a dynamic pressure of 180 Pa; and shall have a flow field which shall be homogeneous and free of turbulence;
  - (b) The dimension of the flow field shall be such, that horizontally to each corner and vertical to the top of the advance warning triangle a clearance of at least 150 mm to the border line of this flow field shall exist;
  - (c) The air stream (flow field) shall be parallel to the supporting surface, in a direction which seems to be most unfavourable for the stability;
  - (d) In the case of a closed wind tunnel, the area of the advance warning triangle shall be not larger than 5 per cent of the area cross-section of the closed wind tunnel.
- 4.3. When set up in this manner, the advance warning triangle shall be subjected for 3 minutes to this open air stream.
- 4.4. The advance warning triangle shall neither overturn nor shift. Slight shifting of the points of contact with the road surface by not more than 5 cm, however, shall be allowed.
- 4.5. The retro-reflecting triangular part of the device shall not rotate through more than  $10^\circ$  round a horizontal axis or a vertical axis from its initial position. The rotation around the horizontal axis or the vertical axis shall be determined by the aid of a virtual plane at the initial position of the retro-reflecting triangular part of the device, which is orthogonal to the base and orthogonal to the air stream.

---

<sup>3</sup> FEPA: Federation of European Producers of Abrasives, 20 Avenue Reille, 75014 Paris, France.

5. Test of the weather-resistance of the luminance factor and of the colour of the fluorescent (advance warning triangle of type 1) and fluorescent retro-reflecting (advance warning triangle of type 2) materials.
  - 5.1. One of the samples of the fluorescent material submitted according to paragraph 3.5. of this Regulation shall be subjected to a temperature and irradiation test described in Annex 9 to this Regulation until the contrast No. 4 of the grey scale has been reached for the reference sample No. 5 or the light exposure equivalents for blue wool light fastness references sample No. 5 to fade to the grey scale 4 for exposure by a Xenon-arc lamp has been reached.
  - 5.2. After this test, the colour co-ordinates of the fluorescent material shall comply with colour specification in paragraph 7.2.2.2. of this Regulation. The luminance factor (see paragraph 3. above) shall comply with paragraph 7.2.2.3. of this Regulation and shall not have increased by more than 5 per cent compared with the value ascertained according to paragraph 1.7.2. above
  - 5.3. The sample shall not exhibit any visible damage such as cracks, scaling or peeling of the fluorescent or of the fluorescent retro-reflecting material.
  - 5.4. If the fluorescent material is an adhesive film which had already successfully passed the above-mentioned tests in a previous approval test, the test need not be repeated; a corresponding note shall be entered under item 12 ("Remarks") in the communication concerning approval (Annex 1 to this Regulation).
-

## Annex 21

### **Colour-fastness<sup>4</sup> of retro-reflecting devices of the Classes IA, IB, IIIA, IIIB and IVA**

1. The Type Approval Authority which granted approval shall have the right to check the colour-fastness of a type of retro-reflecting device in service.
2. The competent authorities of countries other than the country in which approval was granted may carry out similar checks in their territory. If a type of retro-reflector in use exhibits a systematic defect, the said authorities shall transmit any components removed for examination to the Type Approval Authority which granted approval, with a request for its opinion.
3. In the absence of other criteria, the concept "systematic defect" of a type of retro-reflector in use shall be interpreted in conformity with the intention of paragraph 9.1. of this Regulation.

---

<sup>4</sup> Despite the importance of tests to check the colour-fastness of retro-reflecting devices, it is in the present state of the art not yet possible to assess colour-fastness by laboratory tests of limited duration.



## Annex 22

### Colour fastness to artificial light - Xenon-arc lamp test

#### 1. Scope

This annex specifies a method intended for determining the resistance of the colour of test samples of all kinds and in all forms to the action of an artificial light source representative of natural daylight (D65).

#### 2. Principle

A specimen of the test samples to be tested is exposed to artificial light under prescribed conditions, along with a blue wool reference as specified.

#### 3. Reference materials

The colour fastness ratings mentioned in this annex are obtained by comparison unexposed with exposed specified blue wool references for verification of the radiation dose as a required maximum contrast **in the pertinent Regulation.**

- 3.1. Blue wool references developed and produced in Europe are identified by the numerical designation 1 to 8. These references are blue wool cloths dyed with the dyes listed in table 1. For the **test procedure of the pertinent Regulation,** described by this annex only the blue wool references 5 and 7 will be applied as described in Table 1 below.

Table 1 : **Dyes for blue wool references 5 and 7**

<i>Reference</i>	<i>Dye (Colour Index designation)<sup>1</sup></i>
5	CI Acid Blue 47
7	CI Solubilised Vat Blue 5

<sup>1</sup> The Colour Index (third edition) is published by The Society of Dyers and Colourists, P.O. Box 244, Perkin House, 82 Grattan Road, Bradford BD1 2JB, UK, and by The American Association of Textile Chemists and Colorists, P.O. Box 12215, Research Triangle Park, NC 27709-2215, USA.

#### 4. Grey scale

The grey scale for determining changes in colour of test samples in colour fastness tests. A precise colorimetric specification of the scale is given in Appendix 1 to this annex.

- 4.1. The use of the scale is described in paragraph 2 of Appendix 1 to this annex.

## 5. Xenon-arc lamp apparatus

The apparatus shall be either an air-cooled or water-cooled Xenon-arc weathering device capable of exposing samples in accordance with EN ISO 4892-2.

- 5.1. The exposure conditions shall comply with the requirements in the Table 2 below.

Table 2 : Artificial weathering test parameters

<i>Exposure parameters</i>	<i>Air-cooled lamp</i>	<i>Water-cooled lamp</i>
Light/dark/water spray cycle	Continuous light without water spray	Continuous light without water spray
Black standard temperature during light only periods	(47 ± 3) °C using a black standard thermometer	(47 ± 3) °C using a black standard thermometer
Relative humidity	Approximately 40 %	Approximately 40 %
Filters	Window glass filters requirements see paragraph 5.2.	Window glass filters requirements see paragraph 5.2.
<i>Irradiance (W/m<sup>2</sup>) controlled at:</i>		
Over 300nm to 400nm range	42±2	42±2
Over 300nm to 800nm range	550	630
<p><i>Note 1:</i> Water used for the specimen spray should contain no more than 1 ppm silica. Higher levels of silica can produce spotting on samples and variability in results. Water of the required purity can be obtained by distillation or by a combination of deionization and reverse osmosis.</p> <p><i>Note 2:</i> While irradiance levels should be set at the above levels, variations in filter ages and transmissivity, and in calibration variations, will generally mean that irradiance error will be in the order of ± 10 per cent.</p>		

### 5.2 Light source

The light source shall consist of a xenon arc lamp of correlated colour temperature 5500 K to 6500 K, the size of which will depend on the type of apparatus used. The xenon-arc lamp shall use filters that provide a reasonable simulation of solar radiation filtered by typical window glass. Table 3 gives the relative spectral irradiance requirements for the filtered xenon-arc. It is the responsibility of the supplier of the exposure device to provide necessary certification that the filters that they supply for use in the exposure tests described in this standard meets the requirements of Table 3.

Table 3 : **Relative spectral irradiance requirements for window glass filters** <sup>a, b, c, d, e</sup>  
**used for the Xenon-arc devices used in this standard.**

<i>Spectral Bandpass Wavelength <math>\lambda</math> in nm</i>	<i>Minimum %<sup>c</sup></i>	<i>CIE No.85, Table 4 plus window glass %<sup>d, e</sup></i>	<i>Maximum %<sup>c</sup></i>
1 < 300			0.29
300 ≤ $\lambda$ ≤ 320	0.1	≤1	2.8
320 < $\lambda$ ≤ 360	23.8	33.1	35.5
360 < $\lambda$ ≤ 400	62.4	66.0	76.2

<sup>a</sup> Data in Table 3 is the irradiance in the given bandpass expressed as a percentage of the total irradiance from 290 nm to 400 nm. To determine whether a specific filter or set of filters for a xenon-arc meets the requirements of Table 3, the spectral irradiance from 250 nm to 400 nm must be measured. The total irradiance in each wavelength bandpass is then summed and divided by the total irradiance from 290 nm to 400 nm.

<sup>b</sup> The minimum and maximum data in Table 3 are based on more than 30 spectral irradiance measurements for water and air cooled xenon-arcs with window glass filters of various lots and ages. Spectral irradiance data is for filters and xenon-burners within the ageing recommendations of the device manufacturer. As more spectral irradiance data become available, minor changes in the limits are possible. The minimum and maximum data are at least the three sigma limits from the mean for all measurements.

<sup>c</sup> The minimum and maximum columns will not necessarily sum to 100 per cent because they represent the minimum and maximum for the data used. For any individual spectral irradiance, the calculated percentage for the bandpasses in Table 3 will sum to 100 per cent. For any individual xenon-arc lamp with window glass filters, the calculated percentage in each bandpass must fall within the minimum and maximum limits of Table 2. Test results can be expected to differ between exposures using xenon-arc devices in which the spectral irradiance differ by as much as that allowed by the tolerances. Contact the manufacturer of the xenon-arc devices for specific spectral irradiance data for the xenon-arc and filters used.

<sup>d</sup> The data from Table 4 in CIE No. 85 [1] plus window glass was determined by multiplying the CIE No. 85, Table 4 data by the spectral transmittance of 3 mm thick window glass (see ISO 11341 [2]). These data are target values for xenon-arc with window glass filters.

<sup>e</sup> For the CIE 85 Table 4 plus window glass, the UV irradiance from 300 nm to 400 nm is typically about 9 per cent and the visible irradiance (400 nm to 800 nm) is typically about 91 per cent when expressed as a percentage of the total irradiance from 300 nm to 800 nm. The percentages of UV and visible irradiances on samples exposed in xenon arc devices may vary due to the number and reflectance properties of specimens being exposed.

5.3. Light exposure equivalents for blue wool light fastness references for exposure by a Xenon-arc lamp

Table 4 : **Blue wool reference**

<i>Blue wool reference</i>		<i>420nm</i>	<i>300 nm–400 nm</i>
No.		<i>kJ/m<sup>2</sup></i>	<i>kJ/m<sup>2</sup></i>
5	L6	340	13824
7	L8	1360	55296
For colour change of step 4 on the grey scale			

## **6. Procedure (blue wool references)**

- 6.1 Place the test samples mounted on the holders in the apparatus and expose them continuously to weathering following the method described below.
- 6.2 At the same time expose the blue wool references mounted on card-board, cover one-third of each.
- 6.3 Only one side of the test samples shall be exposed to weathering and light.
- 6.4 While the specimens are drying, the air in the test chamber shall not be moistened.  
*Note:* The actual conditions of the weathering test depend on the kind of test apparatus used.
- 6.5. Before mounting the tested specimens for assessment, dry them in air at a temperature not exceeding 60°C.
- 6.6. Trim and mount the exposed blue wool reference so that they measure at least 15 mm x 30 mm, one on each side of a portion of the original which has been trimmed to the same size and shape as the specimens.
- 6.7. Unexposed samples of original fabric identical to those being tested are required as references for comparison with the specimens during weathering.

## Annex 22 - Appendix 1

### Definition of the Grey Scale

This section describes the grey scale for determining changes in colour of test samples in colour fastness tests, and its use. A precise colorimetric specification of the scale is given as a permanent record against which newly prepared working standards and standards that may have changed can be compared.

1. The essential, or 5-step, scale consists of five pairs of non-glossy grey colour chips (or swatches of grey cloth), which illustrate the perceived colour differences corresponding to fastness ratings 5, 4, 3, 2 and 1. This essential scale may be augmented by the provision of similar chips or swatches illustrating the perceived colour differences corresponding to the half-step fastness ratings 4-5, 3-4, 2-3 and 1-2, such scales being termed 9-step scales. The first member of each pair is neutral grey in colour and the second member of the pair illustrating fastness rating 5 is identical with the first member. The second members of the remaining pairs are increasingly lighter in colour so that each pair illustrates increasing contrasts or perceived colour differences which are defined colorimetrically. The full colorimetric specification is given below:
  - 1.1. The chips or swatches shall be neutral grey in colour and shall be measured with a spectrophotometer with the specular component included. The colorimetric data shall be calculated using CIE standard colorimetric system for Illuminant D65;
  - 1.2. The Y tristimulus value of the first member of each pair shall be  $12 \pm 1$ ;
  - 1.3. The second member of each pair shall be such that the colour difference between it and the adjacent first member is as follows.

Table 1  
**CIELab difference in relation to the Fastness grade**

<i>Fastness grade</i>	<i>CIELab difference</i>	<i>Tolerance</i>
5	0	0.2
(4-5)	0.8	±0.2
4	1.7	±0.3
(3-4)	2.5	± 0.35
3	3,4	±0.4
(2-3)	4.8	±0.5
2	6.8	±0.6
(1-2)	9.6	±0.7
1	13.6	±1.0

*Note 1:* Bracketed values apply only to the 9-step scale.

*Note 2:* Use of the scale:

Place a piece of the original blue reference and the exposed specimen of it side by side in the same plane and oriented in the same direction. Place the grey scale nearby in the same plane. The surrounding field should be neutral grey colour approximately midway between that illustrating grade 1 and that illustrating grade 2 of the grey scale for assessing change in colour (this is approximately Munsell N5). Illuminate the surfaces with north sky light in the Northern hemisphere, south sky light in the Southern hemisphere, or an equivalent source with an illumination of 600 lx or more. The light should be incident upon the surfaces at approximately 45°, and the direction of viewing approximately perpendicular to the plane of the surfaces. Compare the visual difference between original and exposed blue standard with the differences represented by the grey scale.

If the 5-step scale is used, the fastness rating of the specimen is that number of the grey scale which has a perceived colour difference equal in magnitude to the perceived colour difference between the original and the treated specimens; if the latter is judged to be nearer the imaginary contrast lying midway between two adjacent pairs than it is to either, the specimen is given an intermediate assessment, for example 4-5 or 2-3. A rating of 5 is given only when there is no perceived difference between the tested specimen and the original material.

If the 9-step scale is used, the fastness rating of the specimen is that number of the grey scale which has a perceived colour difference nearest in magnitude to the perceived colour difference between the original and the tested specimens. A rating of 5 is given only when there is no perceived difference between the tested specimen and the original material.

## Annex 23

### Description of the measurement geometry for measurement of the colour and the luminance factor of fluorescent retro-reflective materials

Micro-prismatic materials show the phenomenon of "flares" or "sparkles" (Note 1), which might influence the measured results unless special precautions are taken. A reference method, using the wider apertures of the CIE 45°a:0° (or 0°:45°a) geometry is introduced in paragraph 12. of Annex 5 to this Regulation.

Ideally, the measurements shall be made using the CIE 45°a:0° (or 0°:45°a), called the forty-five annular / normal geometry (or the normal/ forty-five annular geometry) defined in CIE 15 (see paragraph 12. of Annex 5.) The measurement area shall be minimum 4.0 cm<sup>2</sup>.

For this geometry CIE 15 recommends that:

- (a) The sampling aperture be irradiated uniformly from all directions between two circular cones with their axes normal to the sampling aperture and apices at the centre of the sampling aperture, the smaller of the cones having a half angle of 40° and the larger of 50° ;
- (b) The receiver uniformly collects and evaluates all radiation reflected within a cone with its axis on the normal to the sampling aperture, apex at the centre of the sampling aperture, and a half angle of 5°.

The annular geometry can be approximated by the use of a number of light sources in a ring or a number of fibre bundles illuminated by a single source and terminated in a ring to obtain the CIE 45°c:0° (circumferential / normal geometry) (Note 2, Note 3).

An alternative manner of approximation is to use a single light source, but rotate the sample during measurement with a rotational speed that ensures that a number of revolutions takes place during the exposure time interval for a measurement so that all wavelengths are given equal weight (Note 2, Note 3).

In addition, the apertures of the light source and the receiver shall have sufficient dimensions in proportion to distances to ensure a reasonable compliance with the above-mentioned recommendations.

*Note 1:* "Flares" or "sparkles" are caused by characteristic paths of rays that enter and leave the sheeting surface at different angles. A characteristic path will dominate by raising the luminance factor value significantly and possibly distorting the chromaticity co-ordinates if it is included within narrow beams of illumination and measurement. However, the average contribution to the daylight reflection is normally small.

*Note 2:* In practice the recommendations can be approximated only. The important issue is that the annular principle is applied and that illumination and collection occur in directions forming fairly large solid angles, as this will reduce the influence of the above-mentioned "sparkles" of micro-prismatic materials and of other variations with the precise geometry shown by some of these materials.

*Note 3:* In spite of such precautions, the practical difficulties of establishing the annular geometry in accordance with the recommendations introduce uncertainty of measurement.

## Annex 24

### Examples of approval marks

Figure 1  
Marking for single lamps

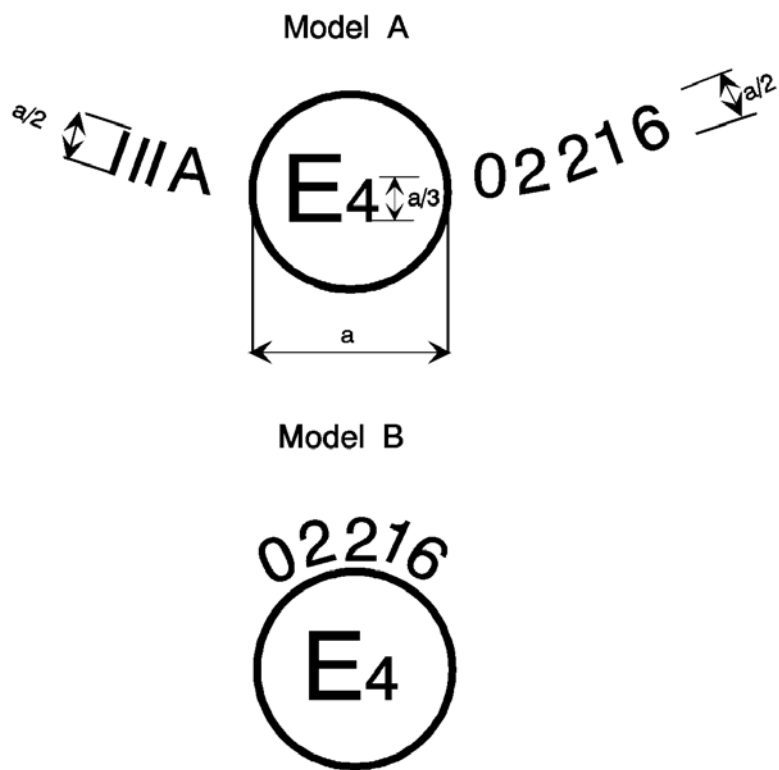

$a = 4 \text{ mm min.}$





a = 4 mm min

*Note:* The above approval number must be placed close to, but in any position in relation to, the circle surrounding the letter "E". The digits constituting the approval number must face the same way as the "E". The group of symbols indicating the class must be diametrically opposite the approval number. The Type Approval Authorities shall avoid using approval numbers IA, IB, IIIA, IIIB and IVA which might be confused with the class symbols IA, IB, IIIA, IIIB and IVA.

These sketches show various possible arrangements and are given as examples only.

The above approval mark affixed to a retro-reflecting device shows that the type of device concerned has been approved in the Netherlands (E 4) under approval number 02216. The approval number shows that approval was granted in accordance with the requirements of the Regulation as modified by the 02 series of amendments.

Figure 2  
 Simplified marking for grouped, combined or reciprocally incorporated lamps

**Model D**

	3333 	IA 02	2a 00	R 01
		F 00	AR 00	S2 01

**Model E**

	IA 2a R 02 00 01 F AR S2 00 00 01 3333 		

**Model F**

<table border="1" style="margin: auto;"> <tr> <td style="text-align: center;">IA 02</td> <td style="text-align: center;">2a 00</td> <td style="text-align: center;">R 01</td> </tr> <tr> <td style="text-align: center;">F 00</td> <td style="text-align: center;">AR 00</td> <td style="text-align: center;">S2 01</td> </tr> </table>	IA 02	2a 00	R 01	F 00	AR 00	S2 01			
IA 02	2a 00	R 01							
F 00	AR 00	S2 01							
3333 									

*Note:* The three examples of approval marks, models D, E and F, represent three possible variants of the marking of a lighting device when two or more lamps are part of the same unit of grouped, combined or reciprocally incorporated lamps. This approval mark shows that the device was approved in the Netherlands (E 4) under approval number 3333 and comprising:

A retro-reflector of Class IA approved in accordance with the 02 series of amendments to Regulation No. 3;

A rear direction indicator of category 2a approved in accordance with Regulation No. 6 in its original form;

A red rear position lamp (R) approved in accordance with the 01 series of amendments to Regulation No. 7;

A rear fog lamp (F) approved in accordance with Regulation No. 38 in its original form;

A reversing lamp (AR) approved in accordance with Regulation No. 23 in its original form;

A stop lamp with two levels of illumination (S2) approved in accordance with the 01 series of amendments to Regulation No. 7.

---