

JRC TECHNICAL REPORTS

JRC exploratory research: Safer Li-ion batteries by preventing thermal propagation

Workshop report:
summary & outcomes
(JRC Petten, Netherlands,
8-9 March 2018)

Vanesa Ruiz and Andreas Pfrang

2018



This publication is a Technical report by the Joint Research Centre (JRC), the European Commission's science and knowledge service. It aims to provide evidence-based scientific support to the European policymaking process. The scientific output expressed does not imply a policy position of the European Commission. Neither the European Commission nor any person acting on behalf of the Commission is responsible for the use that might be made of this publication.

Contact information

Name: Andreas Pfrang
Address: European Commission, Joint Research Centre, Westerduinweg 3, NL-1755 LE Petten/Netherlands
Email: andreas.pfrang@ec.europa.eu
Tel.: +31 (0) 224 56 5047

EU Science Hub

<https://ec.europa.eu/jrc>

JRC113320

EUR 29384 EN

PDF	ISBN 978-92-79-96399-5	ISSN 1831-9424	doi:10.2760/096975
Print	ISBN 978-92-79-96565-4	ISSN 1018-5593	doi:10.2760/786907

Luxembourg: Publications Office of the European Union, 2018

© European Union, 2018

The reuse policy of the European Commission is implemented by Commission Decision 2011/833/EU of 12 December 2011 on the reuse of Commission documents (OJ L 330, 14.12.2011, p. 39). Reuse is authorised, provided the source of the document is acknowledged and its original meaning or message is not distorted. The European Commission shall not be liable for any consequence stemming from the reuse. For any use or reproduction of photos or other material that is not owned by the EU, permission must be sought directly from the copyright holders.

All content © European Union, 2018

How to cite this report: Vanesa Ruiz and Andreas Pfrang, *JRC exploratory research: Safer Li-ion batteries by preventing thermal propagation - Workshop report: summary & outcomes (JRC Petten, Netherlands, 8-9, March 2018)*, EUR 29384 EN, Publications Office of the European Union, Luxembourg, 2018, ISBN 978-92-79-96399-5, doi:10.2760/096975, JRC113320

Printed in Italy

Contents

Acknowledgements	1
Abstract	2
Foreword	3
Problem statement	4
Session 1. Thermal runaway: mechanisms and influencing factors	6
1.1. Factors influencing occurrence and extent of thermal runaway	10
1.1.1. State of charge (SOC)	10
1.1.2. State of health (SOH)	10
1.1.3. C-rate	11
1.1.4. End of charge voltage limit	11
1.1.5. Active cathode material	11
1.2. Chemical hazards and related considerations	12
1.2.1. Hydrofluoric acid (HF) and other fluorides	12
1.2.2. Cathode active material	12
1.2.3. Flammability and oxygen availability	13
1.2.4. Firefighting considerations	13
Session 2. Thermal Propagation	15
2.1. Factors influencing thermal propagation	15
2.1.1. Cell type and cell to cell electrical connections	16
2.1.2. Active cathode material	16
2.1.3. State of charge	16
2.1.4. Thermal runaway initiation method	17
2.2. Simulation and modelling of thermal propagation	17
Session 3. Thermal runaway initiation methods, fit-for-purpose testing related to external and internal abuse triggers	20
3.1. External triggering methods	20
3.1.1. Mechanical initiation methods	20
3.1.2. Electrical initiation methods	21
3.1.3. Thermal initiation methods	22
3.2. Internal triggering methods	23
Session 4. Safety strategies; methods for detecting, mitigating and preventing thermal propagation; anti-cascading strategies	26
Session 5. Cost and performance penalty of mitigating thermal propagation	31
Session 6. Impact of avoiding thermal propagation on the current safety testing landscape	33
Conclusions and recommendations	34
References	37

List of abbreviations and definitions	48
List of figures	41
List of tables	52
Annexes	53
Annex 1. Programme	53
Annex 2. List of participants.....	57

Acknowledgements

The authors of this report would like to thank the speakers for their presentations; the chairmen, and the rapporteurs for their contributions. Also authors would like to acknowledge all the participants for their active participation during the workshop.

Support through the Joint Research Centre's Exploratory Research Program is acknowledged as well as Robert Houghton's contribution in preparing the illustrations of this report.

Finally, authors thank the reviewers of the report for their excellent support: Andrej Golubkov, Harry Döring, Fredrik Larsson and Sebastian Scharner. Also special thanks go to Marc Steen for his helpful comments and suggestions.

Abstract

The Joint Research Centre (JRC) of the European Commission organised a workshop under the umbrella of its *Exploratory Research Programme*¹. The Workshop titled: 'Safer Li-ion batteries by preventing thermal propagation?' was held at the Directorate C-Energy, Transport and Climate in Petten on 8-9 March 2018. The workshop offered a platform where leading experts exchanged ideas and research efforts on thermal propagation testing, new methodologies, policy and standardisation issues and brainstormed on the potential impact of preventing thermal propagation on the safety testing landscape. The input of some of the major stakeholders from industry and research to this event proved very participative on the relevant technical issues discussed, and on the identification of improvements of existing testing methodologies and mitigation strategies. This technical report presents a summary of the main discussion points, conclusions and outcomes of the workshop as agreed by their presenters.

¹ To be developed as one of the pillars of JRC's work, see JRC Strategy 2030, 2016, https://ec.europa.eu/jrc/sites/jrcsh/files/jrc-strategy-2030_en.pdf

Foreword

The intention of this 2 day workshop 'Safer Li-ion batteries by preventing thermal propagation?' was to bring together leading experts not only to discuss the current state-of-the-art of thermal propagation testing, but also to brain-storm on the potential impact of preventing thermal propagation on the safety testing landscape.

The workshop was conceptualised by the organisers (Vanesa Ruiz and Andreas Pfrang) both in terms of defining the content of the sessions and contacting the experts.

The workshop was structured in the following technical sessions:

- Session 1.** Thermal runaway: mechanisms and influencing factors
- Session 2.** Thermal propagation
- Session 3.** Thermal runaway initiation methods, fit-for-purpose testing related to external and internal abuse triggers
- Session 4.** Safety strategies; methods for detecting, mitigating and preventing thermal propagation; anti-cascading strategies
- Session 5.** Cost and performance penalty of mitigating thermal propagation
- Session 6.** Impact of avoiding thermal propagation on the current safety testing landscape

At the end of each session, moderated discussions led by the chairmen of each session took place. Rapporteurs prepared a summary of each session and gave support to the chairmen who presented a summary of their allocated session during the conclusions session.

Workshop participants benefited from the extended experience of known leading scientists, battery design engineers and safety testing experts. Active discussions took place from the interactive group gathered in the workshop. Participants were invited to share knowledge, information and experience.

The discussions and conclusions of the workshop are summarised in this report which will be publicly disseminated to interested stakeholders.

The presentations of the workshop are available online and can be downloaded from:

<https://ec.europa.eu/jrc/en/event/workshop/workshop-safer-li-ion-batteries-preventing-thermal-propagation>

Problem statement

Electrical energy storage plays a crucial role in ensuring mobility and reliable energy supply in the future. Within this context, the 'Communication on Accelerating Clean Energy Innovation' released by the European Commission identifies safer and higher-performing batteries as key requirements for a shift towards full electro-mobility and increased energy storage capacities in homes [1].

Li-ion technology is considered as one of the solutions for large scale applications (e.g. electrification of transport, smart grids) as well as for small scale applications (e.g. portable devices). As we move from single cells to modules and packs (from a few Ah up to several hundreds of Ah), failure modes in Li-ion batteries (LIBs) become increasingly complex and their potential damage can be substantial (e.g. vehicle burn down) and difficult to deal with. Failure modes due to thermal, mechanical or electrical abuse may develop into thermal runaway (TR) [2].

Li-ion cells can be operated safely within a limited window of parameters (e.g. temperature, voltage, charging and discharging currents). Crossing these limits typically leads to a higher cell temperature that once a certain onset temperature is exceeded rapidly rises, leading to thermal runaway which is accompanied by hazardous effects (e.g. pressure increase, gas and particulate emission, fire or even explosion). Thermal runaway occurs when the heat generated by internal cell failure, abuse or misuse cannot be dissipated fast enough [3]. Cascading of TR through an entire battery (which can be composed of numerous electrochemical cells, typically from several dozen to several thousand), defined as thermal propagation (TP), can lead to severe consequences: large heat/gas release (roughly a few 100 kJ/Ah and few l/Ah, respectively [4, 5]), associated hazardous events (e.g. emission of toxic materials [5, 6], pressure build-up and release, electrolyte leakage, fire, explosion) and financial losses (e.g. property damage).

Risks associated with simultaneous thermal runaways in multiple cells occurring under non-normal operating conditions (e.g. energetic collisions, external fire exposure) can be mitigated by battery design. However, the case of a spontaneous single cell thermal runaway reaction, under otherwise normal operating conditions, can be more hazardous as it might happen without warning, without an obvious cause and after a considerable service time (i.e. field failures as identified in references [7, 8]). The fact that cells involved in field failures generally have passed the testing required by safety standards indicates that these events require a special attention [7]. These failures, which have been attributed to cell manufacturing contaminants or cell flaws, are not common and are difficult to detect, despite extensive efforts carried out by battery manufacturers.

There can be two approaches which may be considered to tackle this situation; one is the development of battery chemistries and/or battery designs that do not result in critical events, while a second approach is to assume that a TR may eventually occur, and to implement safety features that focus on detecting and suppressing cell-to-cell or module-to-module propagation. Reliable prevention measures of thermal propagation could potentially result in reduced battery weight, improved performance and ultimately reduced cost at sufficient level of safety.

TR testing is covered by numerous research articles [9-14], and it is required in a few standards [15-19]. Also a number of standards cover thermal propagation testing dealing with various battery applications (e.g. electric vehicles [20-22], industrial [21], aircraft installations [23], stationary [18]).

Another aspect to mention is that batteries are typically tested when they are fresh/new, i.e. ageing effects are not accounted for. The ageing influence on the safety characteristics is not yet well understood [24].

Few TR tests try to simulate internally driven failures (Internal short circuit, ISC), such as the nickel particle method [15] or the wax material method [25]. Worryingly, the suitability of these tests to represent field failures remains disputed [19, 26]. Also other safety tests carried out in a controlled environment (e.g. heat, overcharge) do not

necessarily replicate the conditions under which safety incidents have been reported to occur in the field [7] and can with difficulty satisfy the needs for all types of batteries (e.g. cell geometries, cell assemblies) and designs. The development of innovative tests to adequately simulate field failures is extremely challenging; the potential trigger methods should not, in principle, introduce extra energy apart from that inherent in the tested cell and should ideally only involve few electrode layers. Additionally, the manipulation of the device to be tested should be minimised.

Furthermore the selection of the cell to be initiated is not straightforward: while a cell in the centre of the battery could in certain cases represent the worst case with respect to heat removal, it may not be easily accessible e.g. by nail-penetration. Finally, there are issues with repeatability and reproducibility, as thermal propagation depends on a delicate balance between heat generation and heat removal. A slight change in the test conditions might lead to cell to cell propagation in some circumstances, but not in others.

Full module or even pack level testing contributes to improve understanding of propagation useful to battery developers, product designers and OEMs. However, up to now, no scientifically sound testing method has been developed for regulatory purposes (e.g. vehicle certification). Upcoming developments worth mentioning include the introduction of a thermal propagation requirement into the Global Technical Regulation on Electric Vehicle Safety (GTR-EVS) [27], and into a SAE standard for lithium metal and lithium ion batteries (LIBs) as cargo on aircraft [28].

Session 1. Thermal runaway: mechanisms and influencing factors

Thermal runaway (TR), which is the most safety-critical failure mode of battery cells, can be defined as an uncontrolled increase in the temperature of a rechargeable energy storage system (RESS) driven by internal exothermic processes. However, there is no agreed definition and various options appear in different standards and regulations (UL 2580 [29], UNECE GTR-EVS Phase I [27]). As discussed by the participants to the workshop there was a **general agreement that there is a need for a harmonised TR definition.**

A TR event is potentially of a hazardous nature (with associated fire, explosion, gas evolution); the earlier it is detected, the earlier safety measures can be taken. Overall there is a **need for developing accurate and fast early detection tools.**

Figure 1 shows an indicative typical evolution of a TR reaction and associated physicochemical processes over time. The processes start when the limit of thermal stability of the chemistry within a battery is exceeded. Then, a chain of chemical reactions start, involving electrolyte evaporation and gas evolution which eventually lead to melting of shutdown separator (e.g. PE ~ 130 °C), triggering of the cell burst disk, and subsequent reactions: electrolyte/binder decomposition, cathode active material degradation, amongst other reactions.

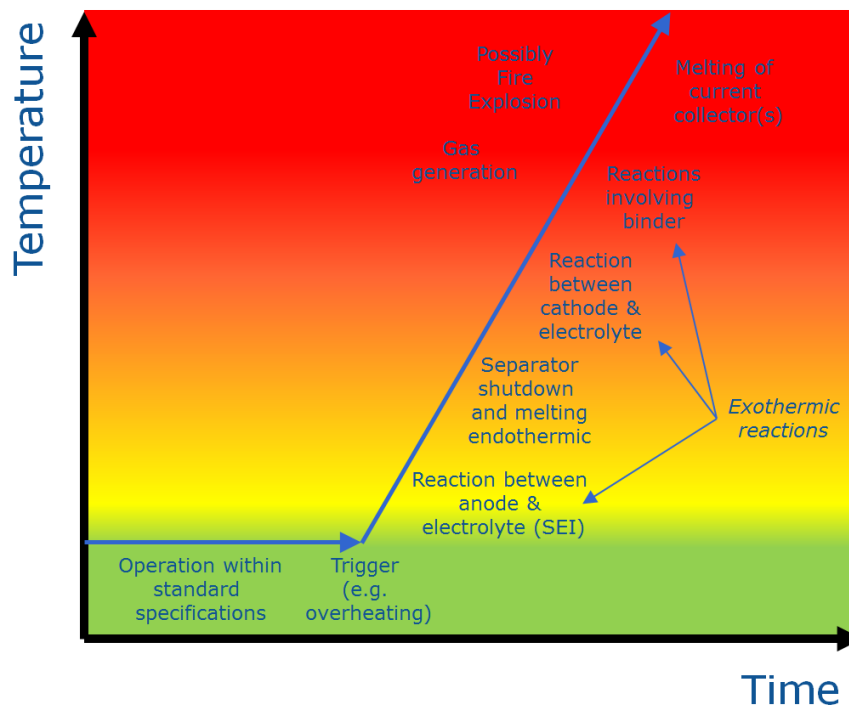

Figure 1. Typical evolution of thermal runaway in a Li-ion cell. The scales are given in arbitrary units and the reactions shown separately may occur simultaneously. Reprint from [30]

As a consequence of TR, cell voltage drops and overall cell temperature increases. Heat is generated by several sources: intrinsic electrical power, decomposition of solid electrolyte interphase (SEI) (~ 150 J/g), decomposition of electrolyte (~ 250 J/g), decomposition of anode (~ 350 J/g), reaction of oxygen (from cathode) with the electrolyte solvents (~ 450-600 J/g). Many factors affect the amount of heat released: cell type, initiation method, air/oxygen availability, heating rate, ignition/no-ignition, cell status (ageing/SOH), SOC, battery design (plastics, cables, electronics, etc.). Also the method used to analyse the event can have an influence (e.g. DSC and ARC can only assess a part of the heat released upon TR).

The extent (e.g. maximum temperature, rate of heat generation vs. rate of heat dissipation) of the thermal event is also dependent on several factors: short circuit

resistance, internal cell resistance, and cell thermal environment amongst others. Also, in typical Li-ion cells, reaching the stage of anode decomposition can be determinant for the severity of the event.

The "triangle of fire" components are present in the battery constituents itself: oxygen (present in the cathode materials), combustible substances (electrolyte, separator, anode material) and heat (external or internal to the battery). Therefore fire events are likely to occur upon TR. A controversial aspect of TR testing relates to the fact that some standards require the presence of a spark source during the experiment (e.g. UL 2580 and SAND 2005-3123 [29, 31]), and others not (e.g. ISO 12405-3 [32]). Therefore, the "no fire" pass/fail condition is tested in a completely different environment. On the one hand, spark sources are additional risk scenarios and impose additional technical hurdles, and on the other hand, in case of an abusive condition it is likely that spark sources are present in the vicinity of the event.

There are a variety of causes that can trigger battery thermal runaway: overcharge, overheat, short circuit, etc. Failures that can lead to thermal runaway can be classified into external to the cell (e.g. external short circuit, external fire, overcharge, crush) or internal to the cell (e.g. Li dendrites, Cu dendrites, manufacturing defects). From the possible scenarios, the presence of manufacturing defects is by far the most worrying. In fact, these cannot be predicted, nor intercepted by current battery management systems (BMS).

The European Council for Automotive (EUCAR) sets hazard levels for battery failure [31] which are widely used in automotive industry during the battery design phase. In this context a test is considered failed at hazard levels ≥ 5 (fire or flame, rupture or explosion). Such cells are not used in automotive applications, but rather sold by cell manufacturers for small scale applications.

Several participants raised the concern around the use of EUCAR hazard levels as descriptions of levels need improvement and updating. A more elaborate description of each level is advisable in order to avoid misinterpretations.

Some other issues raised in the session in relation to the EUCAR hazard levels:

- Qualitative evaluation, open to interpretation in some cases
- Boundary conditions are not defined
- Acceptance criteria are not clearly defined
- Definition of fire is unclear
- Not relevant to stationary storage applications

As an alternative, a proposed approach for quantitative analysis of cell safety behaviour was presented² based on: total heat released, the amount and nature of the gases released, precise temperature vs. time profiles, and reaction times.

Based on experimental evidences of measurements carried out for a 53 Ah graphite/nickel manganese cobalt oxide (NMC) cell in an autoclave chamber², a close to linear correlation between the weight loss of the Li-ion cell after the thermal event and the heat transfer to the metal block surrounding the cell was found. In general it was observed that the weight loss increases with the energy density of the cell under investigation, although there can be variations due to for example the cell format, design of the rupture disk and the amount of electrolyte. This approach allows calculating the total amount of chemical energy contained in a cell (abuse condition). With the assumption that at zero weight loss there is no heat released (ideal case where the heat is quantitatively transferred to the metal block), a total heat of 21 kJ/Ah is calculated for the case investigated². Electric energy (normal condition) for a 3.65 V cell having a capacity of 1 Ah results in 13 kJ. This results in an energy-ratio between $E_{\text{chemical}}/E_{\text{electric}}$ of ~ 1.6 . The energy-ratio could be useful in assessing the severity of a potential safety

² S. Scharner (BMW) presentation: "Quantitative safety characterization of Li-ion cells". Online access: <https://ec.europa.eu/jrc/sites/jrcsh/files/quantitative-safety-characterization-of-li-ion-cells.pdf>

event. As a drawback of this method, it can be mentioned that the ejected material transports heat into the autoclave chamber which is not measured and it is not accounted for in the total amount of heat production.

The heat released upon TR can also be obtained by using a Heat Distribution Calorimeter³ designed for single cylindrical cells. This device allows decoupling the heat generated within the cell casing and the heat generated by the ejected material (e.g. jellyroll). The device is X-ray transparent which allows for in-situ high X-ray speed imaging. In general, it was found that higher energy cells released more heat and that over 60 % of that heat generated during TR originates from ejected material³.

Another parameter of great importance when studying a thermal runaway is the reaction time. From the gas pressure curve inside the autoclave chamber (see **Figure 2**), such reaction time can be calculated taking into account the starting time of the reaction (voltage drop accompanied by sharp increase in the cell pressure), the maximum gas pressure reached and the following equation: $(p_{\max} - p_{\text{EQL}})/2$, where p_{EQL} is the gas pressure at equilibrium and p_{\max} is the maximum gas pressure².

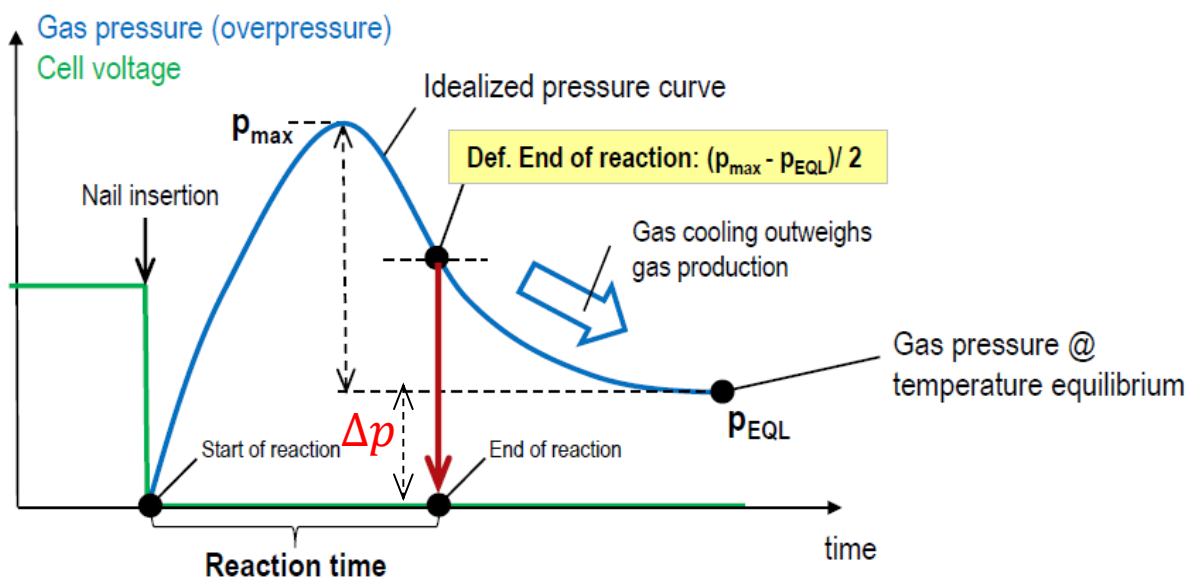

Figure 2. Schematic representation of a pressure curve inside the autoclave chamber during a thermal runaway event as presented by ²

The total amount of gas released can be calculated from the equation of ideal gases taking into account the gas pressure at temperature equilibrium Δp (**Figure 2**)². The amount of gas under standard conditions of pressure and temperature (1013 hPa; 25 °C) is around 1-2 l/Ah (which correlates to around 14 % cell weight loss). In general, the maximum gas volume emitted (without combustion) during TR of various types of Li-ion chemistries and various types of abuse is roughly linearly proportional to the cell size⁴.

Additionally, based on experimental evidences², it was found a close to linear relationship between the energy density of the cell (Wh/kg) and the maximum cell surface temperature upon TR, whereas the heat flux (W/cm^2) averaged over the reaction time

³ E. Darcy (NASA-Johnson Space Center Houston) presentation: "Lessons learned for achieving passive thermal runaway propagation resistant (PPR) designs for spacecraft batteries". Online access: <https://ec.europa.eu/jrc/sites/jrcsh/files/eric-darcy-nasa-lessons-learned-passive-thermal-runaway-propagation-resistant-designs-spacecraft-batteries.pdf>

⁴ C. Chanson (RECHARGE) presentation: "Characterize the lithium batteries thermal run-away reaction". Online access: https://ec.europa.eu/jrc/sites/jrcsh/files/claude-chanson_characterize-lithium-batteries-thermal-run-away-reaction.pdf

shows an exponential relation with both the energy density and the cell surface temperature.

The extrapolated total reaction enthalpy from the measurement of the 53 Ah cell subjected to TR runaway can also be calculated (according to Hess's law) assuming: isobaric conditions, conservation of mass for each element and maximisation of released heat of reaction. First, calculating the energy required to decompose the cell contents into its elements (3.145 kJ/g), then calculating the energy required to synthesise the reaction products (-4.212 kJ/g). This gives a calculated reaction enthalpy of -1.067 kJ/g, in agreement with the experimentally measured value (-1.071 kJ/g)².

Another technique typically applied for understanding the thermal behaviour of a battery system, typical temperatures, generated heat and heat flows is Accelerated Rate Calorimetry (ARC) as presented in the workshop⁵. The heat flow \dot{Q}_g can be expressed as the sum of irreversible and reversible heat flows:

$$\dot{Q}_g = \dot{Q}_{irrev} + \dot{Q}_{rev} = -I(E_0 - E) - IT \frac{dE_0}{dT} \quad (1)$$

where I is the current, T temperature, E_0 open circuit voltage, E voltage under load.

ARC testing allows the determination of generated heat using different operating modes:

- Adiabatic mode: defined by no heat exchange between sample and surroundings; the environmental temperature of the chamber, T_c , follows the sample temperature, T_s , (ideally $T_c = T_s$ to ensure adiabatic conditions).
- Iso-peribolic mode: defined by constant environmental temperature.

In both modes, upon determination of the cell's effective specific heat capacity, it is possible to determine separately heat generated reversibly and irreversibly.

It should be noted that ARC testing does not only allow the determination of heat flows during normal operating, but also under abusive conditions (where chemical reactions will contribute significantly or even dominate the heat generation), typically via the Heat-Wait-Seek method.

ARC testing allows the identification of different reactions taking place at different temperatures (e.g. decomposition of SEI, anode and cathode reactions with electrolyte, combustion of the electrolyte). Further information can be acquired by combining ARC testing with gas analysis or by measuring pressure changes inside a cell. Related to this, methods for the measurement of both external and internal pressure, where also temperature could be monitored in parallel, were presented at the workshop⁵.

The possibility of using nail penetration testing within an ARC can provide additional useful information⁵.

Finally, post-mortem analysis can be considered as a very useful approach to gain further understanding of the processes during a TR event. Techniques such as inductively coupled plasma (ICP) and X-ray diffraction on harvested materials from a battery cell can provide valuable information. The analysis of the reaction product inside a NMC/graphite cell being subjected to a TR reaction (steel nail penetration with nail speed: 8 cm/s) shows strongly reducing conditions experienced by the cell during TR as the reaction product contains Li_2CO_3 , LiAlO_2 , MnO , Ni, Co species being identified in the X-ray diffractograms. Additionally, analysis of ejected materials during TR (e.g. by gas chromatography) can also provide additional input.

⁵ M. Rohde (KIT) presentation: "Safety studies on Li-ion cells using combined calorimetric and electrochemical methods". Online access: https://ec.europa.eu/jrc/sites/jrcsh/files/magnus-rohde_safety-studies-li-ion-cells-calorimetric-electrochemical-methods_.pdf

1.1. Factors influencing occurrence and extent of thermal runaway

There are a multitude of factors that influence the thermal runaway reaction process and its consequences. Based on the assessment of the workshop presenters the following were identified as major contributors.

1.1.1. State of charge (SOC)

Based on experimental evidences shown by some of the presenters the thermal runaway onset temperature (T_{onset}) depends on the SOC level of the cell⁶. Experiments on fresh 2.2 Ah NMC ($\text{LiNi}_{0.5}\text{Co}_{0.2}\text{Mn}_{0.3}\text{O}_2$)/graphite 18650 cells, revealed that T_{onset} decreases when increasing the SOC (0, 50, 100 %) from ~140 °C to ~90 °C. Additionally SOC also impacts heat release upon thermal runaway⁷.

1.1.2. State of health (SOH)

Experiments performed on commercial 2.2 Ah NMC/graphite 18650 cells at 20 °C and 45 °C lead to a degradation of the cells (SOH at 70 % of the initial capacity), reaching < 400 cycles and > 1100 cycles, respectively⁶. The conditions for the ageing cycling were: constant current-constant voltage (CC-CV) charge at 1C (CV phase < C/20) up to 4.2 V and CC discharge at 1C down to 2.5 V. To have a deeper knowledge of the degradation mechanisms taking place under these conditions, several complementary techniques were explored. Focussed Ion Beam Scanning Electron Microscopy (SEM-FIB) analysis of harvested samples at 80 % SOH showed insufficient SEI formation, with signs of co-intercalation, followed by exfoliation, decomposition layer and potential lithium plating, all signs of significant cell degradation. Magic angle spinning (MAS) nuclear magnetic resonance (NMR) of ⁷Li (at 80 % SOH) showed the presence of deposition of "mossy" metallic lithium for the sample cycled at 20 °C, not visible in the sample cycled at 45 °C, confirming a more effective SEI layer at higher temperatures.

Heat-wait-search experiments in an ARC⁶ were also performed with heating steps of 5 K, followed by 30 min waiting steps and an identification of T_{onset} through self-sustained exothermic reactions when ≥ 0.02 K/min. This technique allows identifying the self-heating rate of the cell owing to the quasi-adiabatic conditions imposed to the system. When the heating rate is > 10 K/min, the temperature of TR is defined (T_{TR}).

Although in general T_{onset} decreases when increasing the SOC, as previously mentioned in section **1.1.1 State of charge**, significant differences could be analysed for the two ageing protocols compared by the presenter⁶. The cell cycled at 20 °C presents less dependency of the two parameters, attributed to the presence of metallic lithium, and the T_{onset} values are systematically lower. On the other hand, the cell cycled at 45 °C presents higher T_{onset} values than a non-aged cell (assigned to its thermally stable SEI). Therefore, the T_{onset} depends on the ageing experienced by the cell. Regarding the TR temperature experiments showed little to no dependency on the SOH, with values around 210-220 °C⁶.

In a separate experiment⁵ it was shown that aged cells present a lower T_{onset} compared to a fresh cell and also produce a higher temperature rate, whereas the maximum TR temperature reached was fairly similar (~230-250 °C).

Some discrepancy on this topic was shown by other participants to the workshop, as some participants considered that cycled/aged cells would be "safer" than fresh ones in terms of the amount of heat/energy which potentially can be released by a TR and

⁶ M. Börner (University of Münster) presentation: "Factors influencing the thermal stability of lithium ion batteries – from active materials to state-of-charge and degradation". Online access:

<https://ec.europa.eu/jrc/sites/jrcsh/files/factors-thermal-stability-of-li-ion-batteries.pdf>

⁷ F. Larsson (RISE) presentation: "Thermal propagation in lithium-ion batteries". Online access:

<https://ec.europa.eu/jrc/sites/jrcsh/files/thermal-propagation-in-lithium-ion-batteries.pdf>

reaction temperature limit for thermal stability. In principle, cells that have been aged by mostly calendar ageing, where degradation is driven by spontaneous side reactions which produce heat/entropy, can be considered "safer" than fresh cells. However, cells that have been aged by electrochemical cycling are less predictable (e.g. presence of dendrites produced by high charging rates). Other important parameters are for example the TR onset temperature, released chemical composition and fire characteristic profile. In order to determine "battery safety" a holistic perspective is needed.

In any case, and as suggested by some participants, **TP testing would be advisable on aged systems, as it seems that the safety of these systems is yet a complex and unknown matter.**

1.1.3. C-rate

Thermogravimetric analysis (TGA)⁶ on commercial 2.2 Ah NMC/graphite fresh and cycled cells at different C-rates (C/5, 1C and 2C) charged up to 4.7 V displayed a profile with 4 different features: *i)* <150 °C, the residual electrolyte components and their decomposition products are evaporated, *ii)* between 275 °C and 375 °C there is a phase change accompanied by oxygen release from the cathode active material, *iii)* between 350 °C and 450 °C the PVdF binder decomposes and, lastly, *iv)* at temperatures higher than 450 °C there is another phase change with oxygen release.

Increasing C-rate results in a higher derivative weight vs. temperature, which implies a larger mass loss per temperature step and a faster oxygen release. Additionally, increasing C-rate results in a larger surface area consisting of a highly unstable delithiated structure which can cause degradation effects that clearly influence the thermal stability and the safety properties of the cell. Overall, the results obtained indicate a reduced thermal stability after cycling at higher C-rates compared to the fresh material.

1.1.4. End of charge voltage limit

Thermogravimetric investigations on commercial 2.2 Ah NMC/graphite fresh and cycled cells at different end of charge voltage limits (4.20 V, 4.45 V, and 4.7 V) and same C-rate (2C) showed a minor influence on the thermal stability corresponding to the process between 275 °C and 375 °C (phase change accompanied by oxygen release from the cathode active material) and around 450 °C (PVdF binder decomposition) as compared to the effect of C-rate⁶. However, the rest of processes are affected, thus the higher the cut-off voltage, the higher the derivative weight, which is also higher compared to the fresh material.

1.1.5. Active cathode material

TGA experiments⁶ showed high thermal stability of Lithium iron phosphate (LFP) in both the charged and the discharged states. In the case of Lithium nickel manganese oxide (LNMO) there is a reduced thermal stability in the charged state (4.9 V) due to the presence of Ni⁴⁺ (phase change accompanied by oxygen release), also the binder decomposition shows a higher derivative weight compared to the discharge state (3.0 V). Similarly, both NMC111 and NMC622 showed decreased thermal stability in the charged-delithiated state (4.2 V).

In a separate experiment carried out by another presenter⁵, three different cathode materials were assessed (NMC, LMO, LFP). In the region between 80-130 °C (region attributed to the exothermic SEI decomposition) a similar behaviour was demonstrated by the three materials. Next, between 130 and 200 °C (region assigned to the solvent reaction, exothermic reaction between intercalated Li and the electrolyte and the reduction of electrolyte at negative electrode), LMO showed the most rapid increase in temperature (up to ~ 600 °C), followed by LFP (~ 250 °C) and finally NMC (~ 700 °C). At temperatures > 200 °C, the exothermic reactions between active positive material and electrolyte leading to a rapid generation of oxygen occur. In regard to the overall

temperature rate (in °C/min) upon TR vs. temperature, NMC reached a higher rate, followed by LMO and a much lower rate for LFP.

1.2. Chemical hazards and related considerations

A complex mixture of flammable/toxic gases is expected to be emitted during a thermal event in a Li-ion cell even at relatively low temperatures (< 100 °C). However, this is covered by a relatively limited number of publications [5, 6, 24]. Confined spaces add an extra dimension to the problem (e.g. tunnels, underground car parks). Moreover, there can be gas release before and without thermal runaway, involving multiple vents, which might not be visible to the naked eye [24].

Below we present an overview of the points discussed during the workshop considering chemical hazards.

1.2.1. Hydrofluoric acid (HF) and other fluorides

Hydrogen fluoride has been the focus of toxicity research in LIBs due to its hazardous nature [5]. Other fluoride gases (e.g. POF_3 emissions at ~200 °C [24]) are also present in the emissions stream, but have not received much attention in the literature [5, 24] and little or no toxicity data is available.

The sources of HF are basically:

- PVdF: polymeric binder is typically used in batteries, which upon decomposition leads to the formation of HF at elevated temperatures (> 400 °C).
- LiPF_6 salt: used in most battery electrolytes. It decomposes at high temperatures into LiF and PF_5 ; PF_5 forms HF with the organic solvents of the electrolyte.
- Fluorine based additives which can be present in the battery electrolytes.

The amount of HF that can be released in a thermal event involving LIBs, depending on the type of cell and SOC, ranges between 20-200 $\text{mg}_{\text{HF}}/\text{Wh}$ as measured during fire tests of 7 commercial 6.8 Ah LIBs⁷. Extrapolation to a 100 kWh battery pack fire would result in 2-20 kg_{HF} . This translates to an Immediately Dangerous to Life of Health (IDL-2= 25 mg/m^3 ; immediately dangerous to life or health within 30 min) in a volume range 80,000-800,000 m^3 . A volume reduction by a factor 5.6 would translate to a lethal 10-minute value (acute exposure guideline level (AEL) 3= 139 mg/m^3). The scenario of a confined space leads to an even more worrying situation. The total amount of fluoride compounds can be measured during TR using gas-washing bottles⁷.

Values ranging 4-5 g of fluoride were measured in the range of SOC from 0 to 100 % for the commercial 6.8 Ah LIBs studied by the presenter⁷ [5].

HF can also be emitted during internal combustion engine vehicle fires [33] (from fluorinated materials contained in the vehicle such as refrigerant in the air conditioning, plastics), but in lower quantities compared to the amount of HF emitted in EV fires.

Research towards toxic gas dispersion in confined spaces, such as tunnels or underground parking is needed.

A discrepancy of opinions around this topic became obvious. Some participants to the workshop claimed that only traces amounts of HF would actually be released as a significant part of it would rapidly react with for example LiCoO_3 , Al_2O_3 and the aluminum (current collector).

1.2.2. Cathode active material

There is a general belief that some cathode materials are "safer" than others, however an overall safety assessment is required. A prototypical example of a "safer" cathode material is LFP. Typically upon TR it generates less heat and seldom ignites, but without fire/combustion of the emitted gases, there is an increased risk for

gas explosion due to for example delayed ignition⁷. This highlights the need to carry out an overall safety assessment, which not only includes the battery size and design, but e.g. also the environment where the battery is used.

1.2.3. Flammability and oxygen availability

Combustion of combustible substances emitted by the cell upon thermal runaway will increase the amount of total heat generated. This increase can be estimated to be a factor of 3-4 higher compared to the situation without combustion. Based on some experiments performed on commercial cells upon full combustion of all components (100% efficiency), the combustion energy can reach ~5-20 times the electrical energy⁷ [5].

Based on the literature and the non-published data presented in the workshop⁴, it has been reported that the total heat released (obtained by integration of the Heat Release Rate (HRR) curve) measured with complete combustion is proportional to the cell size with absolute values ranging 4 to 10 MJ/kg maximum (compared to the combustion of paper and plastic in the range of 10-40 MJ/kg), whereas the heat released in the TR reaction only (calculations based on the maximum temperature of cells/batteries and specific heat) falls < 1 MJ/kg for various types of Li-ion chemistries and various types of abuse.

HRR per kg of batteries may decrease with heavier batteries because not all the cells within the battery assembly are reacting simultaneously. Therefore maximum HRR does not scale with the weight of the battery. However, the total energy release, which is the accumulated HRR over the complete burning time, given that the battery pack is fully combusted, will scale with weight.

The degree of combustion influences smoke/gas composition⁷. Moreover, if there is no fire, toxic and flammable gases can accumulate and cause a delayed ignition (via auto ignition due to hot parts/electrical connections, sparks, external sources, etc.) or even a gas explosion, which can be more severe. Battery size, exposure and its environment are important for safety considerations. Generally speaking, gas release without flame/ignition typically renders more toxic gas compositions.

A factor, which is often not considered, is that typically only limited amount of air (and oxygen) is present inside battery enclosures and that can have a significant impact on reactions and severity of the thermal event.

Another point to consider is that the use of some additives or flame retardants may be contra-productive, enabling the buildup of more toxic/flammable gases, with higher risks for gas explosions, which may be the worst case situation.

1.2.4. Firefighting considerations

Firefighting of Li-ion batteries is typically not well studied⁷. The usual recommendation is to use large amounts of water (cool down effect). As pointed out by the presenter, this could raise several issues: non-availability of large amounts of water, design of the battery packs might make difficult accessing the inside cells (e.g. IP67 protection), likelihood of fire re-ignition and finally, the disposable water used in the exhaustion has a rather toxic nature (capture and transform the toxic gas problem to a toxic liquid problem).

Additionally firefighters would potentially encounter the situation that HF gas may penetrate their ordinary suits, thus the use of a HF detector sensor could be advisable. The use of breathing filters and chemical protection suits by the firefighter brigade was discussed; the use of environment independent breath units or at least filter mask is absolutely necessary extinguishing Li-battery fires. However, cost is the major drawback as pointed out by some participants.

On the contrary, other workshop participants were less concerned in regards to the toxicity of emitted HF, as HF reacts readily with many materials to form fluorides (SiO_2 , Al_2O_3 , etc.) with limited water solubility, therefore reducing the toxicity hazard towards safety personnel. Future research on this respect would be highly desirable.

Session 2. Thermal Propagation

The objective of thermal propagation testing is to verify that a lithium ion battery module or pack can withstand a single cell TR failure. In principle, failure of one cell should be contained within the battery pack and not cause its entire destruction ('benign failure'). This is more relevant for large format applications such as automotive or stationary grid power applications and applications where egress of people is a concern⁸.

Correlation of thermal runaway energetics to the observation of failure propagation can inform and guide battery pack design. Other contributing factors that need consideration are the presence of heating (adjacent fire heating, ejecta of cell parts, short circuit heating, heat sink packaging, etc.) and cooling strategies. A cell may exhibit dramatically different failure response when in a string, a module or a pack than during single cell abuse testing⁹.

Comparative results on single cells (LFP, 26650 type) and a 10 cell arrangement (1s10p) demonstrate this statement⁹. Whereas in the first case, cell temperatures rise quite moderately to a maximum value of around 100 °C within the first minute after initiation followed by cooling off, in the second case, temperatures approach 370 °C for the initiated cell, and around 250 °C for the neighbouring cells in a two-step profile (first temperature rise ~2 min and a second temperature rise ~12 min). Therefore thermal propagation testing at higher levels of assembly (e.g. module or pack) is of great importance, as the behaviour of a single cell (despite being relevant) is not necessarily indicative of battery module or pack performance.

In general it can be assumed that cell level failure is determined by intrinsic cell properties, whereas module or pack level failure is predominantly affected by engineering/design⁸.

2.1. Factors influencing thermal propagation

Cell to cell propagation is influenced by the TR characteristics of the cell and it is determined by the balance between heat generation and heat removal. Also the short circuit current is a fundamental parameter in the process (which ultimately contributes to heat transfer). TP propagation is influenced by many other parameters: the starting temperature of the system, the heat conduction between adjacent cells, the mechanical structure of the module or pack, the cooling strategy and cooling power, etc.

Total heat released is important as well as the heat release rate. This can be influenced by multiple factors: cell type, SOC, cell status (ageing/SOH), availability of oxygen, type of abuse (e.g. external heating, fire, overcharge, and mechanical crush), presence of an ignition source, etc.

The ideal operation temperature of Li-ion batteries is in the range 20 – 40 °C. It is important to assess the homogeneity of the temperature distribution within a battery pack: depending on the application and requirements, the temperature spread between different cells should be as low as possible (typically a few degrees) and the temperature difference within one cell should also be minimised (~10 °C might still be acceptable). Higher temperature spreads might lead to rapid ageing or imbalance between different cells⁵.

⁸ D. Doughty (Battery Safety Consulting) presentation: "The landscape of thermal runaway propagation testing". Online Access:

https://ec.europa.eu/jrc/sites/jrcsh/files/daniel_doughty_battery_safety_consulting_the_landscape_of_thermal_runaway_propagation_testing.pdf

⁹ C. Orendorff (Sandia National Laboratories) presentation: "Fundamentals of failure propagation in lithium-ion batteries". Online access:

https://ec.europa.eu/jrc/sites/jrcsh/files/christopher_j_orendorff_sandia_national_laboratories_mechanisms_and_m.pdf

Several design strategies can be exploited in order to mitigate TP. Some of the most relevant ones are discussed in detail in **Session 4: Safety strategies**.

In the following several factors will be discussed supported by the results and investigations presented by the speakers to the workshop.

2.1.1. Cell type and cell to cell electrical connections

In the case of cylindrical cells, it has been reported that the thickness of the wall can have a significant impact on the propensity towards side wall breaching/ruptures³. For cells having > 660 Wh/L, the propensity is rather high. Also the crimp burst pressure of the safety vent can impact the occurrence of ruptures. The ejection of cell components, hot gases and electrolyte towards adjacent cells (which can cause circulating electrical paths, on top of creating an additional heat source) likely influences the cell to cell propagation.

The effect of the cell to cell electrical connection was presented⁹. For this, the propagation behaviour of 1s10p and 10s1p arrangements was compared. Initiation of one cell was carried out by nail penetration along the longitudinal axis, both on the edge of the assembly or the centre of the assembly. Three types of cells were investigated: LCO 18650, LFP 18650 and 26650 cells. Results for LCO cells showed complete propagation for the 1s10p arrangement (regardless of the initiating cell location) and a range of responses for 10s1p arrangement, from limited to complete propagation. As a contrast, LFP 26650 cells in 1s10p arrangements showed no propagation, however after installation of a copper bus cell to cell propagation was observed demonstrating how the pack design impacts the ability for failures to propagate.

Mechanical abuse via nail penetration of NMC cells (18650 type) in a 1s2p configuration was also presented⁹. The cells were connected through a bridge wire and the effect of this connection in the TP process was evaluated. For this, efforts were made to maintain the electrical connection between the two cells after TR (using a spring on the nail that applies an opposing force, keeping the cell from ejecting out of the enclosure upon TR). In both setups, the peak currents measured across the bridge during failure propagation were consistent (~ 50 A), however the total energy discharged into the initiation cell varies depending on the robustness of the electrical connection: 0.027 kJ and 5.3 kJ for the cells without and with spring, respectively. In the first case there was a loss of electrical connection, which stops the discharge of the neighbouring cell into failure point avoiding TR.

2.1.2. Active cathode material

The short circuit current measured during failure propagation for different chemistries shows that LFP is, in principle, a more benign cathode material as it is able to sustain high discharge currents during a longer period of time releasing a higher total energy during discharge compared to LCO, NMC and NCA based batteries⁹.

Comparing a same type of configuration, 1s10p arrangement of cylindrical cells, it was demonstrated in **2.1.1 Cell type and cell to cell electrical connections** that propagation occurred for LCO based cells but not for LFP based cells⁹.

2.1.3. State of charge

As previously mentioned, the state of charge of the battery cell has a great impact on its thermal runaway behaviour. Thus it is not surprising that the SOC influences the cell to cell propagation behaviour of a module or pack.

When evaluating a 5 cell string of pouch cells based on LCO chemistry (3 Ah), at two different SOCs (50 and 80 %) it was observed that there was no TP propagation in the case of the lower SOC, contrary to the situation with higher SOC (total pack propagation occurred in < 4 min). Also there was a significant difference in the maximum temperature reached. At 50 % SOC the initiated cell only reached < 100 °C (< 50 °C for

the neighbouring cells), whereas at 80 % SOC the maximum temperatures achieved ranged 400-550 °C⁹.

2.1.4. Thermal runaway initiation method

Several safety incidents that took place in the field were attributed to an internal short circuit that was not detectable or predictable at the time of manufacture. This can be attributed to either a latent defect which gradually moves into position to create an internal short while the battery is in use, to an inadequate design or to an operation (cycling) off-limits which can cause Li plating, eventually stressing the separator to the point where anode and cathode electrically connect. Current abuse test methods designed to mimic an internal short circuit event (e.g. crush, nail penetration, overcharge) may not be representative of field failures. Therefore there is still a great controversy around the selection of a TR initiation method¹⁰. In fact, to date, **no reliable and practical method exists to create on-demand internal shorts in Li-ion cells that create a TP and that produce a response that is relevant to the ones produced by field failures**. Thus, currently "traditional abuse testing" is the only alternative to evaluate TP in a testing environment.

Preliminary results were presented on a 5 cell string of pouch cells based on LCO chemistry (3 Ah), comparing nail penetration and overcharge (1C) initiation methods⁹. In general it can be stated that the initiation by overcharge is more energetic, with a faster heating rate compared to the initiation by nail penetration. However, the overall performance of the module was fairly similar for the two methods; similar maximum temperatures (ranging 500-700 °C), similar time to complete propagation (~1 min for overcharge and 1 min 20s for nail penetration). This experiment leads the presenter to conclude that the different amounts of energy introduced by different initiation methods may have little on the TP performance of the system.

2.2. Simulation and modelling of thermal propagation

TP testing of large, complex systems is fairly resource intensive. Modelling and simulation represent a potential remedy to this, allowing deducing a large amount of information from a relatively small number of tests.

An electro-thermal and abuse model using lumped cell materials properties was presented⁹. For this LCO pouch cells were arranged in a 1s5p configuration. TR was initiated via side nail penetration on the centre of the module. In general, there was a good agreement between the initial simulations and the experimental results with some deviations, particularly in the long lasting events likely due to electrical or connectivity changes within the battery during failure.

Another strategy presented by another workshop participant followed the next steps¹¹:

i) Development of an empirical method to investigate abusive behaviour to obtain input parameters and validation data. This step aims at identifying the triggering TR temperature (T_{onset}) and at measuring the heat released/generated. For this 2.5 Ah 18650 cells based on NCA chemistry using an ARC were abused by the steel nail penetration method. Based on the calorimetry data a release of 72 kJ was measured in the first 20 s into TR. The amount assigned to the gas was 30 kJ, although the test set-up employed allows for certain amount of the gas released to be excluded from the heat measurement. T_{onset} was obtained by the heat-wait-see method.

¹⁰ M. Keyser (National Renewable Energy Laboratories, NREL) presentation: "NREL/NASA internal short circuit instigator in lithium ion cells". Online access: https://ec.europa.eu/jrc/sites/jrcsh/files/matthew_keyser-nrel-nasa_internal_short_circuit_instigator_in_lithium_ion_cells.pdf

¹¹ E. Kolp (TUM) presentation: "Thermal modelling of thermal runaway propagation in lithium-ion battery systems". Online access: <https://ec.europa.eu/jrc/sites/jrcsh/files/thermal-modelling-of-thermal-runaway-propagation.pdf>

As mentioned in section **1.1.1 State of charge**, the T_{onset} decreases when increasing the SOC, however in these set of experiments the reduction was not very pronounced. Values range from ~ 150-160 °C at 0 % SOC, to ~ 135-145 °C at 100 % SOC. At higher SOC values (overcharged cells) the decrease in T_{onset} is significantly more severe, as values drop down to 80-60 °C in the SOC range from 110 to 145 %. The temperatures achieved have an implication towards the separator melting and the different mechanism upon TR.

ii) Simplified semi-empirical simulation model for thermal propagation

The model used by the presenter consisted of 12 fully charged lithium ion cells connected in series (including connectors and casing). A cell is triggered into TR (via nail penetration) and the simulated results are compared with the experimental ones.

Thermal conductivity (radial 0.01-3.4 W/m K and axial: 20.06-31.90 W/m K) and heat capacity (702-836 J/K kg) were determined by using a custom hot disk (transient plane source consisting of a heat source and a heat sensor).

The results of the simulation lead to a temperature increase from 20 °C to 470 °C in less than 2 s after cell initiation. After 10 s, neighbouring cells heat up to ~70 °C and after 110 s a cell to cell propagation occurs. Simulation shows that the design of the module itself affects the heat propagation.

Comparing simulation to the experimental results, significant divergences were found¹¹. Despite that significantly higher temperatures were measured in the experiment compared to those obtained by the simulation, there was no further thermal propagation. The presenter explained this discrepancy based on the design of the module enclosure; the set-up was designed to have an opening in a corner of the module enclosure; the gases released through that opening (heat release and direction of gas flow) were found to have a great impact.

In order to overcome the limitations explained above for the previous model, implementing the gas flow of the venting is necessary. A Computational Fluid Dynamics (CFD) model approach was explored as alternative. For this, the investigations of Colella [34] and Coman [35] who studied the hazard level of the environment to model ventilation and a lump model for venting, respectively, were taken as reference. Several assumptions were made for the 2D model: similar gas specifications to H₂, negligible heat transfer via the solid bodies (cell connectors) as well as of heat generated by the initiated cell. With the CFD model, contrary to the thermal model, the gas temperature inside the module can be taken into account. Contrary to the experimental observations, the simulation showed that the temperature of the side opening in the module and the neighbouring cells increases rapidly after the nail penetration due to the vented gas.

The presenter¹¹ identified the following issues and limitations of accurate modelling:

- 3D CFD modelling is time consuming.
- Uncertainty of input parameters (e.g. certain properties which are temperature dependent are not available, cell temperature measurements are typically done exterior to the cell, whereas the inside temperature would be more meaningful).
More information of temperature dependence of physical properties and behaviour of vented gas during TR are necessary.
- Accurate information of the venting is needed (e.g. vent size, vent position, heat release, mass rate, and velocity of gas).
- Nail penetration was found to be an unsuitable initiation method by the presenter (although considered to be useful by other participants to the workshop).
Standardised abuse testing regarding TP is required.

Final proposal by another presenter was based on LT-spice freeware computer software for thermal network simulation¹². Systems like Openmodelica or Dymola were also mentioned as suitable simulation tools. However, a library of thermal elements is needed (e.g. heat conductor, heat pipe, phase change material (PCM)). The use of cell internal thermocouples as demonstrated in **Section 3** is highly desirable. Finally it is suggested that the measurement of heat conductivity and heat capacity of failed cells would provide valuable input to the simulation. Ideally industry and battery manufacturers could use this tool in their designs to find joint solutions for preventing TP once TR has been initiated at cell level.

¹² A. Golubkov (Virtual Vehicle) presentation: "Initiation of thermal runaway with different heating devices".
Online access: <https://ec.europa.eu/jrc/sites/jrcsh/files/initiation-of-thermal-runaway.pdf>

Session 3. Thermal runaway initiation methods, fit-for-purpose testing related to external and internal abuse triggers

Thermal runaway initiation methods can be classified into two types: externally initiated triggering methods (e.g. of mechanical, electrical and thermal nature) and internally initiated triggering methods (e.g. electrode defect, incorporation of metals). They both aim at creating an artificial ISC that develops an initiating cell into TR. Then, the cell to cell propagation is investigated either at module or pack levels.

Below a small overview of the most common TR initiation methods is presented ^(13,14) summarising their pros and cons.

3.1. External triggering methods

3.1.1. Mechanical initiation methods

*Nail or
needle
penetration*



Nail penetration test is required in a number of standards (e.g. [20, 31, 36, 37]). The test simultaneously measures nail acceleration, cell temperature, cell terminal voltage, resistance and cell deformation.

This method results in a multi-layer damage and the outcome of the test is very dependent on several factors: position, nail characteristics, penetration depth, etc. Another negative aspect related to this method is that the selection of a cell within a module or pack can be restricted to those cells located externally as cells located in the interior of the casing can only be accessed with difficulties.

Occurrence of TR and its extent depends on nail and depth, tip shape, surface of the nail, alloy composition, etc.

Poor reproducibility.

Drilling of the pack casing is needed in order to access the initiating cell (special preparation of the module and special openings of the housing are essential for testing). Not feasible with most cell packs.

Similar tests: bullet firing, screw penetration, ceramic nail penetration.

Blunt rod





The blunt rod method [38], also known as the IIISC (Indentation Induced Internal Short Circuit), is not so widely used as the nail penetration method. It deforms the most outer electrode layers and eventually creates a short circuit.

Damage of separator followed by single or multilayer strike.

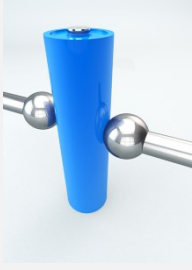

Results are more related to the mechanical properties of the separator, electrode structure, and influenced by the case design

Suitable for pouch cells, used for cylindrical cells, seldom applied for prismatic hard case.



¹³ Harry Döring (ZSW) presentation: "Initializing of thermal runaway for lithium-ion cells focusing on the effect of internal short circuit". Online access: <https://ec.europa.eu/jrc/sites/jrcsh/files/initializing-of-thermal-runaway-for-lithium-ion-cells.pdf>

<p><i>Crush</i></p>		<p>Similar difficulties as discussed above for the nail penetration method.</p> <p>Crush impact is a useful method to assess the robustness of a system (cell, module, pack, and vehicle (crash)).</p> <p>Multi-layer strike between electrodes, electrodes and construction elements.</p> <p>It might not be developing into TR necessarily.</p> <p>Initially not suitable as TP triggering method.</p>
<p><i>Pinch</i></p>		<p>Requires access to the cell from two opposite directions.</p> <p>Might be problematic to apply to a cell in a pack due to access limitation.</p> <p>Initially not suitable as TP triggering method.</p>
<p><i>Water immersion</i></p>		<p>Immersion in water does not only damage the battery itself, but also the electronics built into the battery.</p> <p>Presence of water also severely changes thermal properties of cells surrounding.</p> <p>Initially not suitable as TP triggering method.</p>

3.1.2. Electrical initiation methods

<p><i>Overcharge</i></p>		<p>The overcharge method is a possible initialisation method for TR, however one of its main drawbacks is that it adds additional electric energy to the system.</p> <p>Moreover manipulation of protection devices might be necessary; some cells are equipped with passive protection devices like a circuit interrupt device (CID), which might need to be disabled/manipulated prior to testing.</p> <p>Special preparation and wiring of the module to connect to a single cell is needed.</p> <p>High voltages might be needed when the cell contains stable separators.</p>
<p><i>External short-circuit</i></p>		<p>This method does not necessarily lead to TR in all types of cells (current might not be high enough to cause TR for a single cell).</p> <p>Additional uncontrolled heating of cell.</p> <p>Similar difficulties as discussed above for overcharge.</p>

3.1.3. Thermal initiation methods

<p>Heat</p>		<p>Heating methods add significant energy (thermal) to the system, add unwanted preheat to adjacent cells and manipulation for installation the heating device is necessary.</p> <p>Multi-layer strike via separator failing.</p> <p>Additional problems can be pointed out in the case of using a slow heating rate:</p> <ul style="list-style-type: none"> • slow thermal discharge of the cell, energy release of a longer time • neighboring cells get preheated for a longer time, promoting propagation effect
<p>Laser impact light beam</p>		<p>Single or multilayer strike.</p> <p>Can realise very small impact.</p> <p>Uneconomical, complex set – up.</p> <p>Special openings of the housing are essential.</p> <p>Impracticable in the normal everyday life of a testing facility.</p>

Heat exposure of a system may lead to a series of effects: SEI layer breakdown, electrolyte degradation, venting by evaporated electrolyte, reactions anode-electrolyte and cathode-electrolyte, gas formation, separator shut down, separator melting, internal short-circuit, massive energy release, fire...

Fast heating prevents excessive heating of neighbouring cells, however a good heat transfer to the triggering cell is required.

Heating of pouch cells can be realised by using a custom made sample holder with ceramic wool sheets in both sides of the cell¹² (see **Figure 3**). The holder is closed by screwing two stainless steel plates having four springs that simulate the mechanical forces inside a module. Four electric strip heaters are located in the external part of the holder, with two heaters on each side of it. Maximum expansion and gas pressure and gas composition (via GC/FTIR) can be measured with this set up.

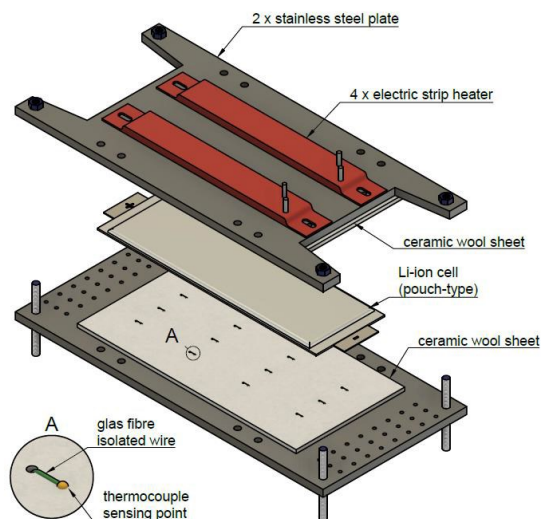





Figure 3. Example of pouch cell holder suitable for heating initiation method. Reprint from ¹²

By inserting thermocouples inside the pouch cell, most accurate measurements are ensured. Handling and manipulating the cell is obviously required, but the information obtained is more meaningful for creating a TR model. As an example in the results provided by the presenter¹², inside temperatures at the centre and outer parts of the electrode reached 1,000 °C whereas the temperature recorded by externally connected thermocouples varied between ~ 450-800 °C.

3.2. Internal triggering methods

Another strategy to initiate a single cell TR is to create an internally driven abuse to a cell. This can be achieved by several ways. A summary of those presented at the workshop is presented in the following. It should be mentioned that there is currently no simple way to transport modified cells, which means that cell preparation and test execution should be carried out at the same location.

<i>Nickel particle method</i>		Large manipulation (high effort; cells must be specially prepared by the cell manufacturer and have to be transported to the lab), not reliable.
<i>Metals with low melting point implantation</i>		Incorporation of particles followed by applied pressure.
<i>Wax based implantable device</i>		Single layer strike.
<i>Shape memory alloy (SMA) implantable device</i>		Large manipulation, not reliable. e.g. Wood’s metal, heat exposure for melting. Single layer strike.
<i>Internal heating device</i>		The method developed by NREL/NASA ¹⁰ [39] aims at simulating an ISC capable of triggering the four types of cell internal shorts: 1) anode to cathode, 2) anode to positive current collector, 3) positive current collector to negative current collector and 4) cathode to negative current collector.
<i>Shape memory alloy (SMA) implantable device</i>		Cumbersome manipulation.
<i>Internal heating device</i>		Single layer strike.
<i>Shape memory alloy (SMA) implantable device</i>		The SMA material is used to pierce the separator as it bends when heated [40].
<i>Internal heating device</i>		Cumbersome manipulation.
<i>Internal heating device</i>		Single layer strike.
<i>Internal heating device</i>		Heating device installed inside the cell. Heating occurs in a localised manner, but the insertion of the heating device requires significant manipulation of both at cell level and higher levels (module, pack).

The wax based initiating device, US Patent#: 9,142,189 [25], consists of a microcrystalline wax and an electrolyte-compatible PCM, which can be triggered by heating the cell above PCM melting temperature (presently 40 °C-60 °C). The device is rather small and implantable into Li-ion cells, preferably during assembly.

Some test examples obtained using the wax device are summarised in the following¹⁰. 8 Ah Dow Kokam cells at 10 % SOC were used in order to assess the different voltage profiles obtained for the four types of ISCs mentioned above. The combinations 1) and 4) resulted in a moderate voltage drop upon activating the ISC device, indicative of a less energetic SC. Then the combination 2) showed a more drastic voltage drop and a hard short circuit for the combination 3), with a SC duration of < 50 ms before cell OCV bounces back to nominal. Additionally, for the combination 3) melted Al was visible after test indicative of the high currents and high temperatures reached. The significant differences showed by the four combinations can explain the lack of reproducibility of certain ISC initiation methods. For example, testing of cells at 100 % SOC has shown TR when combination 2) is used but not in the case of combination 4).

Testing was also performed in fully charged cylindrical cells of 2.4 and 3.5 Ah¹⁰. Ejection of the jelly roll was observed upon TR, with the following features also visible: top edge of crimp shows reflow of steel, side wall breach in neck of crimp is clogged with ISC device and finally a smaller breach in can wall is slightly off the ISC device clogging and above it.

It is also worth mentioning that the position of the implantable device in the cell might impact the results³. Experiments were performed in cylindrical cells at various locations: 3 winds into the middle of the jellyroll, 6 winds into the middle of the jellyroll, 3 winds into the top of the jellyroll, 6 winds into the bottom of the jellyroll.

As demonstrated by the inventors of the method, overall the wax method is a reproducible and consistent method, which allows clear differentiation of the impact of the starting test conditions (*e.g.* SOC, age) which can provide relevant data for ISC models.

An example of internal heating device approach was also presented¹². A heater wire was inserted into a jelly roll. First attempts to generate a TR were unsuccessful as the wire failed before TR started. The internal short circuits induced damaged the cell significantly, making it more vulnerable to an external heating method. In a manipulated cell with inserted wires the TR started at 100 °C, whereas the same-not manipulated – cell would normally enter TR at around 200 °C. Whereas this experiment could not be considered fully successful, investigations on improved heating devices (SiN ceramic heater) are underway. Their small dimensions (*e.g.* down to 3 x 7 mm) makes them, in principle, a suitable candidate for part of type approval testing of battery packs and modules.

As conclusions related to this section, it can be mentioned that all initiation methods present serious disadvantages and may end in a different behavior of the module or system. Battery pack manipulation is unavoidable in most cases. Additionally, there is no method that is applicable for all type of cells¹⁴. Some methods might be able to drive a battery system into TR (*e.g.* by nail penetration) whereas other methods (*e.g.* overcharge, short circuit) might be unable to do so. Therefore in order to demonstrate that a battery system is robust towards TP, it is recommended to perform an initial assessment aimed at defining a triggering method at cell level, followed by the actual propagation testing triggered by the method adapted from that initial assessment. This approach can be summarised by the schematic depicted in **Figure 4**.

¹⁴ R. Hettrich (CTCadvanced GmbH) presentation: "Propagation tests on lithium ion batteries from the perspective of an accredited test lab"

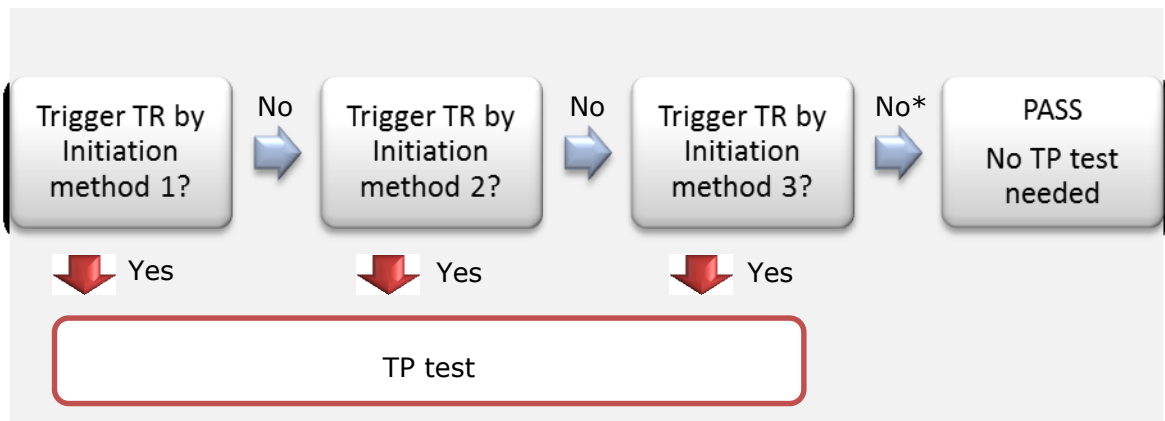

* number of iterations need to be decided

Figure 4. Possible TR and TP testing sequence

A practical aspect that deserves consideration relates to the testing set-up when performing ISC testing on single pouch-type cells. In this case there is a need to apply certain pressure to the cell in order to hold the pouch cell layers together¹⁰. Once the ISC is initiated gases evolve, and due to the flexibility of the packaging, cells tend to balloon. Therefore, in order to sustain the ISC, certain pressure perpendicular to the pouch cell needs to be applied.

Another aspect raised during the workshop, relates to the fact that fresh batteries (batteries at BOL) are likely to behave differently than batteries at end of life (EOL). In fact, some experiments were presented where a battery at EOL developed into TR upon nail penetration testing, whereas the same type of battery at BOL showed no visible reaction¹⁴.

Overall, safety tests have to be comparable between different test labs and should be reproducible, but in reality the test set-up has a big influence on the test result. Several examples that illustrate this situation are: *i*) the wiring to connect a single cell with the test unit may result in a short circuit of other cells due to overheat of the wire, resulting from the overcharge current¹⁴, *ii*) exhaust gases ignited by an external spark generated by a damaged test cabling, *iii*) fire leaves the housing (which would qualify as a fail for many standards) through special openings created for test wiring or for nail penetration.

Many parameters are not fully defined or can be misinterpreted in the existing testing standards, which obviously has a great impact on the test outcome and test to test repeatability and reproducibility. Participants to the workshop agreed that more **guidance and improved testing descriptions are needed.**

Session 4. Safety strategies; methods for detecting, mitigating and preventing thermal propagation; anti-cascading strategies

Upon TR of a single cell, extreme convective and radiation heat is being produced, high temperatures (up to 700-1200 °C) as well as possibly open flames and ejection of toxic and flammable gases occur. In order to avoid a cell to cell propagation, risk mitigation measures need to be implemented. In current commercial batteries a wide range of cells, cell types and pack designs are used. Up to today, no single approach towards mitigating thermal propagation has been identified and as a consequence a wide range of different battery pack design solutions are available. It seems improbable that a single approach will be found, at least in the near future. Instead, a range of different measures is typically combined for achieving a sufficient level of safety.

Such protection strategies have to take into consideration the level of applicability of a single measure: from cell, module, pack, battery management system, containment, application (e.g. passenger cars, commercial cargo, stationary applications) to environment/infrastructure/emergency services, etc. (see **Figure 5**).

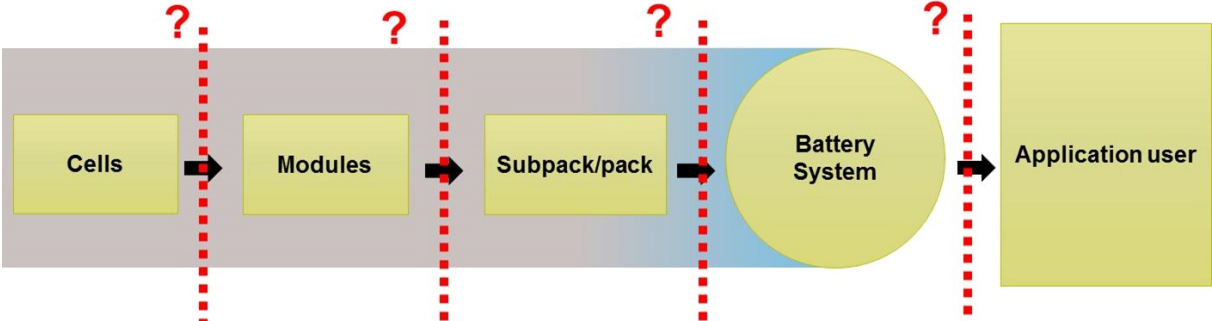

Figure 5. Different levels of a battery system which are relevant for mitigating risk related to thermal propagation. Reprint from ⁷ and reference [41]

A series of mitigation strategies were proposed by the different speakers (Table 1).

Table 1. List of mitigation strategies as mentioned by several presenters ^[3,11,15-17]

Mitigation strategy	Effect towards TP
Modified separators (e.g. PE, PP/PE/PP, PE-based with ceramic coating/particles). Shutdown separators	Rise the TR trigger temperature (T_{onset}) by avoiding short circuit caused by separator failure Minimum thermal shrinkage of the separator
Modified electrolyte (non-flammable or less flammable electrolytes)	Avoiding flammability limits heat generation (and potentially further damage)
All-solid-state batteries	No to lower risk of fire/explosion (no

¹⁵ C. Middendorf (3M) presentation: "Design concepts and materials for thermal propagation prevention". Online access: <https://ec.europa.eu/jrc/sites/jrcsh/files/concepts-materials-thermal-propagation-prevention.pdf>

¹⁶ W. Prochazka (AVL) presentation: "Cost and performance penalty of thermal propagation mitigation and venting measures". Online access: <https://ec.europa.eu/jrc/sites/jrcsh/files/wenzel-prochazka-cost-performance-penalty-thermal-propagation-mitigation-venting-measures.pdf>

¹⁷ P. Kritzer (Freudenberg) presentation: "Preventing thermal propagation – approaches & effort to implement them in a battery system". Online access: <https://ec.europa.eu/jrc/sites/jrcsh/files/preventing-thermal-propagation-battery-system.pdf>

Mitigation strategy	Effect towards TP
	liquid/flammable electrolytes)
Electric fuses (<i>e.g.</i> wire bonding)	Reduce the released electric energy during an ISC
Incorporation of materials with increased thermal capacity (<i>e.g.</i> phase change materials, endothermic filler materials)	Increase heat dissipation. Cooling effect due to phase change
High performance insulation materials between cells/modules (<i>e.g.</i> fire walls/thermal barriers, ceramic materials resistant to high temperatures, flame retardant barriers/sheets such as Nextel™ ceramic textile or intumescent materials which swell/expand as a result of exposure to heat, expanding coatings, heat shields)	Increase thermal resistance between cells/modules Thermal energy transfer to neighbouring cells is minimised
Physical separation between cells and/or components	Increase thermal resistance
Vaporising runaway shields	Increase thermal resistance and cooling effect during vaporisation of liquid
Defined breaking/venting points	Protect neighbouring cells from cell ejecta (vented gases, solids, liquids) and circulating currents Reduced risk of side wall ruptures
Directing/channelling venting (less efficient for pouch cells) Provide tortuous path for the ejecta	Heat carried by vent gases is removed in a controlled way; inflammation of vent gases can potentially be avoided which reduces heat introduced to certain cells
Venting valve with limited back-mixing	Limit amount of available oxygen and thereby released energy
Vents with flame arresting screens	Prevent flames and sparks exiting the battery pack enclosure
Bottom vent designs (low pressure burst)	Residence time of reacting material is reduced (less violent TR events)
Heat path-heat conductors	Lowers temperature exposure to adjacent cells
Thermal management system (<i>e.g.</i> cooling plates/emergency cooling)	Heat removal through cooling can delay or avoid propagation

Mitigation strategy	Effect towards TP
Oxygen starvation (e.g. overpressure valves with limited back-mixing)	Fast removal of the exhaust gases (e.g. > 40 l/sec @ 50 mbar) Limited re-entrance of oxygen from outside
Inert gas battery system (e.g. pressure compensation element-breathable pack)	No ingress of oxygen from battery environment No additional oxidation after TR No contamination/water vapour can enter battery during normal operation (no condensation) Drawback: sealed battery housings would require thick walls, which makes this option not viable

The use of non-flammable electrolytes constitutes, in principle, an efficient approach towards TP mitigation. However, experiments performed in 20 Ah pouch cells using the wax based implantable device could not validate this approach¹⁰. Two cells, one having standard electrolyte, and another one having an electrolyte denoted as non-flammable, developed into TR with smoke and fire. Actually the cell containing the non-flammable electrolyte showed TR at a shorter time (20 min compared to 1.5 h) and produced higher temperatures (350 °C compared to ~260 °C) than the cell containing the conventional flammable electrolyte. These results demonstrate that the impact on safety performance of using electrolytes optimised with respect to flammability has to be evaluated carefully.

It needs to be mentioned that non-flammable electrolytes may be problematic when fluorine is a main constituent to protect against (external) fire based on two aspects: *i*) extra HF gas being released and *ii*) fluorinated organic compounds have a potential to produce more heat during TR compared to typical organic compounds used in Li-ion batteries (e.g. comparing enthalpy of formation: 2 LiF vs. Li₂O).



In general, larger distance between cells (with or without insulation materials) leads to lower temperatures for the neighbouring cells in case of TR¹⁵. Direct contact between cells nearly assures propagation³. As a general rule, the spacing/distance between the cells is inversely proportional to the effectiveness of heat propagation path³. Therefore, one design parameter of relevance is the **space gap between the cells**. However, if a major heat transfer occurs via infrared radiation at high temperature, air-gap may not be effective. For 18650 cells based on LCO chemistry results were presented⁹. In the case of 1s10p arrangement complete propagation was still observed despite the space

introduced between the cells. However, a significant impact was observed for the 10s1p arrangement. In this case no propagation was observed, whereas when no spacer was used propagation TP was observed in some cases. Initiated cell reached temperatures above 600 °C and neighbouring cells remained below 300 °C without going into TR. The air gap introduced with this design allowed for heat to dissipate quickly, eliminating the risk of TP.



The use of **heat sinks** has also been presented⁹. 5 pouch cells (3 Ah, LCO) were arranged in a small string/module. One of the cells situated in the exterior of the module was initiated into TR by nail penetration along the longitudinal axis of the cell. The effect of aluminium or copper spacers between the cells was studied. When no spacer is used, full cell

to cell propagation was observed after just over 1 min, with temperatures approaching 700 °C. The addition of aluminium spacers showed limited propagation in the string, in the case of using 1.6 mm spacer there was visible propagation between the initiated cell and its neighbour, however 3.2 mm spacer inhibited any propagation. When using a significantly thinner spacer (0.8 mm) complete propagation through the module was observed ~ 4 min after TR initiation. In the case of using a copper spacer instead of aluminium, similar results were obtained. On this set of experiments the cumulative heat flux was measured leading to the following values:

Cell with no spacer = 98 kW/m² (No TP), cell +0.8 mm Al spacer = 27 kW/m² (No TP), cell +0.8 mm Al spacer = 27 kW/m² (TP), cell +1.6 mm Al spacer = 15 kW/m², cell + 3.2 mm Al spacer = 11 kW/m² (TP).

Comparison of 2 interstitial heat sinks was done by a presenter³: aluminium interstitial and vaporising interstitial (composed of highly conductive carbon fibre wick). This comparison was carried out on a cylindrical cells (LG MJ1) based module. The vaporising interstitial option brings a 19 % improvement in the weight (Wh/kg). TR was initiated using 3 initiation methods (interior, top and bottom heating) leading to a maximum increase in temperature of 40-63 °C and no propagation through the module.

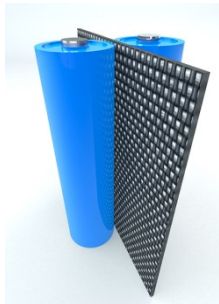

In principle any insulation material needs to be:

- compressible (supporting dimensional changes of the cell)
- sufficiently tough
- in shape also when exposed to high temperatures
- stable, without contributing to the decomposition reaction (e.g. does not contain organic matter)
- light and relatively thin

Intumescent materials (which swell as a result of exposure to heat) are typically used in passive fire protection (help avoiding convection and provides insulation). Some design parameters of intumescent materials are: activation temperature (150 to 350 °C), uniaxial or multiaxial expansion, factor of volume expansion (3x to 15x) and type of product (mat, film or coating). The use of intumescent materials seems to be a promising solution¹⁵.

The effect that the **insulation material** thickness has on the TP was also investigated using Openmodelica¹². Modelling results indicate that when no spacer is used, complete cell-to-cell propagation occurs; however in the modelled situation an only 1 mm thick mica sheet is able to stop the propagation.

The effect of different **firewall thicknesses** was investigated: 0 (no firewall present), 5, 10 and 20 mm. For the lowest thickness tested the temperature reached by the neighbouring cell falls just below the 100 °C limit set after 20 min of TR initiation. Increasing the wall thickness results on lower cell temperatures as can be anticipated.

A similar experiment was conducted by another presenter on a small module (2s1p) with 2.5 Ah 18650 cells based on NCA chemistry¹¹. Nail penetration was used as initiation method. An **isolation plate** was placed in between the two cells along with the external cell connectors. Temperatures > 400 °C were recorded for the initiated cell, with almost no temperature rise for the neighbouring cell, demonstrating the effectiveness of the isolation plate.

When using a 1 mm **heat shield**¹⁷ (silicone-based rubber) the temperature of neighboring cells was reduced from 600 °C to 200 °C after 30 s of heat exposure to an initiated cell. Due to its elasticity, this type of heat shield may be integrated in the gasket for the overpressure release channel.

An example where several mitigation strategies were implemented was presented on a 65 cells module (13P5S)³ having a total 37 Ah capacity:

- Aluminium interstitial heat sink to minimise the side wall rupture
- A mica paper sleeve on each cell to avoid cell to cell contact (0.5 mm spacing)
- A 12 A fusible link to individually fuse cells in parallel
- Ceramic bushing lining cell vent opening to protect adjacent cells from TR ejecta
- Flame arresting vent ports to provide tortuous path with flame arresting screens

The design presented renders a 1.4 parasitic mass factor. Attempts to drive TR with a bottom cell heater were unsuccessful, and cells could only be heated up to < 100 °C as heat generated from trigger cell is quickly dispersed and shared amongst the other adjacent cells.

Design strategies at module level can also be implemented, in order to avoid module to module propagation (e.g. MICA plates between modules)¹⁶.

In another study⁷ a symmetric part of a battery pack was simulated via finite-element method (FEM) in COMSOL and fire dynamics simulator (FDS). A **firewall material between modules** was considered and 1 mm Al-plate cooling plates on one side of the cell. The cell used for the calculations was an EiG 7 Ah carbon/LFP pouch cell [42]. The protection/mitigation strategies implemented by **cooling plates** every 2 cells, appropriate cell spacing, cooling-forced convection and use of fire walls between modules hinders cell-to-cell propagation. However, the model does not consider heat transfer through the electrical connections between the battery cells, which can have an impact on the cell-to-cell propagation.



An **Emergency Cooling Concept** was presented¹⁷ that uses pressurised CO₂ (probable medium of future mobile air conditioning systems) when a cell becomes overheated [43]. This concept was proven to operate successfully on a stack of 4 pouch cells (4 Ah per cell). However it is a rather complex system.

From a practical point of view, three EVs types of packs were presented and their strategies towards TP were discussed¹⁶: Tesla Model X, Chevrolet Bolt and Mitsubishi Outlander PHEV. The Tesla Model X battery, composed of 18650 cylindrical cells, uses polycarbonate isolation stripes (0.3 mm) and a 1 mm cooling pipe between the cells within each module. Also 15 fluorosilicone venting plugs (530 mm²) to force venting out towards the sides of the battery pack are in place. The Chevrolet Bolt uses a 2.1 mm compression pad/foam and a 0.5 mm aluminium cartridge cover between the cells and 4 pressure equalisation and venting membranes (289 mm²) in the pack to direct the venting to the sides (between the doors). Finally, the Mitsubishi Outlander uses 2.3 mm spacers between the cells and 3 pressure equalisation and venting membranes (72 mm²).

Session 5. Cost and performance penalty of mitigating thermal propagation

Considering the risks associated with thermal propagation in large batteries, it seems reasonable to introduce measures or functions for mitigating thermal propagation. However, this unavoidably comes with a direct cost and performance penalty (e.g. in terms of weight, volume and cost of the added component, higher assembly cost due to increased system complexity) as well as an indirect cost (e.g. lower energy density of the battery system leading to lower range of an EV due to a fixed available volume; higher system complexity might also lead to more frequent failures and higher effort for repairs).

In modern battery systems many components integrate multiple functions (e.g. a separator between cells could contribute to heat conduction, but also to compensation of cell expansion or mechanical integrity). This makes it more difficult to assign a specific penalty to the function contributing to mitigation of thermal propagation. Further-as also discussed in **Session 4**-typically a set of functions at different levels of the battery is applied for mitigating risks linked to thermal propagation, which further complicates the definition of a specific cost for mitigation of propagation.

In the workshop, examples for the measures implemented in different currently available electric vehicle packs utilising cells with different casing were given¹⁶: a certain distance between adjacent cells (with or without additional filler material such as polycarbonate or a compression pad from foam) was found in all shown cases. Also between modules and between pack and vehicle there is the option of putting an additional insulating layer. A simple calculation¹⁸ assuming prismatic cells with dimensions x, y, z , a uniform distance between cells, d , and a cell-level volumetric energy density, σ_{cell} [Wh/m³], results in the effective volumetric energy density σ_{eff} of:

$$\sigma_{\text{eff}} = \sigma_{\text{cell}} \frac{x y z}{(x + d)(y + d)(z + d)}$$

Assuming reasonable dimensions for a prismatic cell e.g. $x = 20 \text{ cm}$, $y = 10 \text{ cm}$, $z = 5 \text{ cm}$, **Figure 6** shows the dependence of volumetric energy density on distance between the cells. It becomes immediately clear that introducing a distance between cells leads to a relevant reduction of energy density and therefore has to be carefully balanced with safety requirements.

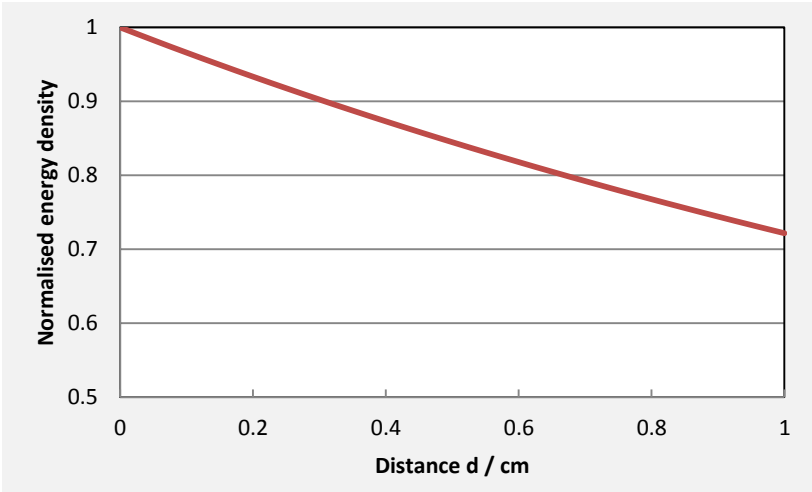

Figure 6. Normalised volumetric energy density vs. cell to cell distance (assuming prismatic cells with dimensions of 20 cm x 10 cm x 5 cm) [own calculation]

¹⁸ In the calculation, one distance d per cell is assumed in all direction (i.e. this might not be representative for the edges of a real module or pack).

Further, venting strategies for different packs were compared (e.g. wrt. number of vent openings and overall venting cross-section).

Several concrete examples for additional cost were mentioned: the cost of cell to cell ceramic insulation material amounts to about 10 % of module cost excluding cells (15 % for intumescent material). The overall additional cost for the mitigation measured in the Tesla Model X are estimated to about 15 % of housing frame cost at pack level.

It must be concluded that the right balance between acceptable level of risk and cost for mitigation measures must be sought specifically for every application. For this purpose it is crucial to perform a thorough analysis of safety risks (e.g. applying FMEA) and select the most suitable risk mitigation measures (see **Session 4**) potentially at different levels (cell, module, pack and beyond).

Session 6. Impact of avoiding thermal propagation on the current safety testing landscape

Battery systems can be designed to avoid thermal propagation by containing failure of one cell to a 'graceful failure' at a certain cost. Assuming that a test is available that once passed-reliably indicates prevention of thermal propagation in a certain battery, one can ask if other safety tests might become obsolete.

It should be noted that thermal propagation testing is addressed in an increasing number of standards (e.g. SAE J2464 [20], UL 2580 [29], UL 9540A [44], UL 1973 [45], IEC 62619 [21]), but no consolidated approach has been developed yet. Several standards specifically show a shift of focus from prevention to measurement and reduction of severity. Nevertheless, it seems reasonable to speculate about having a fit-for-purpose thermal propagation test available (e.g. for a certain type of application/chemistry/design). Under this assumption, it was the ambitious (and partially provocative) target of this workshop session to assess if some battery safety tests which are currently typically performed might become obsolete.

Based on the presenters' assessment of the current standardisation landscape^(8,19), in order to have a robust TP test, which covers credible worst-case scenarios, more work is needed on:

- The selection of location of trigger cell
- The choice of method to initiate thermal runaway in trigger cell
- The role of the energy introduced by each initiation method
- The detection of TR
- The pass/fail criteria
- The handling of emitted gases
- The number of test repetitions for statistical validity

It was stated that 'most experts admit that a single cell failure, while highly improbable, cannot be completely eliminated' and current safety design efforts and measures aim at reducing its severity⁸.

While no concrete suggestions were made for battery safety tests that will not be required any more if a battery pack is tolerant to a single cell TR, it was suggested that⁸:

- It might be possible to reduce levels of acceptance testing, such as:
 - Incoming inspection
 - Leak testing
- Less attention might be required to efforts aimed at reducing the probability of a cell failure, such as:
 - Less frequent manufacture inspection
 - Audits of production line
 - More accepting of cell design modifications
- A relaxation of installation requirements of stationary energy storage in buildings

No agreement was reached on these suggestions, though, and several presenters showed divergence with it. Further work on the definition of fit-for-purpose propagation tests and a better understanding of the impact of verified battery pack designs that avoid thermal propagation is required. The development of advanced diagnostic tools for non-destructive design verification can help loosen the requirements at pack level.

¹⁹ T. Timke (Solarwatt) presentation: "Current and future propagation tests and the embedding in product safety". Online Access: https://ec.europa.eu/jrc/sites/jrcsh/files/thomas-timke_current-future-propagation-tests-product-safety_.pdf

Conclusions and recommendations

It is common understanding that a severe single cell TR failure in a battery system, while rather improbable, cannot be completely eliminated. Nevertheless there is a clear need for reliable batteries and components ('carefree solution'). As a consequence, such scenarios should be addressed when evaluating battery safety. One approach for assessing related risks further is a thermal propagation test.

Below a summary of conclusions and recommendations can be found based on the discussions taken place at the workshop:

- Definitions and terminology

There was general agreement about the need for a harmonised definition of thermal runaway. Possible criteria for such definition include: temperature increase rate, occurrence of venting, fraction of converted energy of overall cell's chemical energy content. A more detailed understanding of the mechanisms of thermal runaway might make also feasible to have several sub-definitions for discriminating between different types of thermal runaway.

- Thermal propagation testing and standardisation needs

As there is no single, clearly defined single cell TR failure scenario, it seems most useful to develop a thermal propagation test of general robustness versus a single cell thermal runaway test. No reliable and practical method exists to create on-demand internal shorts in Li-ion cells (single cell failure) that produce a response that mimics field failures. Heating is the initiation method suggested in most standards, but at the same time there is a potentially strong influence of the utilised initiation method on the outcome of the TP thermal propagation test. Therefore the selection of a suitable initiation method is crucial (e.g. 'typical credible and reproducible thermal runaway initiation' is required in Sandia 2017-6925 [46] and the 'worst case credible thermal runaway event' in NASA JSC 20793 [47]). Besides the scenario starting for a single cell failure, other scenarios include multiple cell failure (due to e.g. BMS failure, mechanical crash), and the TR propagation from such scenario may be more difficult than from a single cell, however, propagation protection and testing may be important.

There is agreement that further pre-normative research is required to develop fit-for-purpose testing methods and standards. In this context there is also the need to address the question on which level (cell, module, pack, complete product) a test can and should be performed in order to provide representative results for assessing safety in the actual application.

- Testing parameters, comparability and reproducibility of testing

There has been identified a wide variability in the pass/fail criteria requirements in various standards (IEC 62619 [21]: no fire outside the system, VDE AR 2510-50 [48]: no fire, no explosion, no leakage, SAE J2464 [20]: no pass/fail Criteria, UL 1973 [45]: no fire outside), which does not favour comparability of testing.

Another important consideration concerns the significance of the outcome of a thermal propagation test: whether propagation occurs depends mainly on the difference between heat introduced in and heat removed from a neighbouring cell. From a statistical point of view, this is a difficult situation as a relatively small change in heat flow (in or out) can change the test outcome. Consequently, it must be evaluated carefully how often a test needs to be repeated to receive a reliable test result and thereby a relevant confirmation of a certain level of safety.

Even though many standardisation efforts have been on-going in the recent past, current standards still typically allow for different initiation methods and test details (e.g. location of initiation cell) are not always defined. Further work is

required to define standardised abuse testing methods regarding thermal propagation.

- Gas and toxicity consideration

More information on physico-chemical properties and behaviour of vented gas during thermal runaway and propagation are necessary. Such information is not only relevant for understanding the energy transfer during thermal propagation, but also to assess risks that *e.g.* first responders or firefighters would encounter in severe battery safety events. Other areas for further research are the impact of oxygen availability inside the battery enclosure and the effect of ignition of exhaust gases on thermal propagation. It still remains unclear if an external spark source should be applied during thermal propagation testing as spark sources are additional risk scenarios and impose additional technical hurdles, but may be representative of a realistic scenario.

- Impact of aged systems

It is a common challenge for product developers, that even shorter battery development cycles are required to be competitive in a fast changing market. At the same time the long-term reliability of offered products must be ensured. In battery abuse tests, big differences in test outcomes have been observed-while not consistently-between EOL and BOL cells. Therefore thermal propagation testing seems also advisable on aged systems also in view of potential second use scenarios. On the other hand, such tests are difficult to realise within the rather short development cycles and lead to extra costs.

- Simulation and modelling

Progress in modelling has made simulation of abuse testing more representative of real tests and thereby more relevant. Modelling efforts can support thermal propagation testing (*e.g.* for selection of an initiation cell).

- Early detection tools

There is a need for more accurate and faster early detection tools, which could allow control of certain safety events at an even earlier stage (*i.e.* before thermal runaway occurs). Further research efforts in this direction seem justified and promising.

- Mitigation approaches

There is a general belief that some cathode materials are 'safer' than others; however an overall safety assessment is required.

Solid state batteries (SSB) may change the game with respect to safety: as there is no longer any liquid flammable electrolyte. However, rapid reactions are favoured between sulphur and lithium (candidate materials for SSB) and other hazards will become apparent, such as fusion of cells, hindered thermal energy dissipation, etc. so the risk of TP might not be fully eliminated

Many other developments also might help reducing the consequences or eliminating the actual occurrence of TR in conventional LIBs in terms of electrode/electrolyte composition, separator characteristics, use of thermally resistant materials, etc. In this context, it might be considered unfair requiring TP testing for 'safe' cells, therefore an exception for benign cells is suggested: if TR cannot be initiated ('no catastrophic failure mode'), this should be considered as a positive outcome of the test (*e.g.* several initiation methods could be defined, if none lead to TR, test is passed).

The mitigation of risks related to thermal propagation requires a holistic view of cell, module, pack and application. Defining measures on one level-independent of the other levels-may lead to high cost and/or limited increase in safety.

Nevertheless for the near and medium term avoiding thermal propagation will be a key challenge for making Li-ion battery systems safer and the development of suitable tests is of high importance.

References

- [1] COM(2016) 763 final. "Communication on Accelerating Clean Energy Innovation". Communication from the European Commission to the European Parliament, the Council, the European Economic and Social Committee, the Committee of the Regions and the European Investment Plan, (2016).
- [2] D. Lisbona, T. Snee, A review of hazards associated with primary lithium and lithium-ion batteries, *Process Safety and Environmental Protection*, 89 (2011) 434-442.
- [3] Chapter Six - Electrochemical-Thermal Characterization and Thermal Modeling for Batteries, in: L.M. Rodriguez-Martinez, N. Omar (Eds.) *Emerging Nanotechnologies in Rechargeable Energy Storage Systems*, Elsevier, Boston, 2017, pp. 195-229.
- [4] Contributors, *Emerging Nanotechnologies in Rechargeable Energy Storage Systems*, Elsevier, Boston, 2017, pp. ix-xi.
- [5] F. Larsson, P. Andersson, P. Blomqvist, B.-E. Mellander, Toxic fluoride gas emissions from lithium-ion battery fires, *Scientific Reports*, 7 (2017) 10018.
- [6] N.P. Lebedeva, L. Boon-Brett, Considerations on the Chemical Toxicity of Contemporary Li-Ion Battery Electrolytes and Their Components, *Journal of the Electrochemical Society*, 163 (2016) A821-A830.
- [7] *Lithium-Ion Batteries, Safety*, in: R.J. Brodd (Ed.) *Batteries for Sustainability*, Springer, New York, 2012, pp. 285-318.
- [8] M. Jacoby, Burning Batteries, *Chemical & Engineering News, C&EN, Chemical & Engineering news*, 85 (2007) 26-28.
- [9] T.H. Dubaniewicz, J.P. DuCarme, Are Lithium Ion Cells Intrinsically Safe?, *Industry Applications Society Annual Meeting (IAS), IEEE* (2012) 1-10.
- [10] K.F. Yeow, H. Teng, Characterizing thermal runaway of lithium-ion cells in a battery system using finite element analysis approach, *SAE International Journal of Alternative Powertrains*, 2 (2013) 179-186.
- [11] D.P. Finegan, M. Scheel, J.B. Robinson, B. Tjaden, M. Di Michiel, G. Hinds, D.J.L. Brett, P.R. Shearing, Investigating lithium-ion battery materials during overcharge-induced thermal runaway: An operando and multi-scale X-ray CT study, *Physical Chemistry Chemical Physics*, 18 (2016) 30912-30919.
- [12] A.W. Golubkov, D. Fuchs, J. Wagner, H. Wiltsche, C. Stangl, G. Fauler, G. Voitic, A. Thaler, V. Hacker, Thermal-runaway experiments on consumer Li-ion batteries with metal-oxide and olivin-type cathodes, *RSC Advances*, 4 (2014) 3633-3642.
- [13] T.D. Hatchard, S. Trussler, J.R. Dahn, Building a "smart nail" for penetration tests on Li-ion cells, *Journal of Power Sources*, 247 (2014) 821-823.
- [14] C.J. Orendorff, E.P. Roth, G. Nagasubramanian, Experimental triggers for internal short circuits in lithium-ion cells, *Journal of Power Sources*, 196 (2011) 6554-6558.
- [15] IEC 62133-2: Secondary cells and batteries containing alkaline or other non-acid electrolytes - Safety requirements for portable sealed secondary cells, and for batteries made from them, for use in portable applications. Part 2: Lithium systems, (2017).
- [16] IEC TR 62914: Secondary cells and batteries containing alkaline or other non-acid electrolytes - Experimental procedure for the forced internal short-circuit test of IEC 62133:2012, (2014).
- [17] IEC TR 62660-4: Rechargeable Cells Standards Publication Secondary lithium-ion cells for the propulsion of electric road vehicles. Part 4 : Candidate alternative test methods for the internal short circuit test of IEC 62660-3, (2017).
- [18] UL1973 Second edition: Standard for batteries for use in light electric rail (LER) applications and stationary applications (2017).

- [19] V. Ruiz, A. Pfrang, A. Kriston, N. Omar, P. Van den Bossche, L. Boon-Brett, A review of international abuse testing standards and regulations for lithium ion batteries in electric and hybrid electric vehicles, *Renewable and Sustainable Energy Reviews*, 81 (2017) 1427-1452.
- [20] SAE J2464: Electric and Hybrid Electric Vehicle Rechargeable Energy Storage System (RESS) Safety and Abuse Testing, (2009).
- [21] IEC 62619: Secondary cells and batteries containing alkaline or other non-acid electrolytes - Safety requirements for large format secondary lithium cells and batteries for use in industrial applications, (2017).
- [22] IEC 62660-3: Rechargeable Cells Standards Publication Secondary lithium-ion cells for the propulsion of electric road vehicles. Part 3 : Safety requirements of cells and modules, (2016).
- [23] RTCA DO -311: Minimum operational performance standards for rechargeable lithium battery systems, (2008).
- [24] F. Larsson, S. Bertilsson, M. Furlani, I. Albinsson, B.E. Mellander, Gas explosions and thermal runaways during external heating abuse of commercial lithium-ion graphite-LiCoO₂ cells at different levels of ageing, *Journal of Power Sources*, 373 (2018) 220-231.
- [25] M. Keyser, E. Darcy, D. Long, A. Pesaran, Passive Safety Device and Internal Short Tested Method for Energy Storage Cells and Systems, US patent 9,142,829, USA, 2013.
- [26] J. Lamb, C.J. Orendorff, Evaluation of mechanical abuse techniques in lithium ion batteries, *Journal of Power Sources*, 247 (2014) 189-196.
- [27] 2018, United Nations Economic Commission for Europe. Global Technical Regulation on the Electric Vehicle Safety (EVS) (*Phase I*), <https://www.unece.org/fileadmin/DAM/trans/main/wp29/wp29wgs/wp29gen/wp29registry/ECE-TRANS-180a20e.pdf>.
- [28] SAE AS6413: Performance based package standard for lithium batteries as cargo on aircraft. Work in Progress (WIP), SAE International, <http://standards.sae.org/wip/as6413/>.
- [29] UL 2580: Batteries for Use in Electric Vehicles, (2013).
- [30] Safety of Rechargeable Energy Storage Systems with a focus on Li-ion Technology, in: L.M. Rodriguez-Martinez, N. Omar (Eds.) *Emerging Nanotechnologies in Rechargeable Energy Storage Systems*, Elsevier, Boston, 2017, pp. 253-290.
- [31] D.H. Doughty, C.C. Crafts, SAND 2005-3123: FreeDomCAR electrical energy storage systems abuse test manual for electric and hybrid electric vehicle applications, (2005).
- [32] ISO 12405-3: Electrically propelled road vehicles - Test specification for lithium-ion traction battery packs and systems. Part 3: Safety performance requirements, (2014).
- [33] A. Lecocq, M. Bertana, B.Truchot, G. Marlair, 2012, International Conference on Fires In Vehicles - FIVE 2012Chicago, United States, 2012, pp. 183-194.
- [34] F. Colella, G. Rein, V. Verda, R. Borchiellini, Multiscale modeling of transient flows from fire and ventilation in long tunnels, *Computers & Fluids*, 51 (2011) 16-29.
- [35] P.T. Coman, S. Rayman, R.E. White, A lumped model of venting during thermal runaway in a cylindrical Lithium Cobalt Oxide lithium-ion cell, *Journal of Power Sources*, 307 (2016) 56-62.
- [36] AIS-048: Battery Operated Vehicles - Safety Requirements of Traction Batteries, (2009).
- [37] QC/T 743: Lithium – ion batteries for electric vehicles. Chinese voluntary standards for automobiles, (2006).

- [38] H.P. Jones, J.T. Chapin, M. Tabaddor, 2010, European Space Agency, (Special Publication) ESA SP. 4th IAASS Conference 'Making Safety Matter', 2010.
- [39] D.P. Finegan, E. Darcy, M. Keyser, B. Tjaden, T.M.M. Heenan, R. Jervis, J.J. Bailey, R. Malik, N.T. Vo, O.V. Magdysyuk, R. Atwood, M. Drakopoulos, M. DiMichiel, A. Rack, G. Hinds, D.J.L. Brett, P.R. Shearing, Characterising thermal runaway within lithium-ion cells by inducing and monitoring internal short circuits, *Energy & Environmental Science*, 10 (2017) 1377-1388.
- [40] M. Zhang, J. Du, L. Liu, A. Stefanopoulou, J. Siegel, L. Lu, X. He, X. Xie, M. Ouyang, Internal Short Circuit Trigger Method for Lithium-Ion Battery Based on Shape Memory Alloy, *Journal of the Electrochemical Society*, 164 (2017) A3038-A3044.
- [41] F. Larsson, Lithium-ion Battery Safety-Assessment by Abuse Testing, Fluoride Gas Emissions and Fire Propagation, Department of Physics, Chalmers University of Technology, Göteborg, Sweden, 2017
- [42] F. Larsson, J. Anderson, P. Andersson, B.E. Mellander, Thermal modelling of cell-to-cell fire propagation and cascading thermal runaway failure effects for lithium-ion battery cells and modules using fire walls, *Journal of the Electrochemical Society*, 163 (2016) A2854-A2865.
- [43] P. Kritzer, H. Döring, B. Emmermacher, Improved Safety for Automotive Lithium Batteries: An Innovative Approach to include an Emergency Cooling Element, 2014.
- [44] UL 9540A: Test Method for Evaluating Thermal Runaway Fire Propagation in Battery Energy Storage Systems, (2018).
- [45] UL 1973: Standard for Batteries for Use in Stationary, Vehicle Auxiliary Power and Light Electric Rail (LER) Applications, (2018).
- [46] SAND2017-6925: Recommended Practices for Abuse Testing Rechargeable Energy Storage Systems (REESSs), (2017).
- [47] JSC-20793 Rev D: Crewed space vehicle battery safety requirements, (2017).
- [48] VDE-AR-E 2510-50: Stationary battery energy storage systems with lithium batteries - Safety requirements, (2017).

List of abbreviations and definitions

ARC	Accelerating rate calorimeter
BMS	Battery management system
BOL	Begin of life
CC-CV	Constant current-constant voltage
CFD	Computational fluid dynamics
EOL	End of life
EVS	Electric vehicle safety
EUCAR	European council for automotive research & development
GTR	Global technical regulation
HF	Hydrogen fluoride
HRR	Heat release rate
ICP	Inductively coupled plasma
IDL	Immediately dangerous to life
ISC	Internal short circuit
MAS	Magic angle spinning
LFP	Lithium iron phosphate
LIBs	Lithium ion batteries
LCO	Lithium cobalt oxide
LNMO	Lithium nickel manganese oxide
NMC	Nickel manganese cobalt oxide
NMR	Nuclear magnetic resonance
PVDF	Polyvinylidene fluoride
SEI	Solid electrolyte interphase
SEM-FIB	Focussed ion beam scanning electron microscopy
SOC	State of charge
SOH	State of health
SSB	Solid state batteries
TGA	Thermogravimetric analysis
TP	Thermal propagation
TR	Thermal runaway

List of figures

Figure 1. Typical evolution of thermal runaway in a Li-ion cell. The scales are given in arbitrary units and the reactions shown separately may occur simultaneously. Reprint from [30] 6

Figure 2. Schematic representation of a pressure curve inside the autoclave chamber during a thermal runaway event as presented by ² 8

Figure 3. Example of pouch cell holder suitable for heating initiation method. Reprint from ¹²22

Figure 4. Possible TR and TP testing sequence25

Figure 5. Different levels of a battery system which are relevant for mitigating risk related to thermal propagation. Reprint from ⁷ and reference [41]26

Figure 6. Normalised volumetric energy density vs. cell to cell distance (assuming prismatic cells with dimensions of 20 cm x 10 cm x 5 cm) [own calculation]31

List of tables

Table 1. List of mitigation strategies as mentioned by several presenters ^[3,11,-]26

Annexes

Annex 1. Programme

DAY ONE (8 March 2018)	
8:15-8:40	Registration: building 325
8:40-8:50	Welcome and opening: Piotr Szymanski. JRC Petten Site Director Introduction to the workshop: Andreas Pfrang. Project Leader BaTProp, JRC, C.1. Energy Storage Unit
Session 1. THERMAL RUNAWAY: MECHANISMS AND INFLUENCING FACTORS	
8:50-9:20	<i>Session Chairman and Keynote Presenter:</i> S. Scharner. Technical Specialist. Advanced Development – Requirements and Concepts in Battery Cell Technology. BMW group. QUANTITATIVE SAFETY CHARACTERIZATION OF LI-ION CELLS (30 min) <i>Rapporteur:</i> A. Kriston (JRC, C.1. Energy Storage Unit)
9:20-9:40	<ul style="list-style-type: none">M. Börner. Researcher, University of Münster MEET Battery Research Center. FACTORS INFLUENCING THE THERMAL STABILITY OF LI-ION BATTERIES – FROM ACTIVE MATERIALS TO STATE-OF-CHARGE AND DEGRADATION (20 min)
9:40-10:00	<ul style="list-style-type: none">C. Chanson. General Manager. RECHARGE. CHARACTERIZE THE LITHIUM BATTERIES THERMAL RUN-AWAY REACTION (20 min)
10:00-10:20	<ul style="list-style-type: none">Open discussion (20 min)
10:20-10:50 Coffee break (building 325 hall)	
Session 2. THERMAL PROPAGATION	
10:50-11:20	<i>Session Chairman and Keynote Presenter:</i> Fredrik Larsson, Researcher, RISE Research Institutes of Sweden, Safety and Transport, Electronics, Sweden. THERMAL PROPAGATION IN LITHIUM-ION BATTERIES (30 min) <i>Rapporteur:</i> E. Napolitano (JRC, C.1. Energy Storage Unit)
11:20-11:40	<ul style="list-style-type: none">E. Kolp. Researcher, Technical University of Munich (TUM). Department of Electrical and Computer Engineering. THERMAL MODELLING OF THERMAL RUNAWAY PROPAGATION IN LITHIUM-ION BATTERY SYSTEMS (20 min)
11:40-12:00	<ul style="list-style-type: none">C. Orendorff. Battery Abuse Testing Lab, Sandia National laboratories. FUNDAMENTALS OF FAILURE PROPAGATION IN LITHIUM-ION BATTERIES (20 min)
12:00-12:20	<ul style="list-style-type: none">Open discussion (20 min)
12:20-13:20 Lunch break (building 325 hall)-group picture	

DAY ONE (8 March 2018)**Meeting room: building 325 – 101 (1st floor)****Session 3. THERMAL RUNAWAY INITIATION METHODS, FIT-FOR-PURPOSE TESTING RELATED TO EXTERNAL AND INTERNAL ABUSE TRIGGERS**

13:20-13:35 *Session Chairman and Keynote Presenter:* P. Coman. Independent researcher. [INTRODUCTION TO BATTERY THERMAL RUNAWAY TESTING METHODS, FROM SINGLE CELLS TO PACKS](#) (15 min)

Rapporteur: M. Bielewski (JRC, C.1. Energy Storage Unit)

13:35-13:55 • H. Döring. Head of Department Accumulators, Zentrum für Sonnenenergie-und Wasserstoff-Forschung Baden-Württemberg (ZSW), Ulm, Germany. [INITIALIZING OF THERMAL RUNAWAY FOR LITHIUM-ION CELLS FOCUSING ON THE EFFECT OF INTERNAL SHORT CIRCUIT](#) (20 min)

13:55-14:15 • A. Golubkov. Researcher. Virtual Vehicle. [INITIATION OF THERMAL RUNAWAY WITH DIFFERENT HEATING DEVICES](#) (20 min)

14:15-14:35 • M. Keyser. Vehicle electrification group lead. National Renewable Energy Laboratory (NREL) [NREL/NASA INTERNAL SHORT CIRCUIT INSTIGATOR IN LITHIUM ION CELLS](#) (20 min)

14:35-15:05 • Open discussion (30 min)

15:05-15:30 *Coffee break (building 325 hall)*

Session 4. SAFETY STRATEGIES; METHODS FOR DETECTING, MITIGATING AND PREVENTING THERMAL PROPAGATION; ANTI-CASCADING STRATEGIES

15:30-16:00 *Session Chairman and Keynote Presenter:* E. Darcy, Battery Technical Discipline Lead NASA-Johnson Space Center Houston, TX, USA.

[LESSONS LEARNED FOR ACHIEVING PASSIVE THERMAL RUNAWAY \(TR\) PROPAGATION RESISTANT \(PPR\) DESIGNS FOR SPACECRAFT BATTERIES](#) (30 min)

Rapporteur: T. Kosmidou (JRC, C.1. Energy Storage Unit)

16:00-16:20 • M. Rohde. Head of the Thermodynamics and Thermophysics group at the Institute of Applied Materials, Karlsruhe Institute of Technology (KIT), Germany. [SAFETY STUDIES ON LI-ION CELLS USING COMBINED CALORIMETRIC AND ELECTROCHEMICAL METHODS](#) (20 min)

16:20-16:40 • C. Middendorf. Automotive and Aerospace Solutions Division 3M Deutschland GmbH. [DESIGN CONCEPTS AND MATERIALS FOR THERMAL PROPAGATION PREVENTION](#) (20 min)

16:40-17:10 • Open discussion (30 min)

19:30 *Workshop dinner offered by JRC at Heeren van Sonoy, Alkmaar*

DAY TWO (9 March 2018)**Meeting room: building 325 – 101 (1st floor)****Session 5. COST AND PERFORMANCE PENALTY OF MITIGATING THERMAL PROPAGATION**

8:30-9:00 *Session Chairman and Keynote Presenter:* W. Prochazka, Product Manager, Global Battery Management Team, AVL LIST GMBH, Austria. **COST AND PERFORMANCE PENALTY OF THERMAL PROPAGATION MITIGATION AND VENTING MEASURES** (30 min)

Rapporteur: T. Kosmidou (JRC, C.1. Energy Storage Unit)

9:00-9:20 • P. Kritzer. Senior Application Manager. E-Mobility. Freudenberg Automotive Sales.
PREVENTING THERMAL PROPAGATION – APPROACHES & EFFORT TO IMPLEMENT THEM IN A BATTERY SYSTEM (20 min)

9:20-9:40 • R. Hettrich. Key Account Manager. CTCadvanced GmbH.
PROPAGATION TESTS ON LITHIUM ION BATTERIES FROM THE PERSPECTIVE OF AN ACCREDITED TEST LAB (20 min)

9:40-10:10 • Open discussion (30 min)

10:10-10:40 *Coffee break (building 325 hall)*

Session 6. IMPACT OF AVOIDING THERMAL PROPAGATION ON THE CURRENT SAFETY TESTING LANDSCAPE

10:40-11:10 *Session Chairman and Keynote Presenter:* D. Doughty, Battery Safety Consulting Inc., Albuquerque, USA. **THE LANDSCAPE OF THERMAL RUNAWAY PROPAGATION TESTING** (30 min)

Rapporteur: F. Di Persio (JRC, C.1. Energy Storage Unit)

11:10-11:30 • T. Timke, Solarwatt.
CURRENT AND FUTURE PROPAGATION TESTS AND THE EMBEDDING IN PRODUCT SAFETY (20 min)

11:30-11:50 • N. Lemmert. Karlsruhe Institute of Technology (KIT), Germany
KIT LI-ION BATTERY RESEARCH – THERMAL PROPAGATION (20 min)

11:50-12:20 • Open discussion (30 min)

12:20-13:20 *Lunch break (building 325 hall)*

13:20-15:30 Open discussion for identifying key points and future steps:

- Summary of each session
- Open discussion

Conclusions and closure of meeting

15:30-16:00 *Coffee break (building 325 hall)*

16:00-16:30 Lab visit (*optional for interested participants*)

Annex 2. List of participants

Last Name	First Name	Affiliation	Origin	Business
Börner	Markus	University of Münster, MEET Battery Research Center	Germany	Research
Chanson	Claude	RECHARGE	France	Industry
Coman	Paul	Independent Researcher	Denmark	Research
Darcy	Eric	NASA-Johnson Space Center, Houston	USA	Research
Dejanovic	Nenad	AVL LIST GMBH	Austria	Industry
Doughty	Daniel	Battery Safety Consulting Inc.	USA	Consulting
Döring	Harry	Zentrum für Sonnenenergie-und Wasserstoff-Forschung Baden-Württemberg (ZSW)	Germany	Testing body
Geppert	Michael	TÜV SÜD Battery Testing GmbH	Germany	Testing body
Gerard	Matthias	CEA Tech	France	Research
Golubkov	Andrej	Virtual Vehicle	Austria	Research
Gutierrez	César	CIDETEC	Spain	Research
Hettrich	Ralf	CTCadvanced GmbH	Germany	Testing body
Keyser	Matthew	National Renewable Energy Laboratory (NREL)	USA	Research
Kolp	Elisabeth	Technical University of Munich (TUM)	Germany	Research
Kritzer	Peter	Freudenberg Sealing Technologies	Germany	Industry
Larsson	Fredrik	RISE Research Institutes of Sweden	Sweden	Research
Lemmertz	Nicolaus	Karlsruhe Institute of Technology (KIT)	Germany	Research

Last Name	First Name	Affiliation	Origin	Business
Middendorf	Claus	Automotive and Aerospace Solutions Division 3M, Deutschland GmbH	Germany	Industry
Orendorff	Christopher	Sandia National Laboratories	USA	Research
Prochazka	Wenzel	AVL LIST GMBH	Austria	Industry
Rohde	Magnus	Karlsruhe Institute of Technology (KIT)	Germany	Research
Scharner	Sebastian	BMW AG	Germany	Industry
Timke	Thomas	Solarwatt GmbH	Germany	Industry
Weydanz	Wolfgang	Robert Bosch GmbH	Germany	Industry

European Commission Participants JRC.C.1, Petten, Netherlands	
Adanouj	Ibtissam
Bielewski	Marek
Brett	Lois
Di Persio	Franco
Kosmidou	Theodora
Kriston	Akos
Lebedeva	Natalia
Napolitano	Emilio
Pfrang	Andreas
Ruiz Ruiz	Vanesa
Steen	Marc

GETTING IN TOUCH WITH THE EU

In person

All over the European Union there are hundreds of Europe Direct information centres. You can find the address of the centre nearest you at: https://europa.eu/european-union/contact_en

On the phone or by email

Europe Direct is a service that answers your questions about the European Union. You can contact this service:

- by freephone: 00 800 6 7 8 9 10 11 (certain operators may charge for these calls),
- at the following standard number: +32 22999696, or
- by electronic mail via: https://europa.eu/european-union/contact_en

FINDING INFORMATION ABOUT THE EU

Online

Information about the European Union in all the official languages of the EU is available on the Europa website at: https://europa.eu/european-union/index_en

EU publications

You can download or order free and priced EU publications from EU Bookshop at: <https://publications.europa.eu/en/publications>. Multiple copies of free publications may be obtained by contacting Europe Direct or your local information centre (see https://europa.eu/european-union/contact_en).



**The European Commission's
science and knowledge service**
Joint Research Centre

JRC Mission

As the science and knowledge service of the European Commission, the Joint Research Centre's mission is to support EU policies with independent evidence throughout the whole policy cycle.



EU Science Hub
ec.europa.eu/jrc



@EU_ScienceHub



EU Science Hub - Joint Research Centre



Joint Research Centre



EU Science Hub



Publications Office

doi:10.2760/096975

ISBN 978-92-79-96399-5