



U.S. Department  
of Transportation

**National Highway  
Traffic Safety  
Administration**



---

DOT HS 812 756

July 2019

# **Ford Safety Performance Of Rechargeable Energy Storage Systems**

## **DISCLAIMER**

This publication is distributed by the U.S. Department of Transportation, National Highway Traffic Safety Administration, in the interest of information exchange. The opinions, findings and conclusions expressed in this publication are those of the authors and not necessarily those of the Department of Transportation or the National Highway Traffic Safety Administration. The United States Government assumes no liability for its contents or use thereof. If trade or manufacturers' names are mentioned, it is only because they are considered essential to the object of the publication and should not be construed as an endorsement. The United States Government does not endorse products or manufacturers.

Suggested APA Format Citation:

Masias, A. (2019, July). *Ford safety performance of rechargeable energy storage systems* (Report No. DOT HS 812 756). Washington, DC: National Highway Traffic Safety Administration.

<b>1. Report No.</b> DOT HS 812 756		<b>2. Government Accession No.</b>		<b>3. Recipient's Catalog No.</b>	
<b>4. Title and Subtitle</b> Ford Safety Performance of Rechargeable Energy Storage Systems				<b>5. Report Date</b> July 2019	
<b>7. Authors</b> Alvaro Masias				<b>6. Performing Organization Code</b>	
<b>9. Performing Organization Name and Address</b> Research and Advanced Engineering Ford Motor Company 2101 Village Road Dearborn, MI 48126				<b>8. Performing Organization Report No.</b>	
<b>12. Sponsoring Agency Name and Address</b> National Highway Traffic Safety Administration 1200 New Jersey Avenue SE Washington, DC 20590				<b>10. Work Unit No. (TRAIS)</b>	
				<b>11. Contract or Grant No.</b> Contract No. DTNH22-11-C-00214	
<b>13. Type of Report and Period Covered</b> Final Report				<b>14. Sponsoring Agency Code</b>	
<b>15. Supplementary Notes</b>					
<b>16. Abstract</b> This study of rechargeable energy storage systems (RESS) in electrified vehicles had the objective of defining lithium ion battery performance based safety-metrics, safety performance test procedures and metrics that can be conducted at the vehicle level, informed by data at the string, module and pack level. The research involved the identification, review and assessment of existing test procedures to determine adequacy and applicability to this research. To define priority failure events in the RESS, a fault tree Analysis (FTA) was conducted that lead to the identification of crush, overcharge and short circuits as principle fault mechanisms, and provided an understanding of the key faults within those failure modes. With the FTA and existing test procedures reviews completed, new test procedures were prepared. Test material consisting of cell strings, module and packs, made from three different cell designs and representative of current Li-ion automotive batteries, were fabricated. Testing sources with the ability to handle high energy battery abuse assessments were identified and, through the course of the research, three were used to perform the tests following the developed procedures. The testing included data acquisition for voltage, current and temperature and was supported with photographic and video files that provided the ability to relate physical events to data points of interest to the researchers. The result is a set of reproducible and repeatable test procedures that indicate the threshold levels that should not be exceeded in a vehicle fault event.					
<b>17. Key Words</b>				<b>18. Distribution Statement</b> Document is available to the public from the National Technical Information Service, <a href="http://www.ntis.gov">www.ntis.gov</a> .	
<b>19. Security Classif. (of this report)</b> Unclassified		<b>20. Security Classif. (of this page)</b> Unclassified		<b>21. No. of Pages</b> 224	<b>22. Price</b>

Form DOT F 1700.7 (8-72)

Reproduction of completed page authorized

## Table of Contents

<b>1.</b>	<b>Executive Overview .....</b>	<b>1</b>
<b>2.</b>	<b>Background .....</b>	<b>1</b>
2.1.	Goal .....	2
2.2.	Objectives:.....	2
<b>3.</b>	<b>Approach .....</b>	<b>2</b>
3.1.	Fault Tree Analysis .....	5
3.2.	Existing Standard Review .....	6
3.3.	Demonstrate Feasibility Testing.....	7
<b>4.</b>	<b>Task Management.....</b>	<b>12</b>
4.1.	Task 1 Planning and Program Management .....	13
4.2.	Task 2 Single Level Failure and Task 3 Multi-level Failure.....	15
<b>5.</b>	<b>Fault Tree .....</b>	<b>16</b>
5.1.	Defined FTA Scope.....	17
5.2.	Identified Fault Branches .....	18
5.3.	Developed FTA Structure .....	18
5.4.	Defined Control Volume Boundary Diagram .....	22
5.5.	Review of the Developed FTA.....	26
<b>6.</b>	<b>Existing Standards Review.....</b>	<b>27</b>
6.1.	Elements addressed .....	28
6.2.	Test Types Identified from FTA .....	30
<b>7.</b>	<b>Overall Procedure Development .....</b>	<b>32</b>
7.1.	Global Test Procedure .....	32
7.2.	Overcharge Procedure .....	35
7.3.	Crush Procedure .....	36
7.4.	Short Circuit Procedure .....	40
<b>8.</b>	<b>Test Material Designs .....</b>	<b>42</b>
8.1.	Test Hierarchy .....	42
8.2.	Test Hardware Objectives .....	42
8.3.	Hardware Selection and Preparation .....	42
8.4.	Type A.....	43

8.5.	Type B.....	45
8.6.	Type C.....	46
<b>9.</b>	<b>Testing.....</b>	<b>47</b>
9.1.	Site Assessment Procedure.....	47
9.2.	Selected Testing Sites.....	50
9.3.	Testing Plan Overview.....	55
9.4.	Testing Summary.....	55
<b>10.</b>	<b>Data Analysis.....</b>	<b>57</b>
10.1.	Test Variables Rubric.....	58
10.2.	Crush Markers.....	62
10.3.	Overcharge Markers.....	64
10.4.	Short Circuit Markers.....	65
10.5.	Crush Analysis.....	66
10.6.	Overcharge Analysis.....	113
10.7.	Short Circuit analysis.....	140
<b>11.</b>	<b>Vehicle Level Procedural Development.....</b>	<b>153</b>
11.1.	Approach.....	153
11.2.	Recommended Procedures.....	153
<b>12.</b>	<b>Conclusion.....</b>	<b>155</b>
<b>Appendix A: Battery Abuse Crush Test Procedure.....</b>		<b>A-1</b>
<b>Appendix B: Battery Abuse Overcharge Test Procedure.....</b>		<b>B-1</b>
<b>Appendix C: Battery Abuse Short Circuit Test Procedure.....</b>		<b>C-1</b>
<b>Appendix D: Lessons Learned.....</b>		<b>D-1</b>

## Table of Figures

Figure 1 Project Organization.....	3
Figure 2 Project Approach.....	4
Figure 3 Project Schedule by Task.....	5
Figure 4 Fault Tree Process.....	6
Figure 5 RESS System Testing Hierarchy.....	8
Figure 6 Program Hardware Quantity History.....	11
Figure 7 FTA Upper Level Events.....	18
Figure 8 Fault Tree Layout.....	19
Figure 9 Thermal Branch Example.....	20
Figure 10 Thermal Branch Example (continued).....	21
Figure 11 Fault Tree Analysis Boundary Diagram.....	22
Figure 12 BMS Boundary Definition Iteration Process.....	23
Figure 13 Basic BMS Functions and Boundaries.....	24
Figure 14 Advanced BMS Functions and Boundaries.....	24
Figure 15 Crush Fixture Example.....	37
Figure 16 Crush Platen.....	37
Figure 17 Platen Rotation Options.....	38
Figure 18 Device Testing Overview.....	42
Figure 19 Type A String Configuration Photos.....	44
Figure 20 Type A String Configurations.....	44
Figure 21 Type B Module.....	45
Figure 22 Type B String (Banded (L) End Plate (R).....	45
Figure 23 Type C String.....	46
Figure 24 Type C Module.....	46
Figure 25 Type C Pack Feature.....	47
Figure 26 Test Sites Considered.....	49
Figure 27 SNL Crush Fixture.....	51
Figure 28 SNL Overcharge Fixtures.....	51
Figure 29 SNL Short Circuit Fixture.....	52
Figure 30 SNL Pack Test Site (Planned).....	52
Figure 31 MGA Research Test Site.....	53
Figure 32 SNL Pack Test Site (Actual).....	54
Figure 33 SwRI Test Site.....	54
Figure 34 Cumulative Tests Performed.....	55
Figure 35 Rubric Voltages versus SOC.....	60
Figure 36 Rubric Marker and Engineering Judgment Marker.....	61
Figure 37 Example of Crush Markers Plot Overcharge Markers.....	63
Figure 38 Example of Overcharge Marker Plot.....	64
Figure 39 Example of Short Circuit Marker Plot.....	65

Figure 40 Force/Displacement Data for Type A String, X-Axis 20-Step (CR006).....	66
Figure 41 X-Axis Crush Analysis.....	67
Figure 42 Y-Axis Crush Analysis.....	68
Figure 43 Z-Axis Crush Analysis.....	69
Figure 44 Crush Analysis Summary.....	70
Figure 45 X-Axis String (EUCAR 5).....	70
Figure 46 X-Axis Continuous String Type A Pre-Test Fixture (CRXCA03).....	71
Figure 47 X-Axis Continuous String Type A Post-Test Fixture (CRXCA03).....	71
Figure 48 X-Axis Continuous String Type A Post-Test Hardware (CRXCA03).....	72
Figure 49 X-Axis Continuous String Type B Pre-Test Fixture (CR015).....	72
Figure 50 X-Axis Continuous String Type B Post-Test Fixture (CR015).....	73
Figure 51 X-Axis Continuous String Type C Pre-Test Fixture (CR042).....	73
Figure 52 X-Axis Continuous String Type C Post-Test Hardware (CR042).....	74
Figure 53 X-Axis Module (EUCAR 5).....	75
Figure 54 X-Axis Continuous Type A Module Pre-Test (CR057).....	75
Figure 55 X-Axis Continuous Type A Module Post-Test (CR057).....	76
Figure 56 X-Axis 20-Step Type A Module Pre-Test Fixture (CR060).....	76
Figure 57 X-Axis 20-Step Type A Module Post-Fixture (CR060).....	77
Figure 58 Y-Axis String (EUCAR 5).....	78
Figure 59 Y- Axis Continuous String Type A Pre-Test Fixture (CR012).....	79
Figure 60 Y-Axis Continuous String Type B Post-Test Fixture (CR012).....	79
Figure 61 Y-Axis Continuous String Type B Pre-Test Fixture (CR021).....	80
Figure 62 Y-Axis Continuous String Type B Post-Test Fixture (CR021).....	80
Figure 63 Y-Axis Continuous String Type C Pre-Test Fixture (CR037).....	81
Figure 64 Y-Axis Continuous String Type C Post-Test Fixture (CR037).....	81
Figure 65 Y-Axis Module (EUCAR 5).....	82
Figure 66 Y-Axis 20-Step Module Type A Pre-Test Fixture (CRY20SAM01).....	83
Figure 67 Y-Axis 20-Step Module Type A Post-Test Fixture (CRY20SAM01).....	83
Figure 68 Y-Axis 20 Step Module Type B Pre-Test Fixture (CRY20SMB01).....	84
Figure 69 Y-Axis 20 Step Module Type B Post-Test Fixture (CRY20SMB01).....	84
Figure 70 Z-Axis String (EUCAR 5).....	85
Figure 71 Z-Axis Continuous String Type A Pre-Test Fixture (CR065).....	86
Figure 72 Z-Axis Continuous String Type A Post-Test Fixture (CR065).....	86
Figure 73 Z-Axis Continuous String Type B Pre-Test Fixture (CR027).....	87
Figure 74 Z-Axis Continuous String Type B Post-Test Fixture (CR027).....	87
Figure 75 Z-Axis Continuous String Type C Pre-Test Fixture (CR033).....	88
Figure 76 Z-Axis Continuous String Type C Post-Test Fixture (CR033).....	88
Figure 77 Z-Axis Module (EUCAR 5).....	89
Figure 78 Z-Axis Continuous Module Type A Pre-Test Fixture (CR062).....	90
Figure 79 Z-Axis Continuous Module Type A Post-Test Fixture (CR062).....	90
Figure 80 Z-Axis Continuous Module Type B Pre-Test Fixture (CR056).....	91

Figure 81 Z-Axis Continuous Module Type B Post-Test Fixture (CR056)	91
Figure 82 Type A X-Axis (EUCAR 5)	92
Figure 83 X-Axis 20-Step Pack Type A Pre-Test Fixture (5)	93
Figure 84 X-Axis 20-Step Pack Type A Post-Test Fixture (5)	93
Figure 85 Type A Y-Axis (EUCAR 5)	94
Figure 86 Y-Axis 20-Step Pack Type A Pre-Test Fixture (6)	95
Figure 87 Y-Axis 20-Step Pack Type A Post-Test Fixture (6)	95
Figure 88 Type A Z-Axis (EUCAR 5)	96
Figure 89 Z-Axis 20-Step Pack Type A Pre-Test Fixture (3)	97
Figure 90 Z-Axis 20-Step Pack Type A Post-Test Fixture (3)	97
Figure 91 Type B X-Axis (EUCAR 5)	98
Figure 92 X-Axis 3-Step String Type B Pre-Test Fixture (CR017)	99
Figure 93 X-Axis 3-Step String Type B Post-Test Hardware (CR017)	99
Figure 94 Type B Y-Axis (EUCAR 5)	100
Figure 95 Y-Axis 20-Step String Type B Pre-Test Fixture (CRY20SB01)	101
Figure 96 Y-Axis 20-Step String Type B Post-Test Fixture (CRY20SB01)	101
Figure 97 Type B Z-Axis (EUCAR 5)	102
Figure 98 Z-Axis 20-Step String Type B Pre-Test Fixture (CR032)	103
Figure 99 Z-Axis 20-Step String Type B Post-Test Fixture (CR032)	103
Figure 100 Type C X-Axis (EUCAR 5)	104
Figure 101 X-Axis 20-Step String Type C Pre-Test Fixture (CR044)	105
Figure 102 X-Axis 20-Step String Type C Post-Test Fixture (CR044)	105
Figure 103 Type C Y-Axis (EUCAR 5)	106
Figure 104 Y-Axis 20-Step String Type C Pre-Test Fixture (CR049)	107
Figure 105 Y-Axis 20-Step String Type C Post-Test Fixture (CR049)	107
Figure 106 Type C Z-Axis (EUCAR 5)	108
Figure 107 Z-Axis 20-Step String Type C Pre-Test Fixture (CR041)	109
Figure 108 Z-Axis 20-Step String Type C Post-Test Fixture (CR041)	109
Figure 109 Pack (EUCAR 5)	110
Figure 110 Y-Axis 20-Step Pack Type C Pre-Test Fixture (5)	111
Figure 111 Y-Axis 20-Step Pack Type C Post-Test Fixture (5)	111
Figure 112 Z-Axis 20-Step Pack Type C Pre-Test Fixture (6)	112
Figure 113 Z-Axis 20-Step Pack Type C Post-Test Fixture (6)	112
Figure 114 Overcharge Response of Type A String, Start/Stop 150A (OCPSA01)	113
Figure 115 Overcharge Analysis Data	114
Figure 116 Overcharge Analysis Summary	114
Figure 117 Continuous String (EUCAR 5)	115
Figure 118 Continuous 32A String Type A Pre-Test Fixture (OCICA02)	116
Figure 119 Continuous 32A String Type A Post-Test Fixture (OCICA02)	116
Figure 120 Continuous 32A String Type B Pre-Test Fixture (OCICB01)	117
Figure 121 Continuous 32A String Type B Post-Test Fixture (OCICB01)	117



Figure 122 Continuous 72A String Type C Pre-Test Fixture (OC048).....	118
Figure 123 Continuous 72A String Type C Post-Test Fixture (OC048) .....	118
Figure 124 Continuous Module (EUCAR 5).....	119
Figure 125 Continuous 77A Module Type A Pre-Test Fixture (OC024).....	120
Figure 126 Continuous 77A Module Type A Post-Test Fixture (OC24) .....	120
Figure 127 Continuous 75A Module Type B Pre-Test Fixture (OC041) .....	121
Figure 128 Continuous 75A Module Type B Post-Test Fixture (OC041).....	121
Figure 129 Start/Stop String (EUCAR 5).....	122
Figure 130 Start/Stop 60A String Type A Pre-Test Fixture (OCISA01).....	123
Figure 131 Start/Stop 60A String Type A Post-Test Fixture (OCISA01).....	123
Figure 132 Start/Stop 60A String Type B Pre-Test Fixture (OC009) .....	124
Figure 133 Start/Stop 60A String Type B Post-Test Fixture (OC009).....	124
Figure 134 Start/Stop Module (EUCAR 5) .....	125
Figure 135 Start/Stop 61A Module Type A Pre-Test Fixture (OC027) .....	126
Figure 136 Start/Stop 61A Module Type A Post-Test Fixture (OC027).....	126
Figure 137 Type A Continuous (EUCAR 5) .....	127
Figure 138 Continuous 155A String Type A Pre-Test Fixture (OCPCA02).....	128
Figure 139 Continuous 155A String Type A Post-Test Fixture (OCPCA02) .....	128
Figure 140 Continuous 153A Module Type A Pre-Test Fixture (OC025).....	129
Figure 141 Continuous 153A Module Type A Post-Test Fixture (OC025) .....	129
Figure 142 Type A Start/Stop (EUCAR 5).....	130
Figure 143 Start/Stop 155A String Type A Pre-Test Fixture (OCPSA01).....	131
Figure 144 Start/Stop 155A String Type A Post-Test Fixture (OCPSA01) .....	131
Figure 145 Start/stop 60A Module Type A Pre-Test Fixture (OC028).....	132
Figure 146 Start/stop 60A Module Type A Post-Test Fixture (OC028) .....	132
Figure 147 Type B Continuous (EUCAR 5).....	133
Figure 148 Continuous 149A String Type B Pre-Test Fixture (OC035).....	134
Figure 149 Continuous 149A String Type B Post-Test Fixture (OC035) .....	134
Figure 150 Continuous 149A Module Type B Pre-Test Fixture (OC044).....	135
Figure 151 Continuous 149A Module Type B Post-Test Fixture (OC044).....	135
Figure 152 Type B Start/Stop (EUCAR 5).....	136
Figure 153 Start/Stop 77A String Type B Pre-Test Fixture (OC038) .....	137
Figure 154 Start/Stop 77A String Type B Post-Test Fixture (OC038).....	137
Figure 155 Type C Continuous (EUCAR 5).....	138
Figure 156 Continuous 149A String Type C Pre-Test Fixture (OC049).....	139
Figure 157 Continuous 149A String Type C Post-Test Fixture (OC049) .....	139
Figure 158 Type C Start/Stop (EUCAR 5) .....	140
Figure 159 Electrical Response of Type A String Medium (SC005).....	141
Figure 160 Short Circuit Analysis Data.....	142
Figure 161 Short Circuit Analysis Summary.....	142
Figure 162 Short-Circuit Response, String.....	143

Figure 163 Hard String Type A Pre-Test Fixture (SSHA01) .....	144
Figure 164 Hard String Type A Post-Test Fixture (SSHA01).....	144
Figure 165 Hard String Type B Pre-Test Fixture (SSHB01).....	145
Figure 166 Hard String Type B Post-Test Fixture (SSHB01) .....	145
Figure 167 Short Circuit Response, Module.....	146
Figure 168 Hard Module Type A Pre-Test Fixture (SC014).....	147
Figure 169 Hard Module Type A Post-Test Fixture (SC014) .....	147
Figure 170 Short Circuit Response, Type A.....	148
Figure 171 Medium String Type A Pre-Test Fixture (SC004).....	149
Figure 172 Medium String Type A Post-Test Fixture (SC004) .....	149
Figure 173 Medium Module Type A Pre-Test Fixture (SC017) .....	150
Figure 174 Medium Module Type A Post-Test Fixture (SC017).....	150
Figure 175 Short Circuit Response, Type B.....	151
Figure 176 Hard Module Type B Pre-Test Fixture (SC016) .....	152
Figure 177 Hard Module Type B Post-Test Fixture (SC016).....	152
Figure 178 Summary of Project Approach and Method.....	155

## **1. Executive Overview**

This study of rechargeable energy storage systems (RESS) in electrified vehicles was undertaken under NHTSA Contract Award DTNH22-11-C-00214 with the objective of defining lithium ion battery performance-based safety metrics, safety performance test procedures, and metrics that can be conducted at the vehicle level, informed by data at the string, module, and pack level. The research involved the identification, review, and assessment of existing test procedures to determine adequacy and applicability to this research. To define priority failure events in the RESS, a fault tree analysis (FTA) was conducted that led to the identification of crush, overcharge, and short circuits as principle fault mechanisms, and provided an understanding of the key faults in those failure modes. With the FTA and existing test procedures reviews completed, new test procedures were prepared. Test material consisting of cell strings, module, and packs, made from three different cell designs and representative of current Li-ion automotive batteries, were fabricated. Testing sources with the ability to handle high-energy battery abuse assessments were identified and, through the course of the research, three were used to perform the tests following the developed procedures. The testing included data acquisition for voltage, current and temperature and was supported with photographic and video files that provided the ability to relate physical events to data points of interest to the researchers. The result is a set of reproducible and repeatable test procedures that indicate the threshold levels that should not be exceeded in a vehicle fault event.

## **2. Background**

Ford Motor Company's Research and Advanced Engineering undertook a project in response to a solicitation (DTNH22-11-R-00438) from NHTSA to perform research in developing safety test methods and performance based safety-metrics for lithium-ion-battery-based RESS. The project required identifying and documenting appropriate test conditions, boundary limitations, and performance criteria that could be applied to vehicle level testing when possible, component level when necessary, or both. The RESS configurations were to be inclusive of and limited to presently identified lithium-ion-battery-based RESS and foreseeable advanced electrical energy storage devices or battery technologies for use in HEV, PHEV, or EV applications on passenger cars, light trucks, or multipurpose vehicles independent of chemistry composition, cell format, or construction, or cell arrangement. The solicitation asked that the project develop and demonstrate meaningful, comparable, and quantitative evaluations linking test procedures to failure modes associated with component failure, control system failure, and/or potential abuse conditions using test procedure development, automotive RESS design, and RESS equipped vehicle safety performance development experience. The work was undertaken under NHTSA Contract Award DTNH22-11-C-00214.

## **2.1. Goal**

The goal of the project was to provide NHTSA with well defined, comprehensively documented, and repeatable vehicle or component level safety performance test procedures to evaluate lithium ion battery based RESS performance with appropriate boundary conditions in the case of an abuse fault event.

## **2.2. Objectives:**

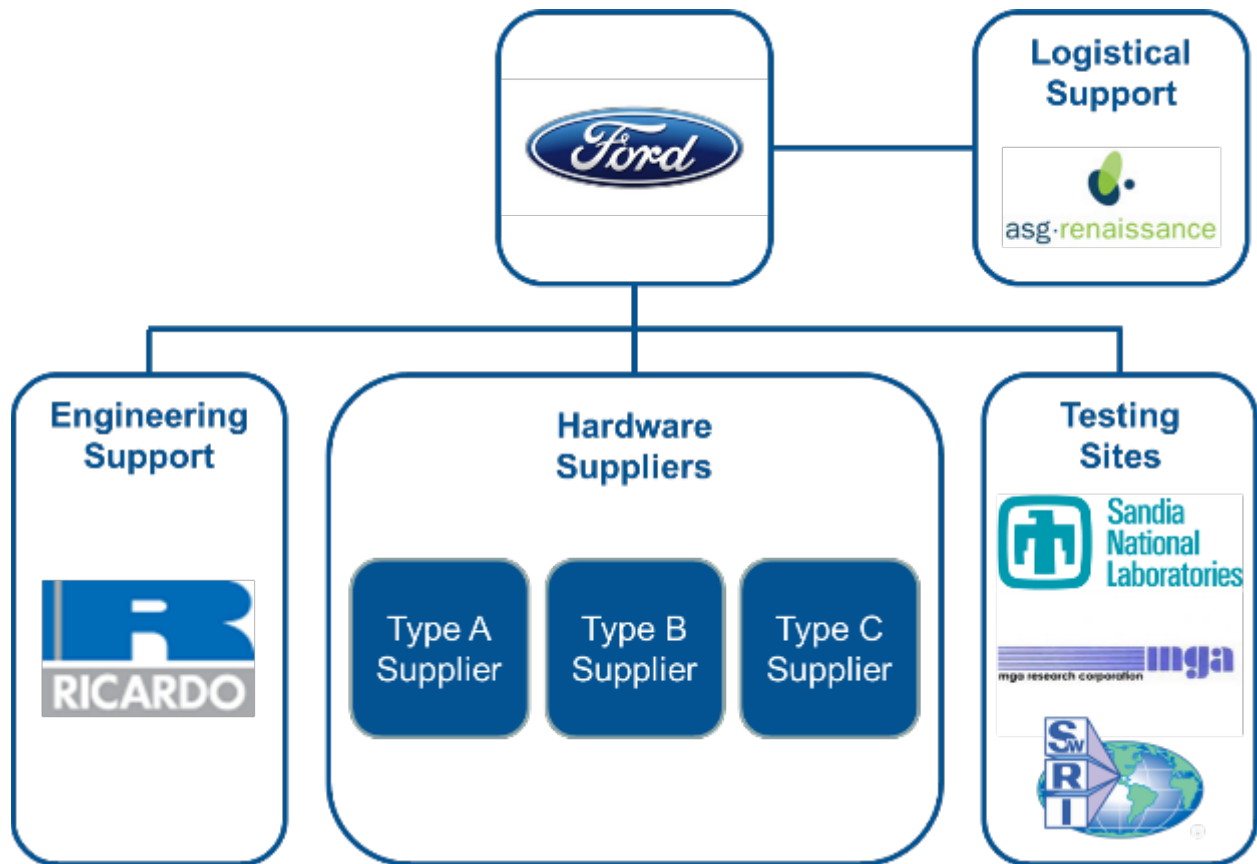
The objective of this project is to define RESS safety performance test procedures and metrics that can be conducted at the vehicle level, and informed by data at the cell, module and pack level. In support of this objective, the project:

- Defined RESS safety performance tests that can be conducted at the vehicle level, but which draw judiciously upon information acquired at the cell string, module and pack level.
- Evaluated cell level failure modes, and possible propagation of cell failure modes within the RESS in light of anticipated fault mechanisms during operating conditions.

## **3. Approach**

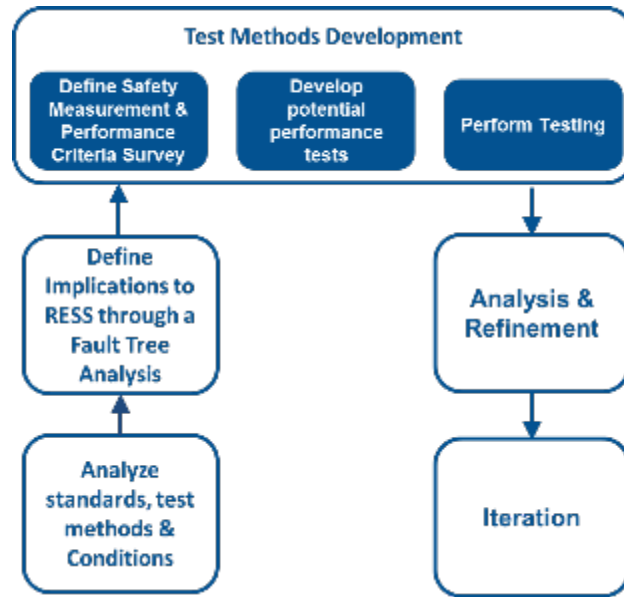
This project focused on identifying and documenting appropriate test conditions, boundary limitations, and performance criteria that can be applied to vehicle level testing when possible, and most directly at the component level.

To accomplish this goal, Ford organized a group of organizations for engineering and logistical support, as hardware suppliers and test sites (see Figure 1). Ford envisioned that physical testing would be required to validate boundary limitations and performance criteria. As a result, Ford used the engineering experience of Ricardo, an international engineering services company with experience in RESS systems and electric vehicles, to provide an additional assessment of the various aspects of the project and to bring a different perspective from that of the Ford team. ASG Renaissance, a business services firm, provided logistical staff support to the project team. Additionally, three different hardware suppliers (identified as Type A, Type B and Type C) were engaged to provide a diverse set of test hardware for this project. Likewise, three different test sites, Sandia National Labs, MGA Research, and Southwest Research Institute, were used to perform the developed test procedures.



**Figure 1 Project Organization**

An overview of the technical approach is shown graphically in Figure 2. To begin, the project team conducted concurrent reviews and assessments to both develop a document that summarized and critiqued existing RESS test standards and methods, and also to complete a fault tree analysis (FTA). The analysis of existing industry test methods considered all potentially relevant existing RESS safety standards and defined which failure modes are adequately addressed by the existing methods. All reasonable vehicle operational states and conditions were evaluated and factored into the overall assessment.



**Figure 2 Project Approach**

Based on the extensive combined experience of Ford and Ricardo, the team developed a rigorous FTA to define the appropriate testing and hardware level (cell string, module, or pack) requirements. Boundary conditions and limitations were established based on the quantifiable impact to the RESS hardware at the vehicle level for all operational states and conditions. From these, existing standards and test methods were selected and enhanced where appropriate, or new test methods and procedures were developed in order to adequately address real world RESS safety performance.

Following the development of these project specific testing procedures, feasibility testing was conducted to determine the most informative component testing levels (i.e., cell, module or pack) and to confirm which were most beneficial. Data produced during the test runs was analyzed to identify any meaningful markers that could provide early predictors of high severity RESS events. As testing proceeded and the data provided new insights, the fault tree and Standards Review tasks were revisited to enhance future application.

The overall schedule followed through the program in response to the original NHTSA task breakdown is shown in Figure 3. Task 2 is represented by the section of the schedule labeled Active. The task 2 activity called for the consideration of a single fault of electrical, mechanical or thermal origin. As a result of this NHTSA defined background, the project viewed Task 2 as pertaining to active safety because a functioning battery control system would be able to respond to a fault. Task 3 was defined by NHTSA as a repeat of Task 2 with a second fault affecting all battery control systems and making them unable to respond to the original fault. The project team considered Task 3 as being representative of passive safety given the lack of a functioning control system and the schedule for this task is also shown in Figure 3.

		Year 1				Year 2				Year 3			
		Q1	Q2	Q3	Q4	Q1	Q2	Q3	Q4	Q1	Q2	Q3	Q4
Active	Work Plan												
	Develop												
	Perform												
	Document												
Passive	Work Plan												
	Develop												
	Perform												
	Document												

Figure 3 Project Schedule by Task

Finally, from all of the work described, a set of conclusions and recommendations were prepared to assist NHTSA in the application of this research to component and vehicle level tests. A summary of each element of the research, the FTA, Standards Review, Testing and Data Analysis, are presented in the following and discussed in detail in sections 4 to 9 of the report.

### 3.1. Fault Tree Analysis

For this project, the fundamental tool for defining events that are critical to the effective assessment of a vehicle RESS is the FTA. While there are many tools available that serve a similar purpose, the FTA was selected as the most appropriate analytical tool for this research project because it applies logic that is independent of any specific system design. It is based on a deductive (i.e., top down) process that explores all of the potential events leading up to a critical or principle (top level) event by identifying the varied combinations of failures of hardware, control or human interaction that would cause the undesired events. It also permits assessments that are event path dependent (multiple fault scenarios) providing a robust understanding of interactions of system elements.

The deductive analysis begins with a stated outcome, then attempts to determine the specific causes of the outcome using a constructed logic diagram. This stepwise resolution of events into immediate causal events is extended until basic causes (primary causes) are identified.

Modeled around the structure of the original NHTSA solicitation, tasks for the FTA were initially planned to be spread out amongst two phases. The first phase was to assess events related

to failure of a single element in the RESS. This phase was described as pertaining to active safety, whereby the vehicle control system would be able to actively address any detected fault. The second phase was to involve a failure of the RESS control system along with a secondary failure, representing passive safety. The FTA process early on identified the importance of defining the RESS control system or battery management system (BMS) functionality. A lack of a commonly accepted industry definition of the functions of the BMS caused the investigation to take place in a single, but more encompassing process, as graphically depicted in Figure 4.

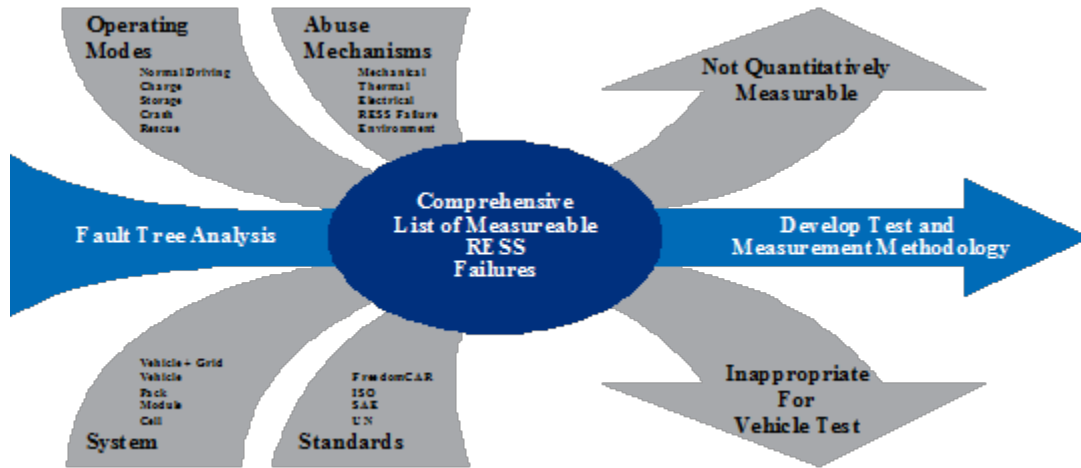


Figure 4 Fault Tree Process

The resultant fault tree is a logical diagram consisting of branches that are developed from the “top down” deductive process, constructed to show the logical relationships of an event to underlying causes. Details of this analysis are presented in Section 4 of this report.

### 3.2. Existing Standard Review

In the original project proposal, Ford assumed that in the many existing testing methods for RESS that could support this research project would already be documented. To confirm this assumption, a table of performance tests described by SAE, UN, ISO, and Freedom Car was prepared. The original table from the project proposal is shown in Table 1. As the project continued and new industry standards were drafted or released, additions to the table were made.



	Test Methods	NHTSA Solicitation	Freedom Car	SAE J2929	SAE J2464	UN 38.3	ISO 12405-1	QC-T 743-2006	ISO 12405-3	ECE R100
Mechanical	Mechanical Integrity	8, 12, 14	3.1	4.6	4.3.6			6.2.12.6 6.3.8.5	8.2	8D
	Penetration	8, 14	3.2		4.3.3			6.2.12.7 6.3.8.6		
	Immersion	3	3.4	4.4	4.3.5				8.3	
	Roll-Over		3.5		4.3.4					
	Drop	10	3.3	4.3	4.3.2	T6		6.2.12.4	6.2	
	Mechanical Shock	11	3.6	4.5	4.3.1	T4	8.4		6.2	8C
	Vibration	1		4.2		T3	8.2	6.2.12.1 6.3.8.1	6.1	8A
Thermal	Fire Exposure	7	4.2	4.7	4.4.1				8.4	8E
	High Temperature Storage		4.3					6.2.12.5 6.3.8.4		
	Cycle w/o Thermal Control	4, 8, 14	4.4	4.11	4.4.3				10.3	8I
	Thermal Shock	9	4.5	4.2.3	4.4.4	T2	8.3		7.1	8B
	Humidity Exposure	2		4.2.4			8.1		7.2	
		Passive Propagation	15,16			4.4.5				
Electrical	Overcharge		5.1	4.9	4.5.2	T7	9.3	6.2.12.2 6.3.8.2	10.1	8G
	Short Circuit	5	5.2	4.8	4.5.1	T5	9.2	6.2.12.3 6.3.8.3	9.1	8F
	Overdischarge	6	5.3	4.10	4.5.3	T8	9.4	6.2.12.1 6.3.8.1	10.2	8H
	High Voltage Exposure			4.13						
	Partial Short Circuit		5.4							
		Separator Shutdown				4.5.4				

Table 1 RESS System Testing Standards

The approach to conducting this review and extracting beneficial elements included an assessment by the team concerning applicability, adaptability and in some cases suggested improvements in the procedures. The outcome of the review would be summarized for reporting in the project. This detail is discussed in Section 5 of this report.

### 3.3. Demonstrate Feasibility Testing

The next step in the project approach was to demonstrate the feasibility of the planned test procedures and performance metrics using actual experimental testing. To accomplish this testing various lithium ion battery hardware were used to experimentally support the development of new test methods. A large range of hardware in terms of size (weight, volume, energy content) and construction (manufacturer, chemistry, and packaging) were selected to ensure the broad applicability of the developed test methods.

### 3.3.1. Develop Feasibility Testing Procedures:

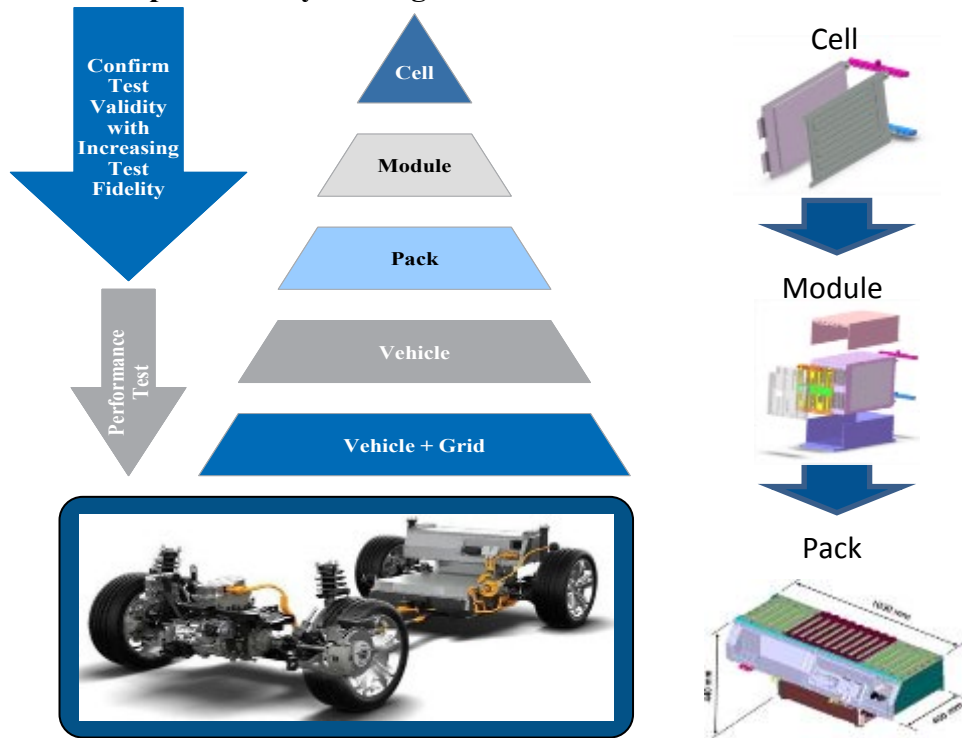


Figure 5 RESS System Testing Hierarchy

An outline of the basis and background for potential scalability of observations at the cell, module and pack levels was developed. This was based on hardware size and the potential generic applicability of observations for multiple geometries, mounting locations and configurations. Through this exercise, gaps in the existing standards as they apply to the vehicle level were discovered and explored. New feasibility testing possibilities were to be proposed as an output from this effort.

Figure 5 graphically depicts the planned testing approach. By first studying the reactions of the cells or short strings of cells, a basis of understanding the smallest element of the systems would be gained. Cell strings were assembled into modules, the internal elements of vehicle battery packs, and tested in procedures similar to the cell strings. Finally, battery packs, built up from modules, were tested following similar procedures. Learning about the RESS system performance in both controlled and uncontrolled events was the intent of this approach.

### 3.3.2. Define Program Testing Scope

The original program was built on the assumptions that overcharge and crush events would likely be the focus of efforts to be addressed in this project. It was assumed in planning that hardware in the forms of strings, modules and packs could be tested to explore responses to abuse events. In that plan, a total of 54 tests using one hardware type were assumed and budgeted.

It was also planned to use the FTA and the work to develop and document tests, methods, and metrics to enhance the planned assessments to ensure that all relevant events were considered.

That work included a focused design of experiment (DOE) activity that, in combination with the FTA, led to an understanding that the value of the project output would be significantly enhanced with an expansion of the test program. Specifically, the team concluded that:

- 1) An additional event assessment, short circuit, should be included in the test program
- 2) Battery design variations should be considered to more realistically develop broadly applicable vehicle level assessments.

Revisions to the plan were designed to increase the kinds and numbers of tests to be performed. This revised plan enhanced the feasibility demonstration with the inclusion of more individual tests for the original hardware type (increased from 54 to 106 and now labeled Type A), and also testing of two additional battery designs (adding two additional battery formats labelled Type B and C spread amongst 106 tests) for a total of 212 tests. This nearly four times increase of test units was accomplished on a cost neutral basis to NHTSA by following internal budget reallocations. The following, Table 2 First Test Program Revision, summarizes the change:

Hardware Type		Initial	Revised
Type A	String	24	60
	Module	24	40
	Pack	6	6
Type B	String	-	30
	Module	-	20
	Pack	-	-
Type C	String	-	30
	Module	-	20
	Pack	-	6
<b>Total</b>		54	212

**Table 2 First Test Program Revision**

As the project developed, it became clear that the program would benefit from side by side testing performed at an additional test site. By performing the same test procedure at multiple sites it would be possible to develop a procedure that was robust to the capabilities of multiple testing locations and sources. This expansion of the testing program would add the potential for 60 more tests of string and module hardware of two design iterations at an alternate testing source. The final test program is contained in Table 3 details 245 tests.

Test	Type	String	Module	Pack	Totals
<b>Crush</b>	A	52	22	6	80
	B	24	10	0	34
	C	18	0	6	24
	Total	94	32	12	138
<b>Over-charge</b>	A	32	15	0	47
	B	12	10	0	22
	C	9	0	0	9
	Total	53	25	0	78
<b>Short Circuit</b>	A	15	6	0	21
	B	4	1	0	5
	C	3	0	0	3
	Total	22	7	0	29
<b>Totals</b>	A	99	43	6	148
	B	40	21	0	61
	C	30	0	6	36
	Total	169	64	12	245

**Table 3 Complete Test Program Plan**

The history of the two project hardware quantity revisions (including timing and individual hardware levels) is shown in Figure 6.

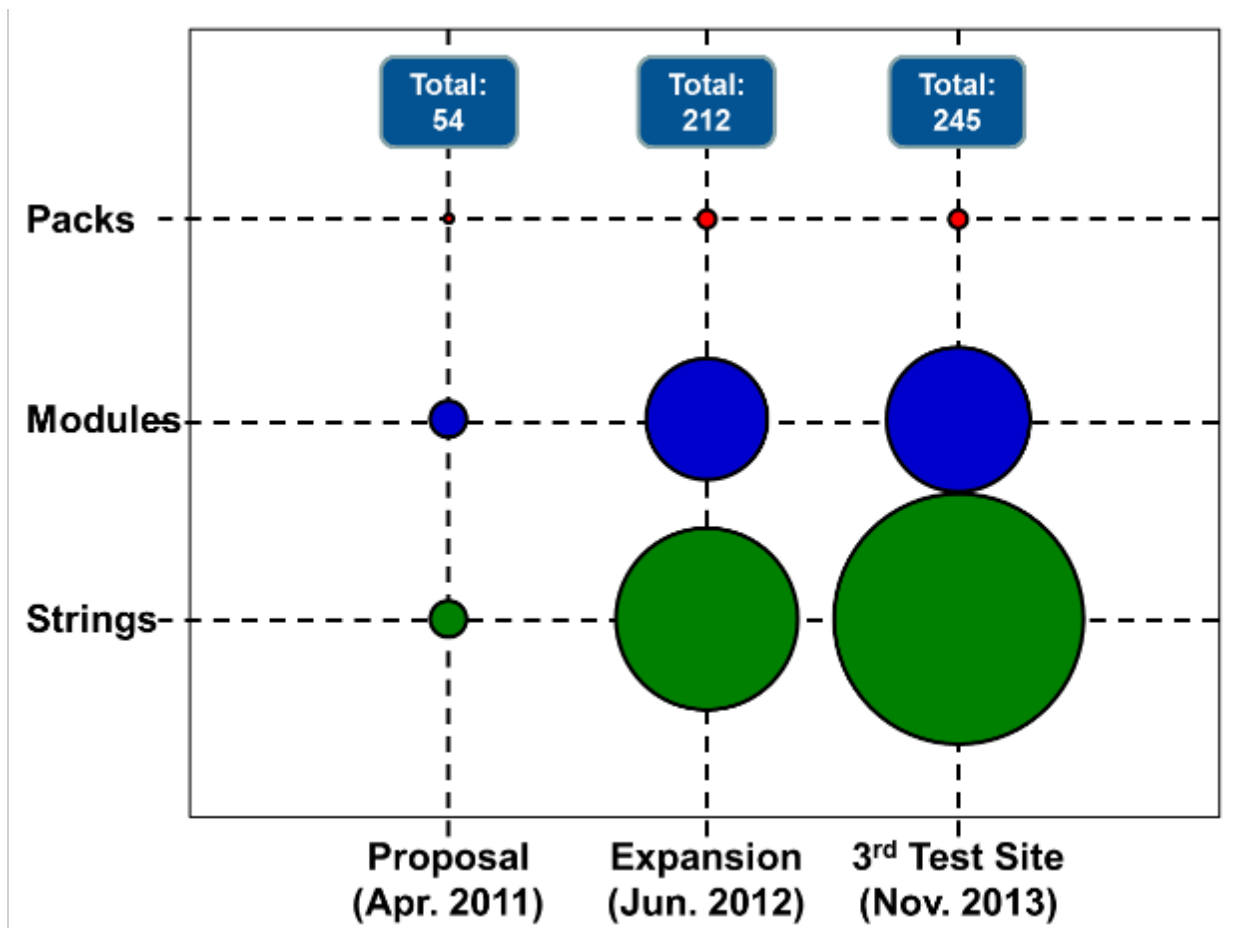


Figure 6 Program Hardware Quantity History

### 3.3.3. Perform Feasibility Testing

Testing was scaled from cells to modules and to a complete battery system, as appropriate. For each of the three test types, overcharge, crush and short-circuit, the relevant factors developed in the design of experiments was different

In the case of overcharge, the normal and maximum charge rates and durations were assessed. Overcharge testing was conducted at all potential on-plug charge current rates and appropriate compliance potentials. All overcharge testing was performed without the benefit of any BMS control or interference at the request of the initial NHTSA solicitation passive safety task.

For crash analysis, the risk of battery cell puncture and crush was considered. Penetration or crush of some portion of the RESS may be acceptable, and one of the goals of this testing was to determine if performance safety metrics could be developed around this factor. For crush testing it was determined to include testing along all three possible axes and to perform the crush motion in 1, 3 and 20 stage events.

During short-circuit testing a range of relative resistance values were assessed. Each battery unit has a specific internal resistance value that affects how it will react to an external short-circuit.

By tuning the resistance of the applied short to that of the device under test it is possible to explore a range of delivered currents and hardware responses.

Over the performance period of the project, several testing sources were employed to perform feasibility tests, and the kinds and numbers of tests performed were expanded.

#### **3.3.4. Data Analysis**

An analytical approach was developed based on the quality, uniformity and comparability of the data extracted from the testing to demonstrate the feasibility of the suggested tests. Work was planned to identify those test outputs and combinations of outputs that provide the most useful understanding of the performance of the RESS system in an abuse event. A focus was maintained on the identification of test variable states that might be used as predictors of critical failures. Additionally, correlations amongst the various test hardware and test sites were made for each test in order to determine the high level performance safety metrics and boundary conditions.

## **4. Task Management**

This project was originally structured to address three specific tasks defined in the original NHTSA research request as follows.

**Task 1** Planning and Program Management

**Task 2** Single Level RESS Failure

**Task 3** Multiple Level RESS Failure

The following summarizes the progress, by task, as the project unfolded.

## **4.1. Task 1 Planning and Program Management**

### **Task 1 Year 1**

The first half of year one focused on planning activities towards implementing the proposals research approach, the assembly of the project team and establishing program management tools. The key element of the ongoing program management activity was the use of weekly team meetings that were generally conducted face-to-face in the early stages of the program. An activity tracking and planning matrix was used in every meeting to clearly identify work tasks to be completed with target dates and assigned responsibilities.

All required reports to NHTSA personnel were rigorously managed so that all such reports or required monthly reviews were conducted on time and in accordance with the requirements of the COTR.

Quarterly project activity reports throughout the year contained comprehensive visual descriptions of the task status, deliverables and financial status. Input from previous monthly discussion meetings was combined with updated inputs from team members to provide the complete overview. Financial updates were also included in all submitted reports.

In the second quarter, updates on activities related to the FTA, test method specifications and the design of experiments were made. In addition, a first draft of the battery Management System diagram that the team was developing to guide work in Task 3, multi-level fault events, was presented.

The third quarter activity provided updates to the overall project budget that showed a program spend rate providing the possibility of testing additional hardware items beyond those originally proposed. A cost analysis of the proposed hardware and candidate alternate hardware was presented to NHTSA. Adding significant additional hardware was deemed to be possible on a cost neutral basis for the project and to be explored further.

In the fourth quarter, as requested in the original NHTSA program solicitation, updated work plans were provided. These updates included two principle elements: an active (Task 2) plan, which was completed on October 28, 2011, and a passive (Task 3) plan that was submitted on June 29, 2012. Finally, an annual report presentation, summarizing the work done from Oct. 1, 2011, to Sep. 30, 2012, was made to NHTSA personnel in Washington DC on December 12, 2012.

## **Task 1 Year 2**

During the program's fifth quarter, the team reported efforts made to respond to NHTSA feedback regarding new test hardware. Alternative hardware vendors had been engaged leading to the Type B and C hardware described in other sections of this report. Additionally, Ford reported a revised, cost-neutral budget redistribution that would support the increased hardware and testing costs for the new hardware.

The sixth quarter work focused on detailed preparation of the Type B and C alternative designs for testing hardware, and providing the foundation of planning for possible alternative testing sites in recognition of ongoing facilities issues at SNL. Data analysis activities were summarized and examples of data presentations were provided to NHTSA.

The seventh quarter work focused on the preparation of testing hardware, the analytical approaches to be used in data manipulation, and updated testing plans. A second testing source, MGA (Akron, NY), was added to the program to perform string and module testing when it became clear SNL would not be able to restart testing promptly.

The second year annual summary of work done was given to a NHTSA review team in Washington DC on November 4, 2013.

## **Task 1 Year 3**

Ford continued to employ the weekly project team meeting as the key element of the ongoing program management activity. Separate weekly or bi-weekly teleconferences were held with each of the testing sites. An activity tracking and planning matrix was used in every meeting to clearly identify work tasks to be completed with target dates and assigned responsibilities. Regular monthly discussions continued with the COTR to ensure coordination of work to meet NHTSA's objectives.

In quarter nine the team continued a coordinated effort to meet the objectives of this project and in an effort to maximize the meaningful output of the testing phase, Ford, with NHTSA concurrence, added a third testing source, Southwest Research Institute (SwRI). The defined role of each test site as the program moved toward completion is shown in Table 4.



Test Site	Testing Role
Sandia National Lab (SNL)	Packs Initially (Strings/Modules/Packs)
MGA	Strings and Modules
Southwest Research Institute	Strings and Modules

**Table 4 Test Hardware Descriptions**

During the tenth quarter, all final test hardware builds were completed and final deliveries made to the testing sites. Planned string and module testing continued at MGA and SwRI, and all 12 planned pack tests were completed at SNL. Throughout the testing phase, Ford personnel maintained communication both remotely and through visits, at each test site.

During the eleventh quarter, all testing was completed and data preparation continued. Ford maintained a steady team approach to mating collected voltage, current and temperature data with both video records of the tests and photo evidence of pre- and post-test sample appearance. In advance of a planned GTR meeting, a NHTSA requested program update was prepared and presented by Ford in a video conference on April 14, 2014, providing a detailed discussion of the program activity along with commentary on the data received to date.

#### **4.2. Task 2 Single Level Failure and Task 3 Multi-level Failure**

As originally conceived and planned, two program tasks were defined to encompass a comprehensive understanding of both fundamental (single-level fault or Active safety) RESS events and complex (multi-level fault or passive safety) events.

The work plans submitted to NHTSA and used to manage the work of the project described the activity in Task 2 to contain the following activities:

- FTA
- Measurable RESS Failures
- Sub Task 2A: Develop Test Methods
- Sub Task 2B: Demonstrate Feasibility

Throughout the first year of the project, work was done in each of these planned areas. The work on the FTA is detailed in section 5 of this report. This work led to the identification of measurable RESS failures. This activity was predominantly completed in year one of the project but the developed assessments were held as living documents and were updated when new considerations or learning dictated. All of the work for development of the test methods resulted from the FTA process but drew upon the planned, detailed review of the existing industry testing procedures. This approach allowed for the use of already recognized procedures where they seemed applicable or potentially modifiable to obtain consistent, meaningful, comparative results.

In June of the first year, Ford provided a work plan for Task 3, Multi-level failures where one fault is contained within the BMS, which built upon the work in Task 2. That plan consisted of:

- Sub Task 3A: Identify and Document Test Methods
- Sub Task 3B: Demonstrate Feasibility
  - 1) Task 3B.1 Perform Testing
  - 2) Task 3B.2 Analysis
  - 3) Task 3B.3 Perform Testing
  - 4) Task 3B.4 Analysis and Reporting
  - 5) Task 3B.5 Final Analysis and Reporting

This work envisioned the identification of meaningful faults in the RESS system that would combine to provide both a basis for preparing new testing procedures as well as planning of feasibility testing.

As analysis and discussion continued within the team through the balance of year one and into the second year, the team initially worked on Task 2 and 3 as separate items. As refinement of the FTA progressed it became clear that distinction between Task 2, Single Level Failures and Task 3 Multi-Level Failures directly tied into the structuring of the test plan. To help clarify this relationship, a definition of the basic functions of the BMS would be useful. To address this issue, the team began work on establishing a definition of BMS functionality for this project. This work is documented in Section 5.4 of this report and helped shaped future test plans, in particular the overcharge test.

Ultimately, the team formulated a testing approach that builds from cell strings to modules and finally to packs in multiple rounds of testing. This approach provided the logic to depart from the planned Task 2/Task 3 structure and to combine all of the procedural development and feasibility testing into single program effort. The change in program logic was presented to NHTSA, discussed and approved by NHTSA in the fourth quarter of the program.

Work on the combined Task 2 and 3 continued throughout the balance of the program and regular reports of progress and challenges were made and discussed with NHTSA personnel.

## **5. Fault Tree**

Amongst the many possible tools, the FTA was selected as the most appropriate analytical tool for this research project for identifying events of most importance to this study because it applies logic that is independent any specific system design. The deductive analysis begins with a stated outcome, then attempts to determine the specific causes of the outcome using a constructed logic diagram.

### 5.1. Defined FTA Scope

In order to sharpen the focus of the FTA a scope and general constraints were created. This allows for the avoidance of non-productive, wide-ranging event types and causes, which may detract from the analytical process. Based on the original NHTSA solicitation and the Ford proposal, the following scope for the FTA was established to guide its development (Table 5).

<b>Fault Tree Analysis Scope</b>	
1	Faults associated uniquely with Li-ion cell chemistry.
2	Considers vehicle occupants and first responders.
3	Not design specific (i.e., cell, packaging, etc.)
4	Considers new product safety performance consistent with NHTSA FMVSS testing.
5	BMS includes all related components (e.g., thermocouples, relays, conductors, etc.)
6	Manufacturing defects identified but not expanded upon.
7	Design has been verified via DV (design validation) testing
8	Reliabilities and probabilities are not quantified

**Table 5 Fault Tree Analysis Scope**

The following list (Table 6), extracted from the original project solicitation, defines the normal and abnormal operating conditions and the failure modes of interest that were considered during the FTA assessment:

<b>RESS System Abnormal Operating Conditions</b>	
1	Vibration
2	Humidity and Moisture Exposure
3	Immersion
4	Thermal Control (charging, operation, crash)
5	Short Circuit (either/both sides of contactors)
6	Over Discharge/ Cell Reversal
7	External Thermal/Fire Exposure Resistance and Containment
8	RESS Enclosure Integrity (crash event, RESS thermal failure, foreign object penetration)
9	Thermal Shock
10	Drop (e.g., repair removal or install)
11	Mechanical Shock (crash pulse)
12	Mechanical Crush
13	High Voltage Withstand Capability
14	Thermal Runaway Propagation Resistance and Containment (with control system active)
15	Thermal Runaway Propagation Resistance and Containment (with active control system disabled)

**Table 6 RESS System Abnormal Operating Conditions**

## 5.2. Identified Fault Branches

With the scope and range of hazards to be considered defined in the foregoing, the upper levels of the FTA were set as shown in Figure 7.



Figure 7 FTA Upper Level Events

The assessments in the FTA are made on events occurring at the cell, module, pack or vehicle level and these are expanded further in the logic tree. Other faults types, such as issues with the design or environmental effects, are included in the fault tree for completeness but are not considered further in accordance with the scope outlined in Table 5 above. The lowest-level faults affecting hardware at the cell, module, pack, or vehicle level were assessed for priority of concern.

## 5.3. Developed FTA Structure

The following Figure 8 presents the overall tree structure developed by the project team. Because of the complexity, the figure is presented to provide a visual understanding of the tree structure and depth. An example of one branch of the tree is provided in Figure 9 and Figure 10 to provide an insight into the logic that is contained in the tree.

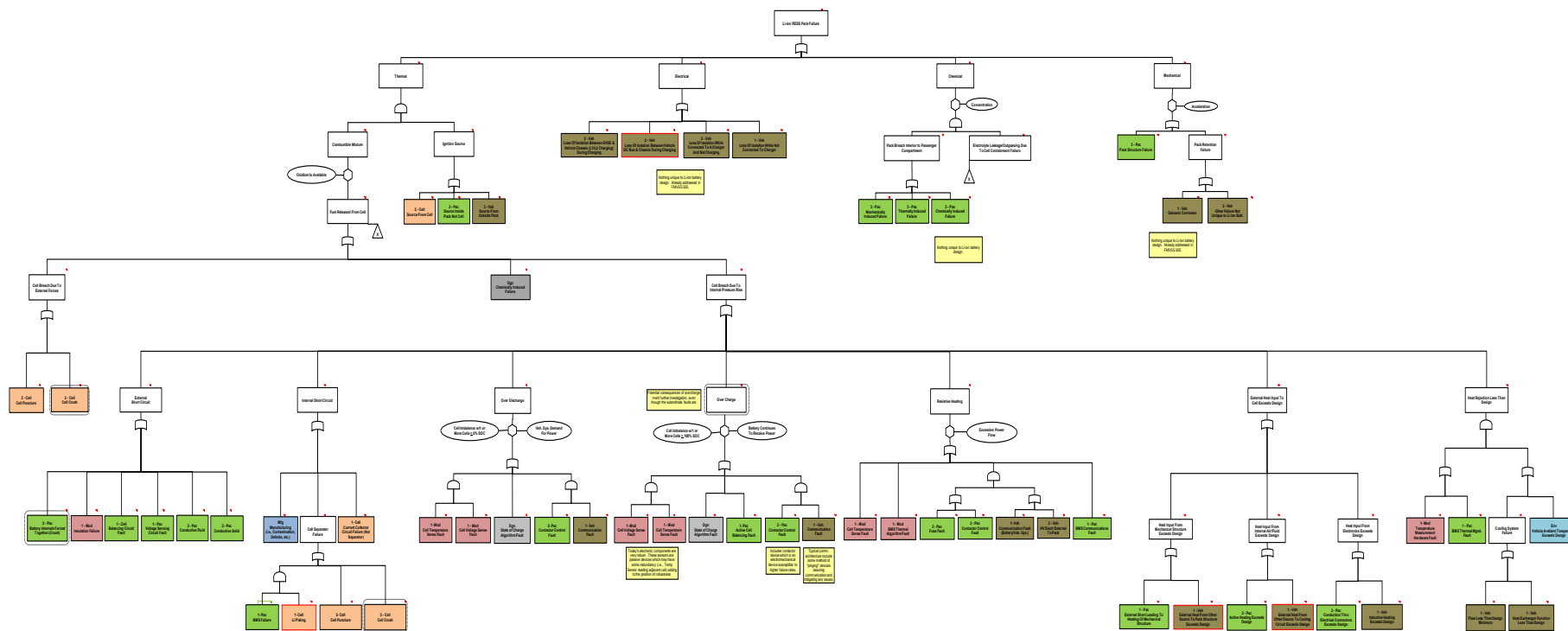


Figure 8 Fault Tree Layout

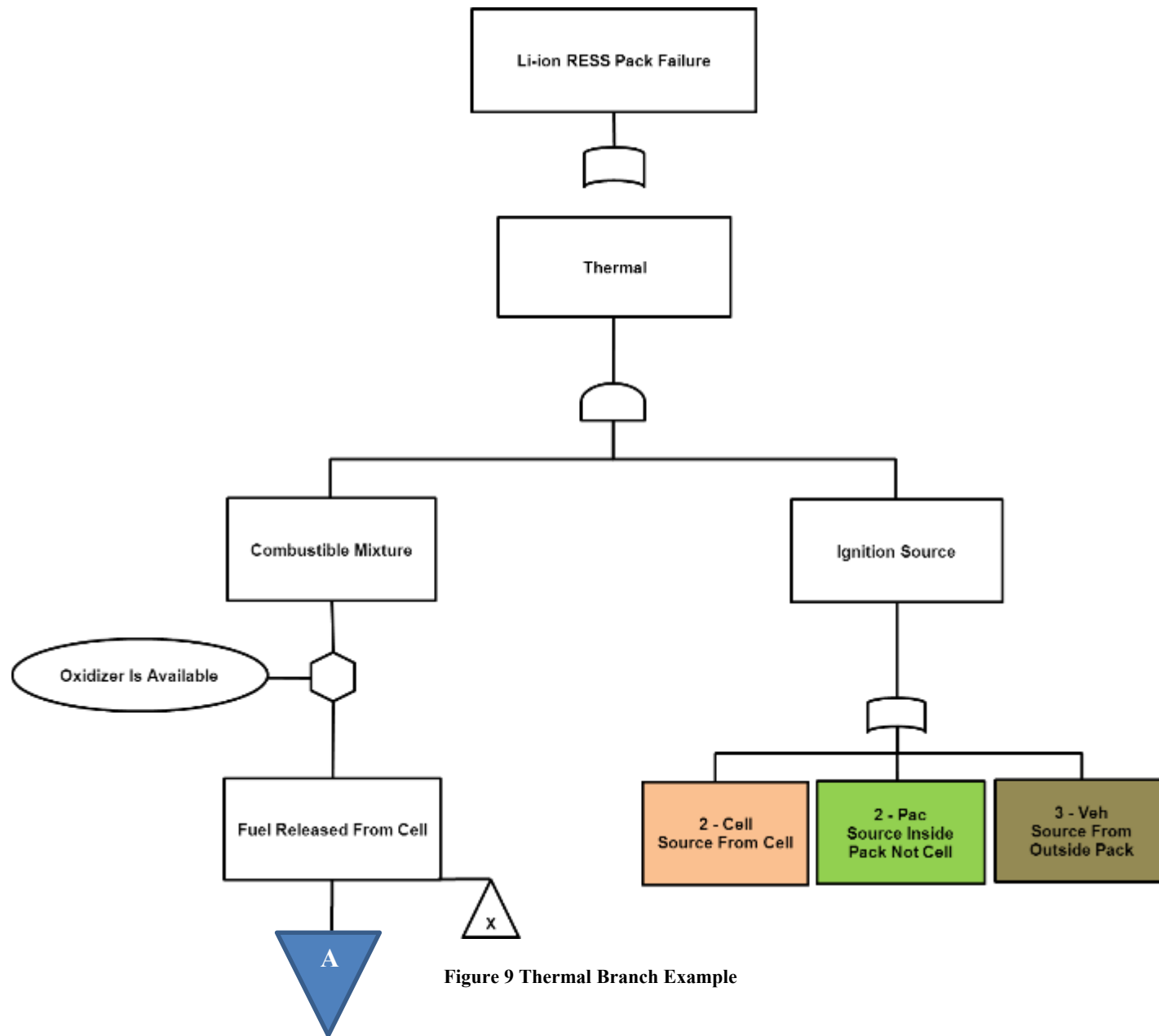


Figure 9 Thermal Branch Example

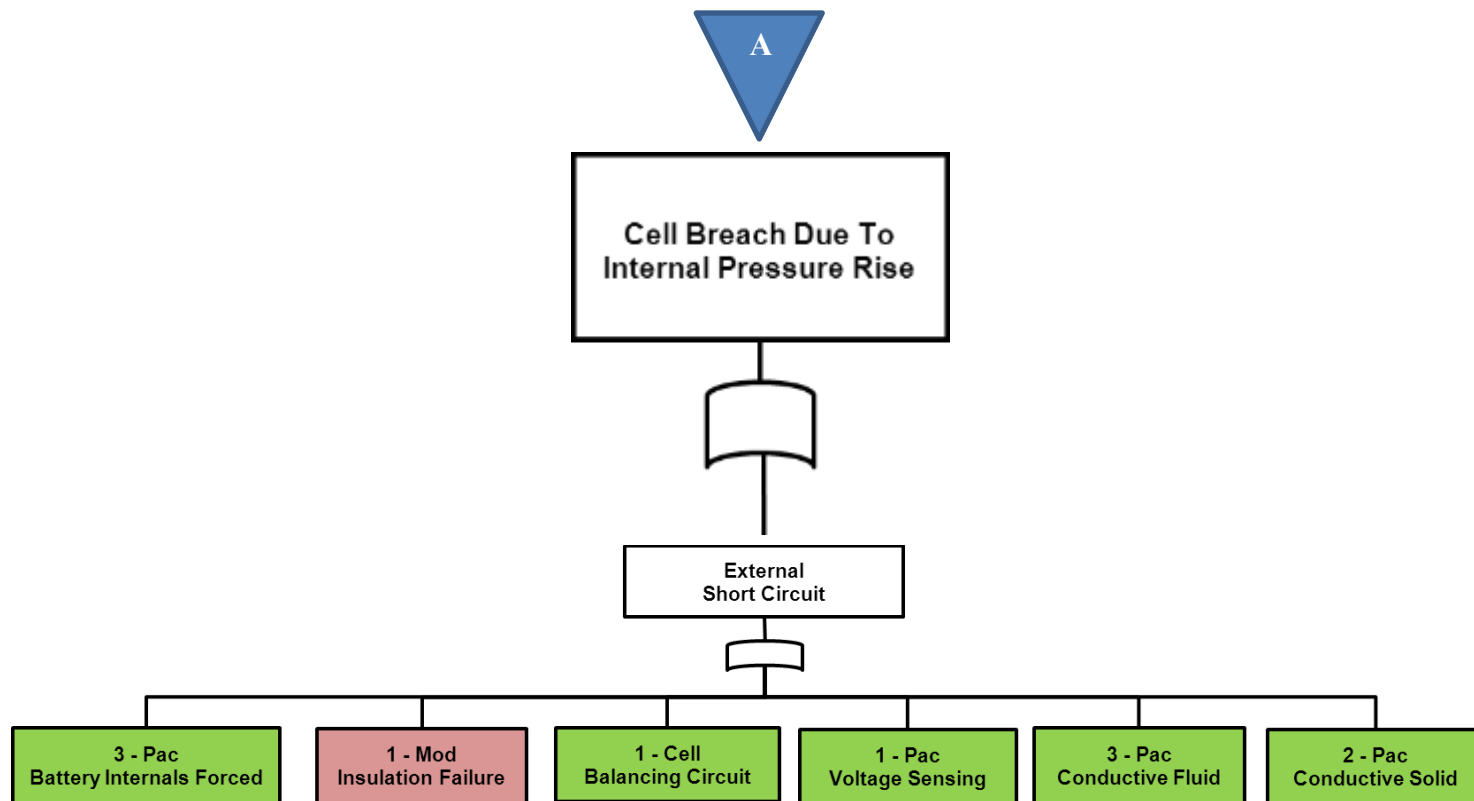


Figure 10 Thermal Branch Example (continued)

## 5.4. Defined Control Volume Boundary Diagram

The FTA process next focused on defining the control volume for the study (see Figure 11 FTA Boundary Diagram), which is centered on the lithium-ion battery pack. The control volume includes the cells, modules and the BMS. Note that the components included in the control volume of interest may not be contained within the pack enclosure, depending on the specifics of the design. This boundary diagram also shows the expected connections from the battery pack to the vehicle and external systems. The basic BMS is defined here to include controllers, sensors, and actuators.

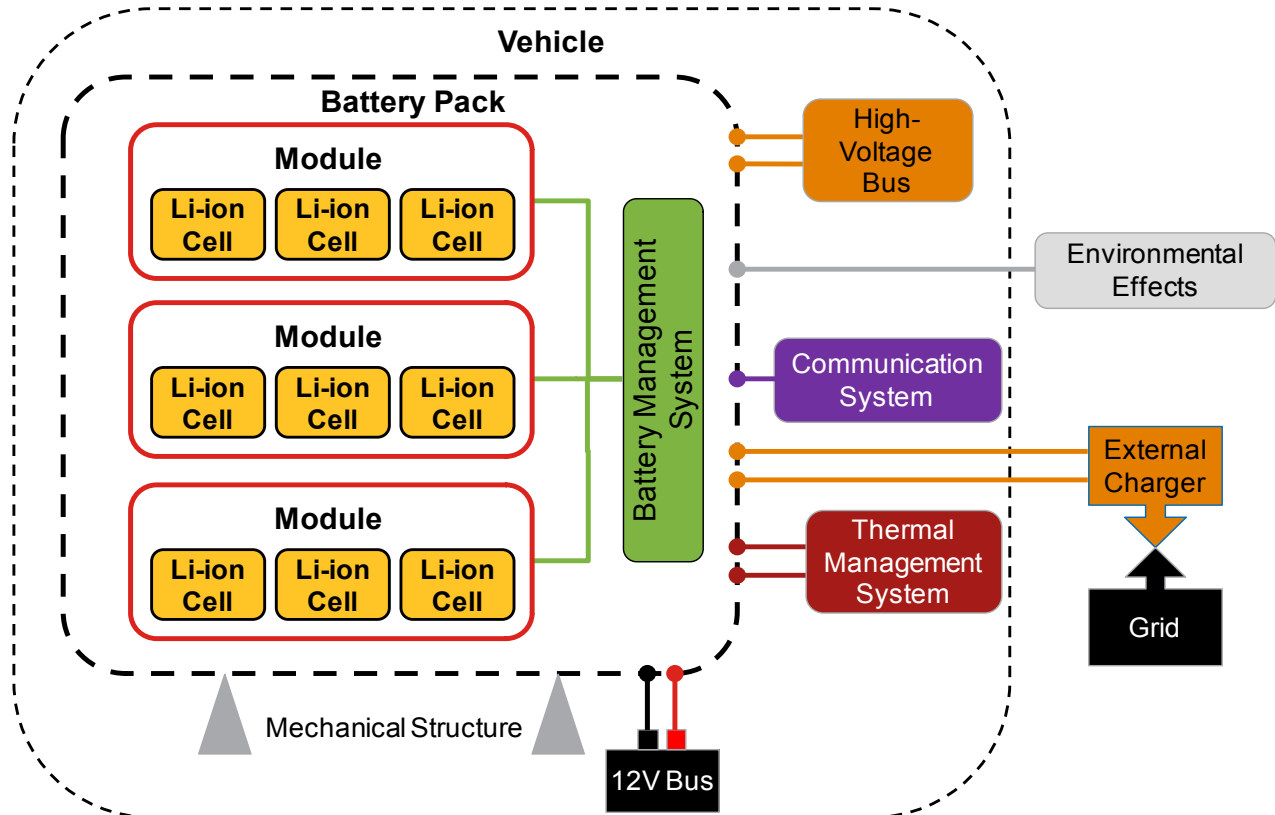


Figure 11 Fault Tree Analysis Boundary Diagram

Within the boundary diagram, the BMS is the key element for addressing the system under states of control and out of control that might take place in a RESS system. However, there is no established industry standard for the functions of the BMS. For this reason, the team explored and developed a definition of the functions of a BMS in terms of both minimal capabilities as well as reasonable expectations. The following illustrations are graphic representations of the work and ideas of the team in an iterative process of formulation. Figure 12 is provided to convey the evolution of the BMS boundary diagram. That figure presents a graphic illustration of the iterative process that was used to move to a consensus definition of the the functions and boundaries. Finally, Figure 13 and Figure 14 show two levels of boundaries used for this project: 1)



for a rudimentary, basic BMS and 2) a more advanced BMS as might be used in a well designed automotive system:

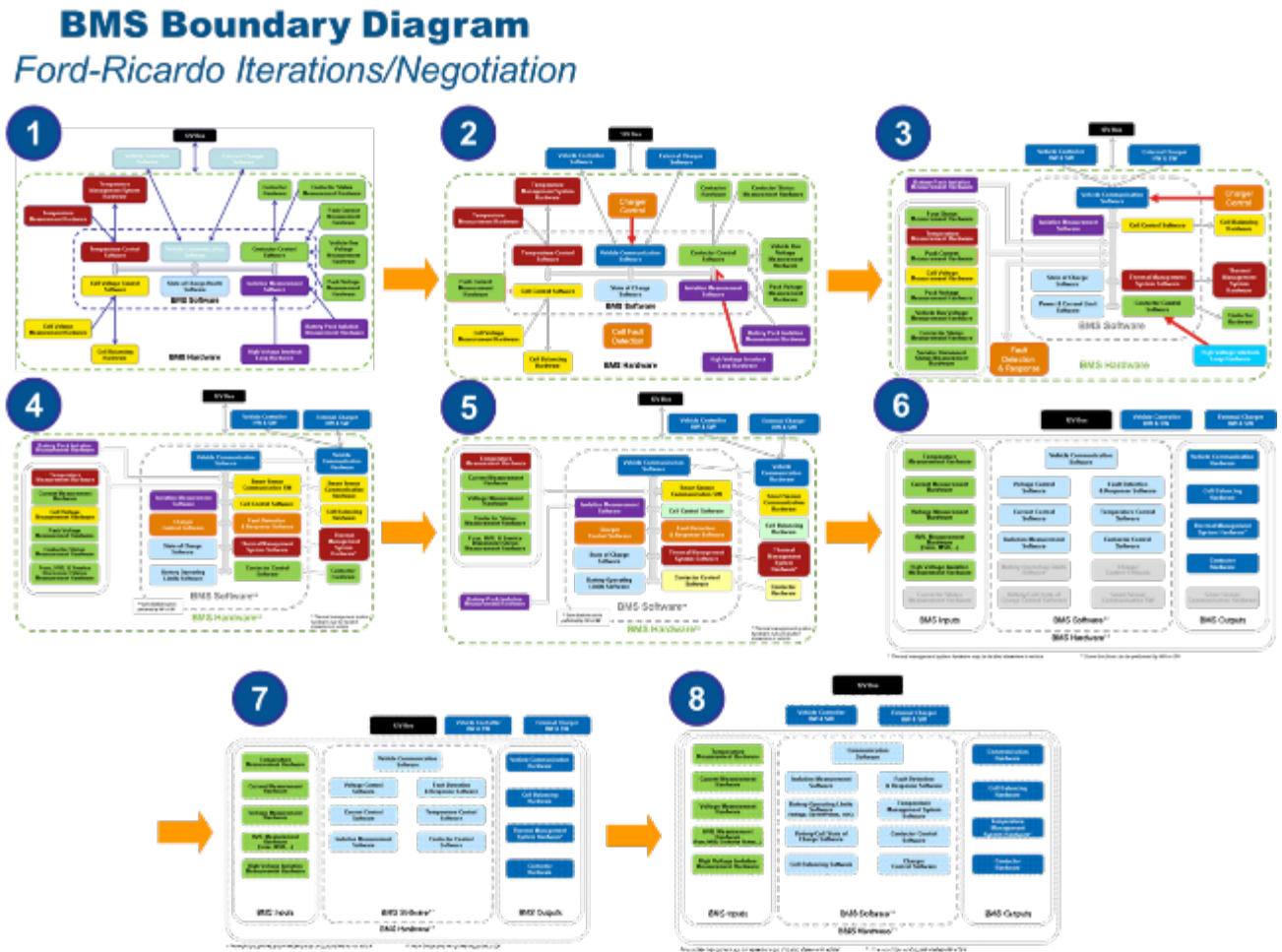


Figure 12 BMS Boundary Definition Iteration Process

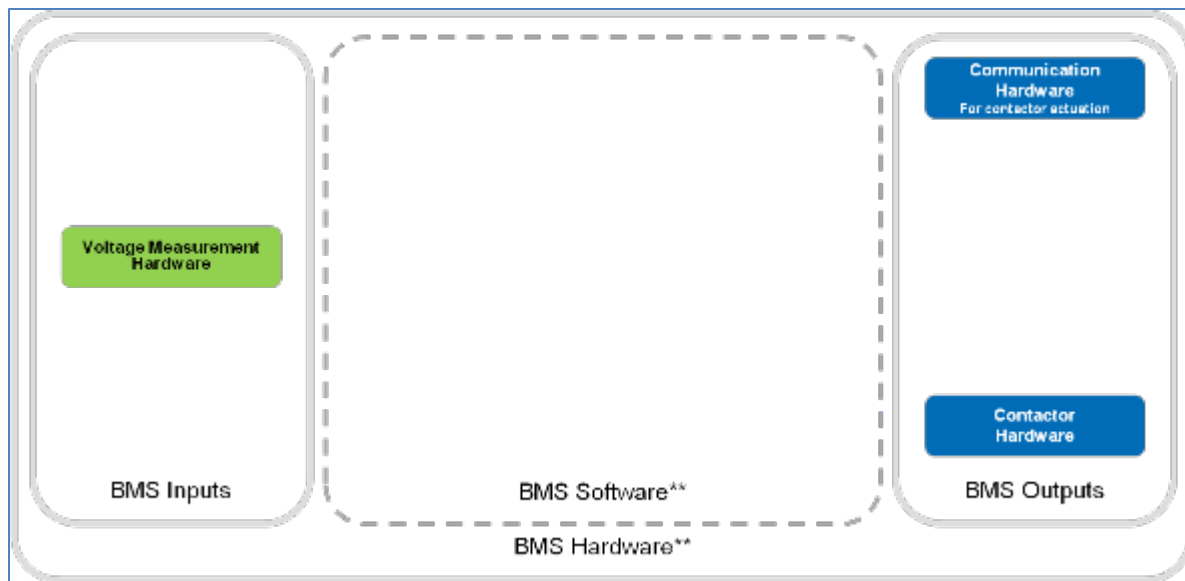


Figure 13 Basic BMS Functions and Boundaries

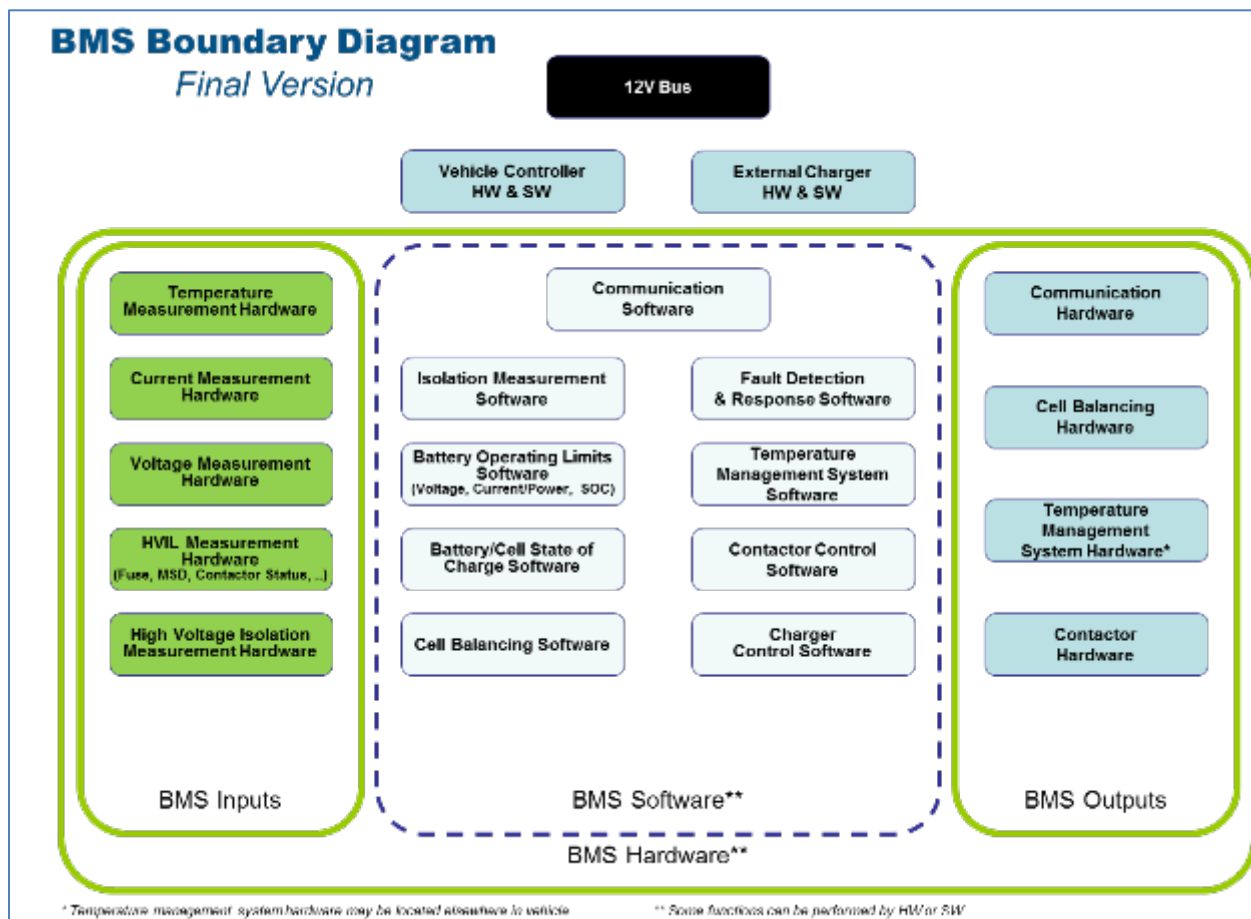


Figure 14 Advanced BMS Functions and Boundaries

The functions of the BMS were analyzed in detail to determine the most probable faults that might be considered to be failures in the control system. These faults were needed to develop scenarios of failure of the control system in parallel with a failure of a system component. The following, Table 7, is an excerpt from that analysis.

Type		Description		
Basic		No logical work around to eliminate this functionality in a lithium ion BMS and remain single fault tolerant.		
Advanced		Today's vehicles consistently have this functionality.		
Function	Label	Functions	Connected BMS Functions	Basic vs Advanced Functions
BMS Inputs	Temperature Measurement Hardware	Provide temperature input(s) to the BMS as required for proper operation. Inputs can include: - cells - coolant (liquid, air, other) - ambient air - heater - electronics - mechanical components	Communication software battery operating limits software battery/cell state of charge software fault detection and response software thermal management system software contactor control software communication hardware low voltage bus	All these functions are <u>advanced functions</u> . Temperature measurement allows broader pack performance based on the knowledge of actual temperatures. However, a safe battery pack design is possible without temperature measurement hardware. The performance would just be limited.
	Current Measurement Hardware	Provide current measurement inputs to the BMS as required for proper operation. Inputs can include: - High voltage bus current - External charger bus current - Heater current	Communication software battery operating limits software battery/cell state of charge software fault detection and response software contactor control software charger control software communication hardware low voltage bus	The fuse is a <u>basic function</u> .  The remaining functions are <u>advanced functions</u> used to extend the operating envelope of the battery pack and provide enhanced functionality such as improved vehicle range estimation.
	Voltage Measurement Hardware	Provide voltage measurement inputs to the BMS as required for proper operation. Inputs can include: - cell voltage - pack voltage - voltage across fuse/MSD - voltage across contactors	Communication software isolation measurement software battery operating limits software battery/cell state of charge software fault detection and response software contactor control software charger control software communication hardware cell balancing hardware contactor hardware low voltage bus	Cell voltage measurement is a <u>basic function</u> that is required on all lithium ion battery packs. Voltage measurement is required to prevent overcharge/over discharge for any secondary battery system that is repeatedly charged/discharged.  Pack, fuse, MSD, and contactor voltage measurements are <u>advanced functions</u> and enable diagnostics and performance controls that improve reliability and life but are not basic functions

Table 7 BMS Function Review Excerpt

## 5.5. Review of the Developed FTA

The completion of the FTA provided the identification of priority concerns that were to be considered in the development of testing possibilities. A priority ranking logic was applied to each terminal fault that fit the criteria spelled out in the FTA Scope. The ranking used the following logic (Table 8):

Priority of Concern	
3	Higher
2	Medium
1	Lower

Table 8 Fault Priority Ranking

With this approach, all of the initiating faults were classified to ensure that both existing and proposed testing adequately addressed the event. The following overview, extracted from the complete FTA, summarizes all of the key events that received priority ratings of 1, 2 or 3.

There were only seven higher priority faults. Medium priority was assessed for sixteen events and lower priority for twenty-six events. The six events of most concern define those assessments that of necessity would be addressed by the testing procedures to be developed. The following briefly discusses each:

### Higher Priority Cell Level Events

- Internal short circuit resulting from a cell separator failure caused by a Cell Crush

### Higher Priority Pack Level Events

- Chemical event involving a pack breach interior to the passenger department caused by a mechanically induced failure. This would be a pack containment failure due to crash.
- Chemical event involving a pack breach interior to the passenger department caused by a thermally induced failure. This would be a Pack containment failure due to high temperatures, not fire.
- Mechanical event caused by a pack structure failure, a failure of the structure due to crash.
- External short circuit caused by battery internal conductors being forced together in a crush event by mechanical forces on a pack.
- External short circuit caused by conductive fluid allowing a short circuit across cells.

### Higher Priority Vehicle Level Events

- Ignition of the vehicle from a source outside of the pack capable of igniting a combustible mixture

In addition to the higher priority events, a general overview of the FTA provided impetus to include some medium priority events due to the number of related potential events and industry experience and concern.

### **Medium Priority Charging Events**

Charging and discharging events were generally ranked as medium priorities largely because contemporary RESS and charger designs make it very difficult or improbable to cause. However, the severity of an event caused in this manner lead to the inclusion of such circumstances in the evaluation proposals. Of the sixteen identified medium priority events, six were clearly associated with charging and discharging while the remaining ten events were caused by a variety of unrelated factors. Here are those key overcharge/over-discharge events:

- As an ignition source, a Pack may become a concern from a source inside the Pack, but not from a cell.
- In a vehicle, a loss of isolation between EVSE and Vehicle Chassis (L1/L2 AC Charging) during charging. May produce a failure to protect a person contacting vehicle while charging.
- In a vehicle, a loss of isolation between vehicle DC bus and chassis during DC charging. May produce a failure to protect a person contacting vehicle while charging with DC.
- In a vehicle, a loss of isolation while connected to a charger and not charging may result in injury to person local to charging system or vehicle.
- In an overcharge, a contactor control fault could cause the contacts to fail to open.
- In an over discharge, a contactor control fault could cause the contacts to fail to open.

This FTA review ultimately supported the original assumption of this research that RESS crush and overcharge should be the focus of system assessments, but highlighted the need for the inclusion of potential short circuit events. As a result, procedures for each of these fault branches were developed.

## **6. Existing Standards Review**

In the development of testing recommendations for components and vehicles with RESS content, it is most reasonable to begin with an understanding of procedures that have already been accepted by the automotive industry. This review was intended to have two useful outputs.

- To the adequacy of existing procedures for use as a starting point for this project
- A comprehensive review identifying procedures improvement opportunities

This review allowed the team to identify the current recommended vehicle level test procedures, and apply or modify these procedures to the project's tests. The review was substantially com-

pleted in the first year of the project, but newly released draft standards were added to the assessment, as they were made available to ensure a comprehensive understanding had been developed (see Table 9).

### **6.1. Elements addressed**

Based on the review and the concurrent work performed in the development of the FTA, four focus areas were identified, as shown in Table 9. These areas define those tests that were to be studied in detail as applicable to the goals of this project. The four areas identified are the following.

1. Mechanical Integrity
2. Mechanical Shock
3. Overcharge
4. Short Circuit

An extract from the completed review is provided as an example of the survey review in Table 10. This example does not show the columns of the review matrix that identify the specific standards and their provisions (i.e., test procedure numbers) and is intended to show a result of the review.

The first column indicates the FTA path for a thermal event resulting from an internal short in a cell. The standards indicated in Table 10 (i.e., Freedom Car 5.2, UN 38.3 T5) were analyzed as applicable to this fault. The comments provide a succinct overview of the survey team's assessment of those existing test procedures and a judgment about the adequacy of the procedure identified as strong, marginal or weak as follows.

- **STRONG** - minimum one directly applicable (approach and implications replicate actual case) and adequately defined Test identified
- **MARGINAL** - minimum one directly applicable Test identified but insufficient in severity, process or requirements content
- **WEAK** - none directly applicable

The final column presents suggestions for further test development.

	Test Methods	NHTSA Solicitation	Freedom Car	SAE J2929	SAE J2464	UN 38.3	ISO 12405-1	QC-T 743-2006	ISO 12405-3	ECE R100
Mechanical	Mechanical Integrity	8, 12, 14	3.1	4.6	4.3.6			6.2.12.6 6.3.8.5	8.2	8D
	Penetration	8, 14	3.2		4.3.3			6.2.12.7 6.3.8.6		
	Immersion	3	3.4	4.4	4.3.5				8.3	
	Roll-Over		3.5		4.3.4					
	Drop	10	3.3	4.3	4.3.2	T6		6.2.12.4	6.3	
	Mechanical Shock	11	3.6	4.5	4.3.1	T4	8.4		6.2	8C
	Vibration	1		4.2.2		T3	8.2	6.3.7	6.1	8A
Thermal	Fire Exposure	7	4.2	4.7	4.4.1				8.4	8E
	High Temperature Storage		4.3					6.2.12.5 6.3.8.4		
	Cycle w/o Thermal Control	4, 8, 14	4.4	4.11	4.4.3				10.3	8I
	Thermal Shock	9	4.5	4.2.3	4.4.4	T2	8.3		7.1	8B
	Humidity Exposure	2		4.2.4			8.1		7.2	
	Passive Propagation	15,16			4.4.5					
Electrical	Overcharge		5.1	4.9	4.5.2	T7	9.3	6.2.12.2 6.3.8.2	10.1	8G
	Short Circuit	5	5.2	4.8	4.5.1	T5	9.2	6.2.12.3 6.3.8.3	9.1	8F
	Overdischarge	6	5.3	4.10	4.5.3	T8	9.4	6.2.12.1 6.3.8.1	10.2	8H
	High Voltage Exposure			4.13						
	Partial Short Circuit		5.4							
	Separator Shutdown				4.5.4					

Table 9 Industry Standards for RESS Assessments

<b>-System- FTA Cause&gt;&gt; Effect</b>	<b>Comments</b>	<b>Proposed Test Enhancement/ Recommendation</b>
- Cell - Current Collector Circuit Failure (Not Separator) >> Internal Short	STRONG -Reaction to hard shorts, and soft shorts depending upon magnitude and location, are well understood. Note: Many standards specify that an active BMS should protect device under study that therefore only validates on-board fault mitigating subsystems.	Recommended tests: Freedom Car 5.2 for hard short and UN 38.3 T5 for soft short. Test variables for possible proposed enhancements: range of external shorts from hard ( $R = 5 \text{ m}\Omega$ or $0.1 \cdot R_{DUT}$ ) to higher-than-soft-short resistance ( $R = 3.3 \text{ }\Omega$ ).

Table 10 Test Method Survey Example

The review included 38 specific elements, or combination of elements, identified in the fault tree as priority events. The completed review included 29 thermal events, 4 electrical events, 2 chemical events and 3 mechanical events. The existing standards were rated for applicability to the goals of this research in developing RESS tests methods at the vehicle or component level. Of the 38 elements, 12 were considered to have strong, well developed industry procedures for RESS assessment. There were also 10 considered to be outside of the scope of the project as defined in the FTA scope table. The remaining 16 events were considered to have a marginal relationship to the existing test standards.

**6.2. Test Types Identified from FTA**

The FTA process permitted the identification of priority faults to inform the test program development. At the beginning of the project it was assumed that crush and overcharge would be the faults of concern, but as a result of the FTA, short circuit was added to the analysis. For these three events, candidate test factors and measurable response variables were identified as shown in the following table (Table 11).

EUCAR Ratings as a response variable refer to established outcomes of specific tests. These are effective indicators of the outcome of a test, and also provide a guide to inform the test functions about how to proceed with tests when defined test factors limits have been reached. For reference, the following table (Table 12) summarizes those ratings.



Priority Faults	Candidate factors	Response variable
Crush	Displacement	Current
	Velocity	Voltage
	Orientation	Temperature
Overcharge	Current	EUCAR Rating
	Voltage	SOC %
	SOC%	Isolation
Short Circuit	Resistance	

Table 11 Priority Faults, Factors and Response Variables

EUCAR Ratings*		
0	No Effect	No Effect. No loss of functionality
1	Passive protection activated	No defect; no leakage; no venting, fire, or flame; no rupture; no explosion; no exothermic reaction or thermal runaway. Cell reversibly damaged. Repair of protection device needed.
2	Defect / Damage	No leakage; no venting, fire, or flame; no rupture; no explosion; no exothermic reaction or thermal runaway. Cell irreversibly damaged. Repair needed.
3	Leakage $\Delta$ mass < 50%	No venting, fire or flame*; no rupture; no explosion. Weight loss <50% of electrolyte weight (electrolyte = solvent + salt).
4	Venting $\Delta$ mass $\geq$ 50%	No fire or flame*; no rupture; no explosion. Weight loss of $\geq$ 50% of electrolyte weight (electrolyte= solvent + salt).
5	Fire or Flame	No rupture; no explosion (i.e., no flying parts).
6	Rupture	No explosion, but flying parts of the active mass.
7	Explosion	Explosion (i.e., disintegration of the cell).

\*FreedomCAR Manual of Test (2005)

Table 12 EUCAR Rating Summary

## 7. Overall Procedure Development

Through a series of team discussions, work was completed for the definition of initial test procedures designed to capture useful information in RESS crush, overcharge and short circuit faults. Attached as an appendix to this report are three generic standalone test procedures (Crush, Overcharge and short circuit) outputted from this project, what follows in this and subsequent sections is a working level description of their structure and specific implementation during this project.

It was determined that some procedures would be followed for all types of tests to ensure uniformity of data collection and enhanced ability to interpret results. These standards are shown here (Table 13).

Item	All
Setup	<ul style="list-style-type: none"> <li>• 100% State of Charge</li> <li>• Room Temperature</li> <li>• USABC Procedures as Control</li> </ul>
Response Variables	<ul style="list-style-type: none"> <li>• Current</li> <li>• Voltage</li> <li>• Temperature</li> <li>• EUCAR Rating</li> </ul>
Post-Test	<ul style="list-style-type: none"> <li>• Attempted Discharge</li> <li>• Observation Time and HW Securing Based on EUCAR Response</li> </ul>

Table 13 Procedures Applying to All Tests

For the defined Crush, Overcharge and short circuit tests, specifics for overall procedures were defined and these are summarized in the following Table 14.

Item	Crush	Overcharge	Short-Circuit
Test Factors	<ul style="list-style-type: none"> <li>• Orientation (X, Y, Z)</li> <li>• Continuous or Stop/Start</li> </ul>	<ul style="list-style-type: none"> <li>• Input (Current, Voltage and Power)</li> <li>• Continuous or Stop/Start</li> </ul>	<ul style="list-style-type: none"> <li>• Resistance (Hard, Medium, Soft)</li> </ul>
Test Extent	<ul style="list-style-type: none"> <li>• Displacement</li> </ul>	<ul style="list-style-type: none"> <li>• State of Charge</li> </ul>	<ul style="list-style-type: none"> <li>• Time</li> </ul>

Table 14 Specific Procedure Requirements for Crush, Overcharge and Short Circuit Tests

### 7.1. Global Test Procedure

Table 15 to Table 18 present those elements of test preparation and conduct that are common to defined testing including crush, overcharge and short circuit. These parameters and standards were set to ensure adequate data acquisition, uniformity in sample state at the start of tests and consistent identification of the end of the test. These procedures were reviewed in detail with each testing source and updates were made as practical implementation demands were assessed.

HW	Charge		Discharge	Shipping	
	Constant Current	Constant Voltage	Constant Current	Voltage	SOC %
A	1C to 4.15V	4.15V to 0.05C	1C to 2.8V	3.65	23
B	1C to 4.15V	4.15V to 0.05C	1C to 3.0V	3.69	45
C	1C to 3.65V	3.65V to 0.05C	1C to 2.0V	3.29	27

Table 15 Charge/Discharge State-of-Charge Parameters for Each Cell Type

Hardware		Nominal		Charge		Discharge	
Type	Arrangement	Voltage (V)	Capacity (Ah)	Constant Current	Constant Voltage	Constant Current	
A	String	1S4P	3.7	60	60A to 4.15V	4.15V to 3A	60A to 2.8V
	Module	4S5P	14.8	75	75A to 16.6V	16.6V to 3.75A	75A to 11.2V
	Pack	4S5P (x9) + 2S5P (x2)	148	75	75A to 166V	166V to 3.75A	75A to 112V
B	String	1S3P	3.6	60	60A to 4.15V	4.15V to 3A	60A to 3.0V
	Module	10S3P	36	60	60A to 41.5V	41.5V to 3A	60A to 30V
C	String	1S4P	3.2	72	72A to 3.65V	3.65V to 3.6A	72A to 2.0V
	Module	2S5P	6.4	90	90A to 7.3V	7.3V to 4.5A	90A to 4.0V
	Pack	36S5P	115.2	90	90A to 131.4V	131.4V to 4.5A	90A to 72V

Table 16 Charge/Discharge Procedures for Each Hardware Type

Variable	Details
Pre-test Setup	<ul style="list-style-type: none"> <li>All testing to begin with 100 percent SOC.</li> <li>Voltage and temperature data to be recorded for 2 minutes prior to testing beginning. Confirm open circuit voltage is within <math>\pm 0.02V</math> of 100 percent SOC during initial 2 minute datalogging, otherwise perform charge/discharge as necessary to ensure 100 percent SOC. Confirm ambient temperature is <math>25^{\circ}C \pm 3^{\circ}C</math>, otherwise wait until temperature stabilizes before performing test.</li> </ul>
Data Sampling	<ul style="list-style-type: none"> <li>Voltage, current and temperature (Rate 10 Hz), except hard short-circuit that requires 100Hz</li> <li>Maintain a power supply connection with a minimum rating of current carrying cabling of 1C to enable post-test discharge. In the case of Overcharge, this cabling maybe the same as that used to perform the test. In the case of short circuit, this power supply connection must be different than the connection used to trigger the test condition.</li> <li>Two (wide view of test chamber and focused view of test hardware) color video recordings to be taken and recorded. Test time to be synched between video recordings and datalogs.</li> </ul>
Post-test	<ul style="list-style-type: none"> <li>Post-Test: Monitoring time dependent on response. <ul style="list-style-type: none"> <li>If Response <math>\leq</math> EUCAR 2 <math>\rightarrow</math> Monitor data for 30 minutes.</li> <li>If Response = EUCAR 3 or 4 <math>\rightarrow</math> Monitor data for 2 hour.</li> <li>If Response <math>\geq</math> EUCAR 5 <math>\rightarrow</math> Monitor data for 30 minutes.</li> <li>After monitoring, evaluate if <math>dT/dt \leq 0^{\circ}C/min</math> and <math>dV/dt \leq 1mV/min</math>, then attempt discharge to 0 percent SOC at 1C. If this fails, move to safe HW.</li> </ul> </li> <li>To Safe HW <math>\rightarrow</math> If voltage signal still valid, attempt 1C discharge, if that fails then apply fixed load resistor to discharge HW. If this also fails, then crush or immerse in salt water bath to safe. If response <math>&lt;</math> EUCAR 2 and discharge to 0 percent SOC is possible, then recharge to shipment SOC percentage for possible re-use.</li> </ul>
Temperature	$25^{\circ}C \pm 3^{\circ}C$
Spark	Not present unless significant cell venting occurs and ignition is desirable for facility considerations

Table 17 Global Test Procedures Details

Test	Charge Method	Procedure	
		Channels	Rate (Hz)
Global	Voltage	57	10
	Current	1	10
	Temperature	139	10
	Resistance	1	10
Hard Short-Circuit	Voltage	57	100
	Current	1	100
	Temperature	139	100
Crush	Force	1	10
	Displacement	1	10
	Trigger	1	10

Table 18 Data Sampling Equipment

## 7.2. Overcharge Procedure

With the recognition of the global procedures discussed above, the specifics for overcharge testing factors identified in Table 14 were more specifically defined and detailed in the following Table 19:

Variable	Level	Details
Pretest	Constant	<ul style="list-style-type: none"> <li>Perform 1 full charge/discharge cycle to confirm capacity and calibrate state-of-charge calculation. Wait at least 2 hours, or until hardware cools down to within 3° C of ambient (whichever is longer).</li> </ul>
Power Input	Factor (3)	<ul style="list-style-type: none"> <li>Current – must have a compliance voltage <math>\geq 60V</math> for strings, and <math>\geq 600V</math> for modules or packs <ul style="list-style-type: none"> <li>32A for continuous</li> <li>1 C-rate at 50 percent time (0.5C effective) for stop/start</li> </ul> </li> <li>Voltage – must have a current corresponding to <math>\geq 1</math> C-Rate for the test hardware <ul style="list-style-type: none"> <li>350V for continuous</li> <li>350V at 50 percent for stop/start</li> </ul> </li> <li>Power – must have a compliance voltage <math>\geq 60V</math> for strings, and <math>\geq 600V</math> for modules or packs and current corresponding to <math>\geq 1</math> C-Rate for the test hardware <ul style="list-style-type: none"> <li>6.3kW for continuous</li> <li>6.3kW at 50 percent time for stop/start</li> </ul> </li> </ul>

Variable	Level	Details
SOC Profile	Factor (2)	<ul style="list-style-type: none"> <li>• Continuous</li> <li>• Stop/Start (20 Intervals) <ul style="list-style-type: none"> <li>• Current: 3 minutes at 1 C-Rate, 3 minutes rest for 6 total minute intervals, repeat x20. Cumulative effective rate is 0.5 C-Rate over 2hours</li> <li>• Voltage: 3 minutes at 350V, 3 minutes rest for 6 total minute intervals, repeat x20. Cumulative test time is x2 continuous Voltage condition.</li> <li>• Power: 3 minutes at 6.3kW, 3 minutes rest for 6 total minute intervals, repeat x20. Cumulative test time is x2 continuous power condition.</li> </ul> </li> </ul>
End Point	Constant	<p>Whichever First:</p> <ul style="list-style-type: none"> <li>• <math>\geq</math> EUCAR 5 (No Applied Spark)</li> <li>• <math>\geq</math> 200%SOC</li> <li>• Power Supply Voltage Reached</li> </ul>

**Table 19 Overcharge Test Procedure**

The input condition for the overcharge test procedure was modeled on the control behavior of modern plug in vehicle chargers. By detecting the voltage of the battery to be charged, chargers commonly enter into either constant current, voltage or power modes. This test procedure was written to study the impact of a fault resulting in staying in either of the three charge modes. As a practical matter, to drive a battery to a target compliance voltage can require a very large amount of current flow. As a result, each test site’s charge/discharge equipment’s current capability became the deterministic factor during planned constant voltage and constant power testing. Due to testing reality, the original image of constant current, voltage and power testing was reframed around a wide range of constant current testing. In this way, the real world intent that was the target of experimentation is still probed and reconciled with the testing realities of multiple test sites’ capabilities.

**7.3. Crush Procedure**

With the recognition of the global procedures discussed above, the specifics for crush testing factors identified in Table 14 were more specifically defined and detailed in the following Table 20 and Table 21.

The impact of the direction of crush is one of the key factors that were explored in the crush testing. To ensure a common directional language amongst different hardware designs and test sites, the following axes assignments were made in Table 21. Additionally, the importance of providing mechanical restraints in the Y and Z-axis direction was also determined, an example of which for a Type A String in Y-Axis crush is shown in Figure 15.

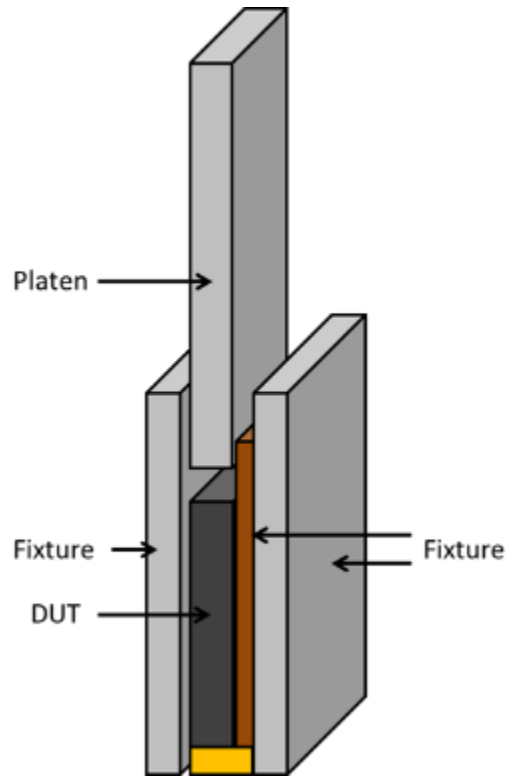


Figure 15 Crush Fixture Example

The platen to be used is described in Figure 16 and features one 75 mm radius hemisphere that in depth must span in excess of the test hardware.

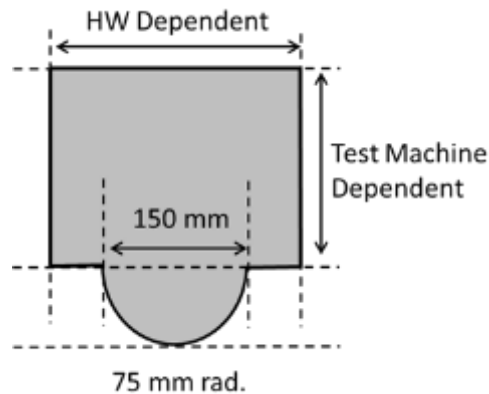


Figure 16 Crush Platen

Although Table 21 defines the direction of crush, it is still possible to rotate the crush platen while meeting all prescribed test parameters as is shown in Figure 17 with the example of a Type A String, X-Axis scenario. When crushing with  $90^\circ$  (angle between the long direction of the test hardware in the YZ plane and the long axis of the platen hemisphere) rotation it is possible to fully engage the test hardware with the platen hemisphere. Rotating the platen by  $0^\circ$  results in the platen not only engaging the cell hardware (dark grey), but also the corresponding busbar (gold).

During the course of test procedure development test sites were instructed to avoid hitting the busbars to allow the cell mechanical response to be the test focus.

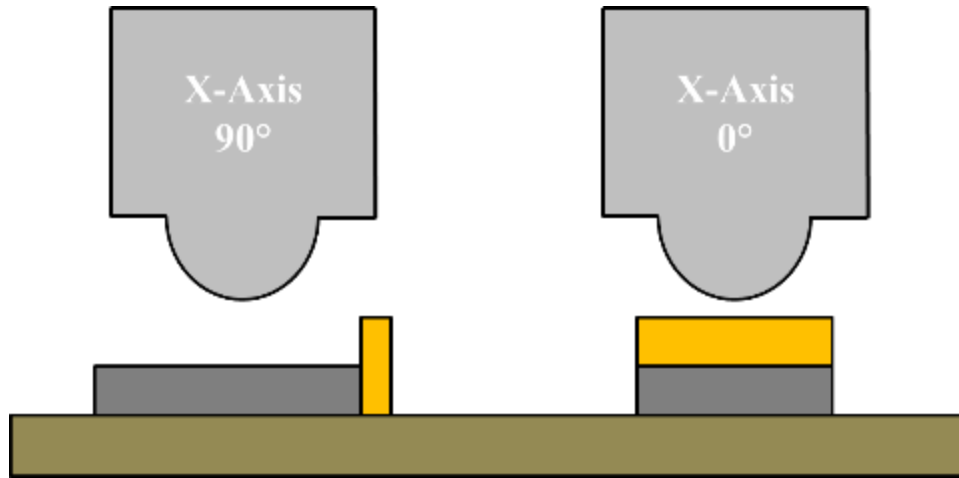


Figure 17 Platen Rotation Options

Variable	Level	Details
Data Sampling	Constant	<ul style="list-style-type: none"> <li>Force and displacement (Rate 10 Hz). Additionally a displacement trigger variable shall be included in the data output if crush and electrical system are not interlinked for time synching purposes.</li> <li>Resistance using 1 kHz AC (Rate 10 Hz, independent data stream) recorded during non discharge/charge stages of procedure.</li> </ul>
Orientation	Factor (3)	<ul style="list-style-type: none"> <li>X-Axis: Into large plane</li> <li>Y-Axis: Into terminals (Constraint Jig Parallel to the Y-Axis is added during Crush)</li> <li>Z-Axis: Other (Constraint Jig Parallel to the Z-Axis is added during Crush)</li> </ul>
Load	Constant	<ul style="list-style-type: none"> <li>Minimum load capability of crush machine to be <math>\geq</math> x1,000 test article weight</li> </ul>
Speed	Constant	<ul style="list-style-type: none"> <li>5 mm/sec</li> </ul>
Motion	Factor (3)	<ul style="list-style-type: none"> <li>Continuous to 85 percent of initial test article dimension</li> <li>Start/Stop (3 Intervals): 15%, 50 percent and 85 percent of initial test article dimension                             <ul style="list-style-type: none"> <li>At each of the 3 intervals (15%, 50% and 85%) keep crush load applied and hold for 30min collecting data <math>\rightarrow</math> if voltage signal valid attempt to discharge (1minute using conditions in Table 16) with crush load applied. If discharge successful <math>\rightarrow</math> rest 1 min and collect data <math>\rightarrow</math> attempt charge (1minute using conditions in Table 16) with crush load applied. If charge successful, then rest 1 min and continue crush to next displacement.</li> </ul> </li> </ul>



Variable	Level	Details
		<ul style="list-style-type: none"> <li>Start/Stop (20 Intervals): crush 5 percent of initial test article dimension and repeat x20 <ul style="list-style-type: none"> <li>Procedure contingent on minimum machine step limit <math>\leq 2</math> mm</li> <li>At each of the 20 intervals, keep crush load applied and collect data such that each interval's total (compression time + hold time) time is 6 minutes for a total test performance time of 120 minutes. During each hold interval, if voltage signal valid attempt to discharge (1 minute using conditions in Table 16) with crush load applied. If discharge successful <math>\rightarrow</math> rest 1 min and collect data <math>\rightarrow</math> attempt charge (1 minute using conditions in Table 16) with crush load applied. If charge successful, then rest 1 min and continue crush to next displacement interval.</li> </ul> </li> </ul>
Platen	Constant	<ul style="list-style-type: none"> <li>Single contour (75mm radius, length 0mm) version of SAE J2464 Platen (3 contour). Platen length should be such that it overhangs all test hardware.</li> </ul>
End Point	Constant	<p>Whichever occurs first*:</p> <ul style="list-style-type: none"> <li><math>\geq</math> EUCAR 5 (No Applied Spark)</li> <li><math>\geq</math> Target Displacement percentage</li> <li>Machine Load Limit Reached</li> </ul>
Post-test	Constant	<ul style="list-style-type: none"> <li>Refer to Global Test Parameters</li> <li>During attempts to discharge post-test (if a voltage signal is valid), first attempt with compressive load present. If that fails, then remove load and try again while recording compressive load value, load duration and hardware temperature at time of removal.</li> </ul>

Table 20 Crush Test Procedure

Axes	Definition
X	Perpendicular to the largest plane of the hardware's cells, i.e., into the broad plane of the electrodes
Y	Perpendicular to the plane containing the hardware's terminals
Z	The third axes not defined by X or Y. Often known as the thin edge of the cells.

Table 21 Crush Axe Definitions

A visual summary of how the axis definition shown in Table 21 was applied to each hardware type is shown in Table 22.

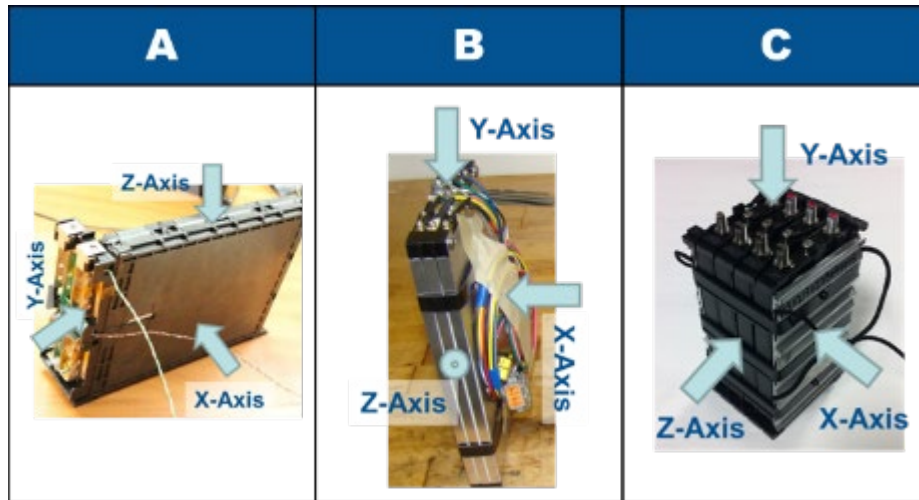


Table 22 Crush Axis by Hardware Type

#### 7.4. Short Circuit Procedure

With the recognition of the global procedures discussed above, the specifics for short circuit testing factors identified in Table 14 were more specifically defined and detailed in the following Table 23 and Table 24.

Variable	Level	Details
Data Sampling	Constant	Voltage, current and temperature at 100 hz for hard condition and 10 hz for medium and soft conditions.
Resistance	Factor (3)	Resistance of device under test ( $R_{DUT}$ ) to be determined by measuring 1 kHz AC at 100 percent SOC <ul style="list-style-type: none"> <li>• Hard (<math>R_{DUT} \times \sim 10</math>)</li> <li>• Medium (<math>R_{DUT} \times \sim 30</math>)</li> <li>• Soft (<math>R_{DUT} \times \sim 100</math>)</li> </ul>
Applied Short Time	Constant	<ul style="list-style-type: none"> <li>• Hard and medium: 10 minutes</li> <li>• Soft: 2 hours</li> </ul>
End Point	Constant	Whichever First: <ul style="list-style-type: none"> <li>• Applied short time limit</li> <li>• <math>\geq</math> EUCAR 5 (No Applied Spark)</li> </ul>
Post-Test	Constant	Refer to Global Test Parameters

Table 23 Short Circuit Test Procedure

Hardware Type		$R_{DUT}$ (m $\Omega$ )	Test Condition Label (m $\Omega$ )		
			Hard	Medium	Soft
A	String	0.3	3	9	30
	Module	1.3	13	39	130
	Pack	19.8	198	594	1,980
B	String	0.5	5	15	50
	Module	4.8	48	144	480
C	String	0.5	5	15	50
	Module	0.8	8	24	80
	Pack	15	150	450	1,500

Table 24 Target Short Circuit Testing Resistances

## 8. Test Material Designs

### 8.1. Test Hierarchy

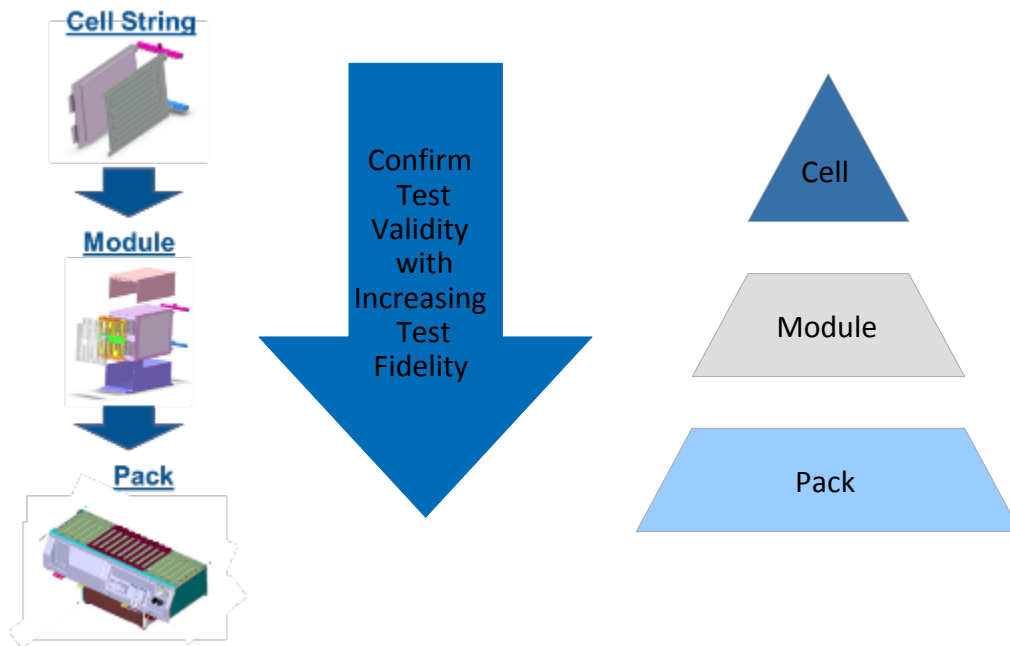


Figure 18 Device Testing Overview

A hierarchical approach was followed to develop meaningful test boundaries and metrics based on known limits. The following graphic (Figure 18) describes this approach. This plan was implemented using components from commercially representative electric vehicle systems, modified and assembled to provide testable samples and included use of battery cells assembled into basic strings, modules made up of the basic strings and ultimately, packs made up of modules and a rudimentary BMS. The functions that were enabled on the rudimentary BMS were primarily for contactor control to safely secure the hardware during storage and shipment to the test sites.

### 8.2. Test Hardware Objectives

The overall objective of test hardware selection and design was to capture critical metrics informing RESS safety and supporting predictive capability. The assumption in the original program was that testing would focus around the Type A hardware. With the approved program modification in December 2012, the test scope was expanded to include the Type B and C hardware. By incorporating two other hardware types, it was judged that more robust and broadly applicable test data could be generated.

### 8.3. Hardware Selection and Preparation

During the hardware selection process, a mixture of hardware size (weight, volume and energy content) and construction (manufacturer, chemistry and packaging) were prioritized. Table 16

describes the electrical arrangements of each hardware type, whereas Table 25 further describes each unit on the basis of their constituent cells. Additionally, Table 26 describes the overall mechanical size and image of each hardware type.

Type	Cell Packaging	Cathode	Capacity (Ah)	Nominal Voltage (V)
A	Pouch	Blend (LiMn <sub>2</sub> O <sub>4</sub> + LiNiMn-CoO <sub>2</sub> )	15	3.7
B	Pouch	LiNiMnCoO <sub>2</sub>	20	3.6
C	Prismatic	LiFePO <sub>4</sub>	18	3.2

Table 25 Hardware Type Cell Description

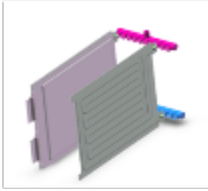

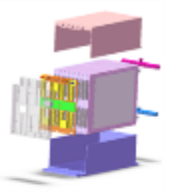
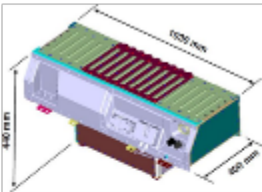
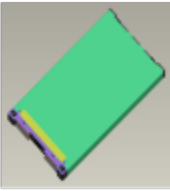
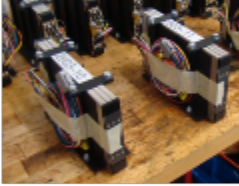




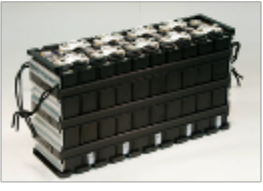

Type	Cell	Strings	Module	Pack
A				
		<b>2kg, 2L</b>	<b>13kg, 9L</b>	<b>150kg, 181L</b>
B				
		<b>2kg, 1L</b>	<b>17kg, 10L</b>	
C				
		<b>3kg, 2L</b>	<b>7kg, 4L</b>	<b>200kg, 295L</b>

Table 26 Hardware Type Overall Description

## 8.4. Type A

### 8.4.1. Stacked, Banded, Supported

Shown in the following illustrations (Figure 20 and Figure 19), Type A strings were built in three different configurations to accommodate the needs of the testing performed. The figure and picture on the left is a version in which the cells are stacked together to make a string. This form was useful for crush testing perpendicular to the large face of the cells (the X direction, see Table 21). However, when the crush was performed on the thinner sides of the cells as in the central figure and picture, and into the terminal ends (Y and Z directions, see Table 21), a band was added to keep the cells from splaying during the crush. The right figure shows the addition of

metal support plates to restrain the cells from expanding during the overcharge and short-circuit tests.

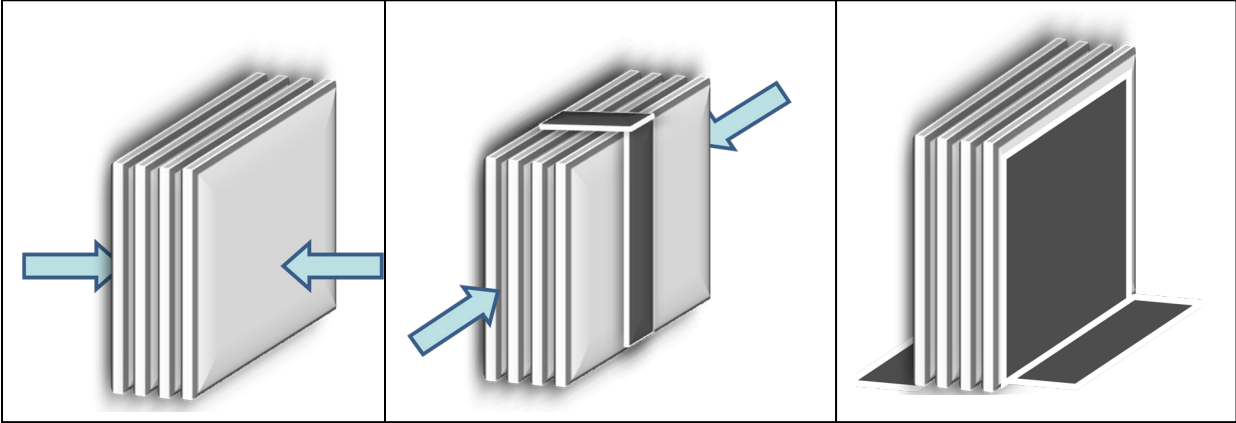


Figure 19 Type A String Configuration Photos

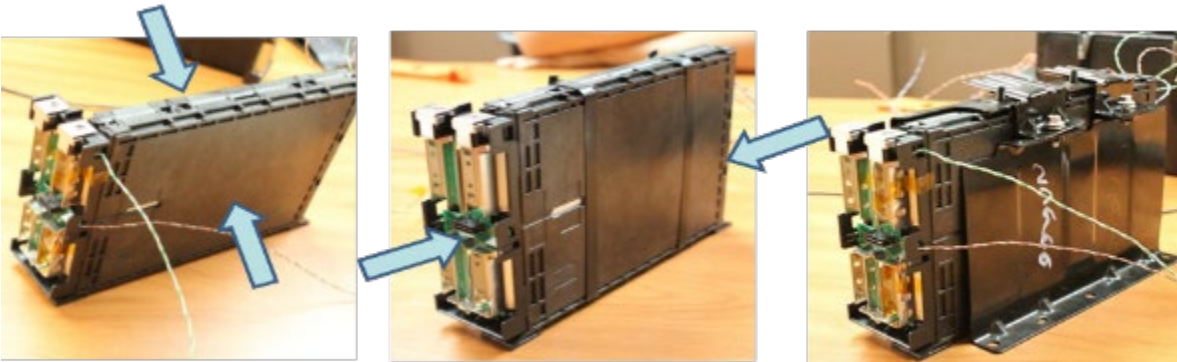


Figure 20 Type A String Configurations

## 8.5. Type B

Type B hardware, shown in Figure 21 and Figure 22, is a lithium ion battery with  $\text{LiNiCoMnO}_2$  based cathode chemistry in a pouch form factor. Each cell is housed in an aluminum frame. The frames are grouped as either strings or modules as shown in the figures.

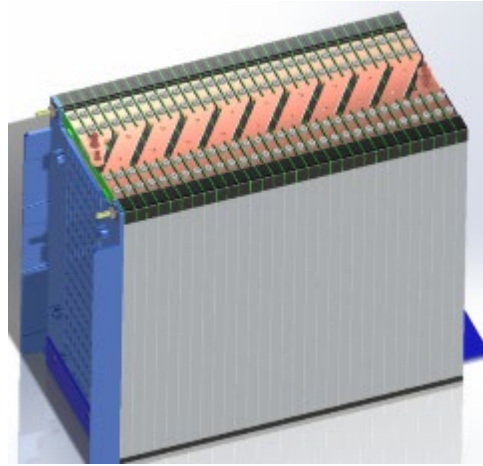


Figure 21 Type B Module



Figure 22 Type B String (Banded (L) End Plate (R))

## 8.6. Type C

Type C hardware, shown in Figure 23 and Figure 24, is a lithium ion battery with a LiFePO<sub>4</sub> based cathode chemistry in a prismatic form factor. Each cell is housed in a plastic frame and these were assembled as strings and modules as seen below.



Figure 23 Type C String



Figure 24 Type C Module

Type C cells were used to construct a functional battery pack with capacity approximating the Type A packs. Extensive design work was conducted to develop an enclosure, basic connections and disconnects. The design of the Type C pack, a 90Ahr 115.2V nominal battery pack containing 180 Type C cells in a 36S5P configuration was completed using the following activities:

- Selection of a pack concept
- Development of high voltage (HV) and low voltage (LV) cabling
- Mounting of ancillary components such as contactors and pre-charge resistor
- Development of module retention based on Type C supplier recommendations
- Pack enclosure
- Pack enclosure structural analysis

The Type C pack design was detailed and all components ordered for a build start in mid-October 2013. Details of the pack design are shown in Figure 25.



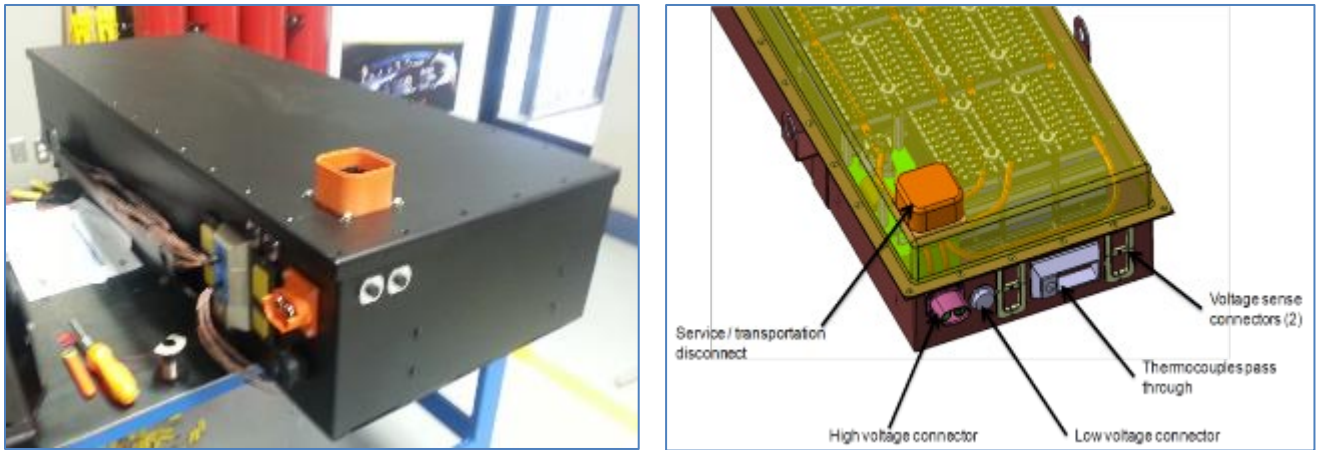


Figure 25 Type C Pack Feature

## 9. Testing

A key element of this research was the demonstration and evaluation of the test procedures that were proposed and developed. In all cases, these tests are considered abuse tests and the outcome of each had the potential of energetic component failures. This type of specialized testing is only performed at a handful of sites in the North America (see Figure 26). The team identified all testing sources in the United States and Canada that offered battery abuse testing at the size and scale of this program. An assessment procedure to determine which test site had the capability to do all or at least a significant portion of the proposed testing program was created.

With the potential sources identified, the Ford team undertook an assessment process that considered published capabilities, site visits and a ranking process. This was followed by the development of a detailed statement of work that was presented to those sources judged to best suited to the project. Each source was asked to provide a statement of their ability to perform the requested tests, offer comments about the proposed procedures and to provide a cost quotation. The following sections provide a more detailed overview of this process.

### 9.1. Site Assessment Procedure

A large variety of test sites throughout North America were considered as candidate locations for this project. The following is the list of the site and locations visited by representatives of the project team.

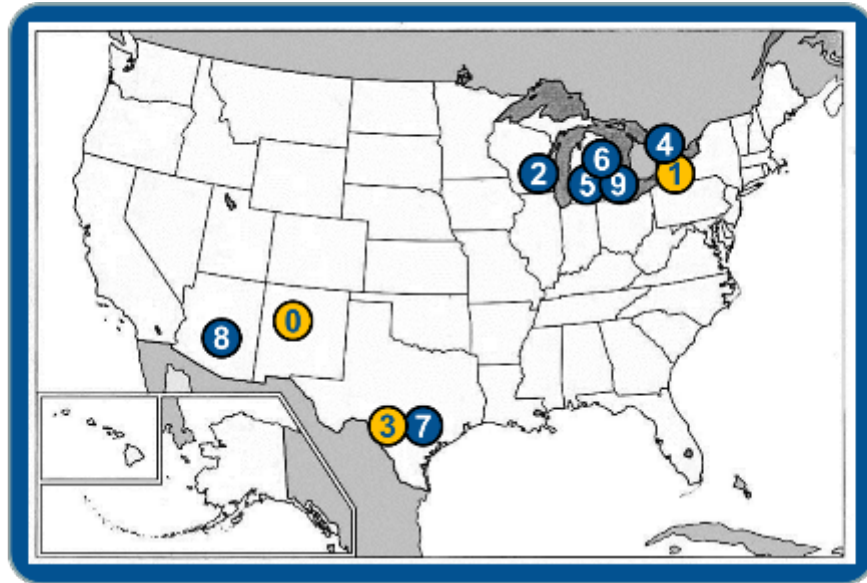
- Sandia National Lab (Albuquerque, NM)
- MGA Research
  - Akron, NY
  - Burlington, WI
- Southwest Research Institute (San Antonio, TX)
- TUV Sud
  - Auburn Hills, MI
  - New Market, ON
- Intertek
  - Plymouth, MI
  - San Antonio, TX
- Exponent (Phoenix, AZ)
- Element (Warren, MI), formerly Detroit Test Labs

Each of the candidate test sites was visited and considered as a possible test site for this project. Each Test Site was evaluated on the following criteria shown in Table 27:

Category	Feature		Factor
Non-Abuse	Experience	Cell/Module	1
		Pack	2
	Equipment	Cell/Module	3
		Pack	4
Mechanical Abuse	Experience	Cell/Module	5
		Pack	6
	Equipment	Cell/Module	7
		Pack	8
Electrical Abuse	Experience	Cell/Module	9
		Pack	10
	Equipment	Cell/Module	11
		Pack	12
Advanced Abuse	Dedicated Rooms	Cell/Module	13
		Pack	14
	In-House Design Capability		15
	Experience		16
Logistical	Proximity To Dearborn		17
	Existing Relationship With FMC		18

**Table 27 Factors used to Evaluate Candidate Test Sites**

A summary of the test lab locations considered and the progress from visit to quote to selection is shown in Figure 26. From the review of these sites and assessment by team personnel, it was possible to rank each of the candidate test sites. Based on this assessment of the 10 test locations to meet the needs of the program, requests for engineering cost estimates to perform the defined abuse testing were solicited from SNL, MGA Research, Southwest Research Institute and TUV Sud.



	0	1/2	3	4/5	6/7	8	9
	SNL	MGA	SwRI	TUV Sud	Intertek	Exponent	Element
Reviewed	•	•/•	•	•/•	•/•	•	•
Quoted	•	•/•	•	•/•			
Selected	•	•/-	•				

Figure 26 Test Sites Considered

The four test sites that provided estimates were each provided a project testing description that included the current test procedures and plan. Using the technical performance details provided by each test site, it was possible to compare their capabilities to perform the program’s three test types: crush, overcharge and short circuit. A comparison of the four quoting test sites’ capabilities is shown in Table 28. Based on these cost estimates and by matching the project testing needs with capabilities, three test locations (SNLs, MGA Research, and Southwest Research Institute) were ultimately sourced.

It can be noted as a result of this review that there are very few domestic or North American testing sources capable of performing the kinds of automotive battery abuse testing required for full automotive systems evaluations.

Test	Parameter	MGA	SwRI	SNL	TUV Sud
Global	Max Data Acquisition (Hz)	~ 60	100	100	TBC
Crush	Max Load (kN)	1,100	254	450	1,050
	Max Speed (mm/sec)	5	8	20	1
	Max Travel (cm)	76.2	30	122	530
	Max Test Size (cm)	150	38	122	1500
	Minimum Controllable Travel (mm)	2.5	1.5	TBC	~ 2
	Step Control	1-20	1-20	1-20	1 or 2
Overcharge	Max Current (I)	400	1,000	200	1,000
	Max Voltage (V)	600	900	600	1,000
	Max Power (kW)	20	250	20	250
Short Circuit	Minimum Resistance (mΩ)	2.9	4.7	1.0	TBC

**Table 28 Test Site Technical Capability Comparison**

## 9.2. Selected Testing Sites

Following of the test sites described in section 9.1, SNL was selected as able to perform all the project testing. Shown below (see Figure 27, Figure 28, Figure 29 and Figure 30) are various test equipment and setups used at SNL during the initial round of testing for the project in the fall of 2012. Following the start of testing, SNL experienced battery testing facilities and scheduling issues that let to their temporary suspension of any battery abuse testing. Before these test schedule issues arose at SNL, 18 string and module level tests were performed and their results aided the initial development of the project test procedure.



**Figure 27 SNL Crush Fixture**



**Figure 28 SNL Overcharge Fixtures**



**Figure 29 SNL Short Circuit Fixture**



**Figure 30 SNL Pack Test Site (Planned)**

In section 3.3.2, the evolution of the testing program scope was presented. It explains that after the initial selection of SNL as the testing source, the planned number of tests was expanded.

To accommodate the significant expansion of testing described and facilities/scheduling issues with SNL, MGA was sourced as a second test site in the spring of 2013. Due to ongoing test site

scheduling challenges with SNL, MGA became the principle test site for string and module testing as the project progressed in 2013 on into 2014. MGA generally performs pack level testing in its Burlington, WI site and smaller scale battery work at its Akron site. The string and module test scope for MGA led to all their work for this project being done in New York. Several images of MGA's New York test site and testing chambers are shown in Figure 31.

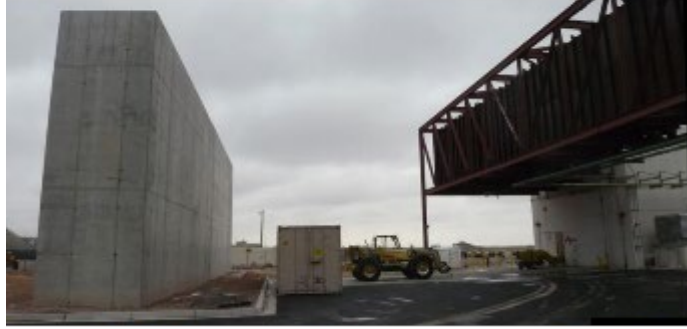


**Figure 31 MGA Research Test Site**

The project's approach to hardware progression (string then module then pack), allowed time for SNL to reconcile its facilities and scheduling issues with battery abuse testing. As a result, the project moved forward with smaller scale testing at MGA, while all pack testing for the program was performed at SNL as originally planned. Pictures of the SNL pack crush test site and fixture are shown in Figure 32 (note, yellow arrows in final picture are added to point to people in the scene to give a perspective of size).



**Pack Testing**



**Figure 32 SNL Pack Test Site (Actual)**

As was described in section 3.3.2, a second no-cost expansion of the test plan was proposed by the project team and approved by NHTSA in November 2013. This second test program expansion was to allow additional string and module testing by third test site. On the basis of previous cost estimates and a review of capabilities, South West Research Institute was sourced for this additional testing. Images of the battery testing chambers and fixtures at SwRI are shown in Figure 33.



**String & Module Testing**

**Figure 33 SwRI Test Site**



This combination of test sites provided an opportunity to evaluate the test procedures with several testing teams, gain insight from the execution of the tests on differing equipment, and compare collected data using differing lab equipment.

### 9.3. Testing Plan Overview

The progress of the testing towards the testing plan goal during the length of the project is described in Figure 34. Testing began in September of 2012 at SNL and continued for approximately two months until the availability issue described in the previous sections emerged. String and module testing began at MGA in June of 2013 and continued until the testing end in July 2014. SwRI was brought on for side by side testing from December 2013 to May 2014. SNL's pack testing activity concluded in its testing activity in April 2014.

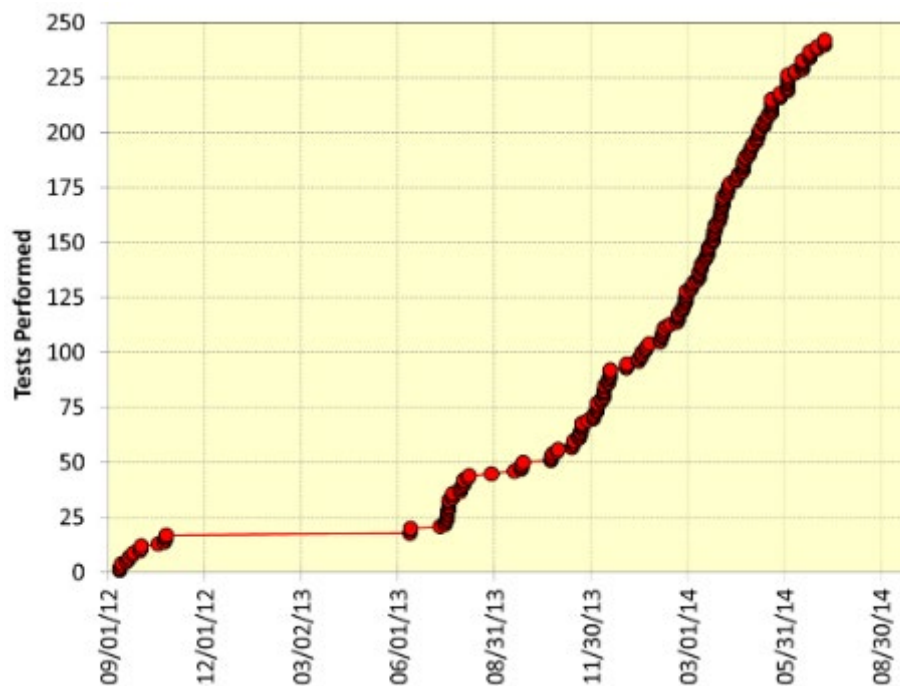


Figure 34 Cumulative Tests Performed

Testing was formally concluded on July 4, 2014, to align with the contract end date and reporting obligations. In the end, the project finished 245 of the possible 272 units, with the majority of the untested hardware items confined to the Type C modules.

### 9.4. Testing Summary

During the course of the test procedure development modifications were made to the evolving test procedure. As shown in Figure 34 and described in section 9.2, the initial 18 tests of the program were performed at SNL. Subsequent facility, scheduling and availability challenges at SNL prevented the restart of testing until approximately eight months later. During the course of this period, the initial test data was reviewed and analyzed to help refine the test protocols. In the end

a partial factorial design of experiments was implemented given hardware and test site capability limitations.

#### 9.4.1. Crush

A summary of the crush testing hardware and conditions (axes and steps) is shown in Table 29. Crush testing represented approximately one half of all tests performed. The relative hardware distribution by Type shown in Table 3 is seen in the crush test summaries of Table 29. Additionally, the increasing test unit quantities from pack to module to string arose from the overall test approach shown in Figure 5.

Axes	Crush Steps	Strings			Modules			Pack	
		A	B	C	A	B	C	A	C
X	1	11	3	2	2	1	0	0	0
	3	7	2	2	2	1	0	0	0
	20	4	3	2	3	2	0	2	0
Y	1	5	3	2	2	1	0	0	1
	3	4	2	2	2	1	0	0	0
	20	4	3	2	2	1	0	2	2
Z	1	8	3	2	4	1	0	0	1
	3	5	2	2	2	1	0	0	0
	20	4	3	2	3	1	0	2	2

Table 29 Crush Tests

#### 9.4.2. Overcharge

As was described in section 7.2, the overcharge procedure implementation by each of the test sites led to the reclassification of its conditions over time. Initially, the test conditions were patterned on the constant current, voltage and power modes found in vehicle chargers. The practical implementations of constant voltage and constant power protocols led to charge patterns that maxed out the test hardware's current rating before reaching the target compliance voltage and power loads. As a result, the test conditions described in Table 30 are organized by their resulting current of delivered charge. Overcharge testing presented approximately one third of all testing performed.

Pattern	Current (A)	Strings			Modules		
		A	B	C	A	B	C
Continuous	25	2	0	0	0	0	0
	32	7	3	2	4	3	0
	60	2	2	0	0	0	0
	75	2	0	1	2	2	0
	150	4	2	2	2	2	0
	200	1	0	0	0	0	0
	275	0	1	0	1	1	0
Start Stop	25	1	0	0	0	0	0
	60	5	2	0	2	0	0
	75	2	1	2	2	1	0
	150	3	1	2	2	1	0
	200	1	0	0	0	0	0
	275	2	0	0	0	0	0

Table 30 Overcharge Tests

### 9.4.3. Short Circuit

Short Circuit testing was distributed amongst three relative resistance ratios: hard (~10), medium (~30) and soft (~100). This testing accounted for approximately one sixth of all the testing performed during the program. The distribution of test conditions and hardware Types and levels is shown in Table 31.

Resistance	Strings			Modules		
	A	B	C	A	B	C
Hard	6	2	1	2	1	0
Medium	5	1	1	2	0	0
Soft	4	1	1	2	0	0

Table 31 Short Circuit Tests

## 10. Data Analysis

The test results were studied to determine where the most meaningful or predictive data might be found. The objective of this review was to prepare the analytical techniques that would be most useful while optimizing the time spent in data assessment. Work was performed to determine if complex mathematical approaches would lead to better outputs than output based on experienced engineering judgments.

To accomplish this in an organized fashion, a simple matrix of recorded response variables was constructed. From this simple matrix, an exploration of potentially valuable information derived from the primary data was performed. This expansive look led to the creation of more detailed matrices that were given the name “rubric” to provide a common definition of the tool under development. The rubric is explained more completely in the following section.

### 10.1. Test Variables Rubric

Across all three test types (crush, overcharge and short circuit), primary data collection is contained in the voltage, current and temperature signals. From these signals, the plan called for plotting to provide a graphic interpretation of each test, and to permit the identification of important events or predictors.

During the early stages of data analysis, it became clear that there were a large number of plots/graphs that could be produced when evaluating the data. The volume of data identified a need to methodically evaluate the value of these plots and track those that are useful. A rubric that contained many of the possible plots was developed. An example of an initial rubric for overcharge data variables was defined as follows (Table 32) with potentially useful plots identified as A through P:

Y-Axis	V	A	C				
	T	B	D				
	dmV/dt	E	G	I	O	P	
	dT/dt	F	H	J			
	Q	K	M				
	dQ/dt	L	N				
	t	SOC	Avg Skin T	dT/dt	V	Energy	dEnergy/dt
	X-axis						

Table 32 Candidate Chart Types for Overcharge Data Analysis

Although engineering judgment might permit acceptable identification of the plots that are most meaningful, it was determined that a more thorough analytical assessment might enhance the selection process.

The initial rubric was expanded by listing all of the measured variables for each of the three test types. The measured variables included voltage, current, temperature, displacement (crush only), force (crush only) and time. These variables were evaluated for common calculations that have additional physical meaning such as mechanical power, electrical power and state-of-charge and were added to the rubric.

Next the integrals and derivatives of the basic variables were evaluated. The integrals of the basic variables with respect to time or space were considered, whereas integration with respect to other basic variables was not considered due to a lack of physical meaning. The following integrals were thought to have some potential physical meaning.

- Crush:
  - $\int(\text{displacement}) d(\text{time})$
  - $\int(\text{force}) d(\text{time})$
  - $\int(\text{force}) d(\text{displacement})$
  - $\int(\text{temperature}) d(\text{time})$
  - $\int(\text{voltage}) d(\text{time})$
- Overcharge and Short Circuit:
  - $\int(\text{current}) d(\text{time})$
  - $\int(\text{Temperature}) d(\text{time})$
  - $\int(\text{Voltage}) d(\text{time})$
  - $\int(\text{Electrical Power}) d(\text{time})$

After evaluating the integral combinations, the derivatives were reviewed. The derivatives were more challenging to pre-filter without a thorough review, and thus all combinations of derivatives were added to the rubric, including reciprocals. This resulted in the addition of 30 derivative combinations for each test and a representative image of the overcharge rubric is shown in Table 33.

Table 33 Overcharge Rubric Table (Overall)

Once the rubric was fully developed each row and column was evaluated critically to determine which genuinely contributed to the test analysis. For example, all of the time variables were removed from the y-axis because the time variable is much more intuitive on the x-axis. This left a number of basic variable combinations that were of possible interest and the resultant overcharge variable rubric is shown in Table 34: In the table, gray cells represent uninteresting plots and white cells represent interesting plots.

Overcharge Variables	Current (i)	Electrical Power (calc) (Pe)	State of Charge (Calc) (SOC)	Temperature (T)	Time (t)	Voltage (V)
Current (i)	N/A	Since $P_e = V_i$ ; this plot shows voltage in an indirect manner. Better to use direct voltage measurement.	Not meaningful for CC test data available	Not meaningful for CC test data available		
Electrical Power (calc) (Pe)	Since $P_e = V_i$ ; this plot shows voltage in an indirect manner. Better to use direct voltage measurement.	N/A				Since $P_e = V_i$ ; this plot shows current in an indirect manner. Better to use direct current measurement.
State of Charge (Calc) (SOC)	Better to look at swapped axes; see cell \$J\$12	Better to look at swapped axes; see cell \$J\$13	N/A	Better to look at swapped axes; see cell \$J\$15		Better to look at swapped axes; see cell \$J\$17
Temperature (T)	Better to look at swapped axes; see cell \$K\$12	Better to look at swapped axes; see cell \$K\$13		N/A		Better to look at swapped axes; see cell \$K\$17
Time (t)	Better to look at swapped axes; see cell \$K\$12	Better to look at swapped axes; see cell \$K\$13	Better to look at swapped axes; see cell \$K\$14	Better to look at swapped axes; see cell \$K\$15	N/A	Better to look at swapped axes; see cell \$K\$17
Voltage (V)	Better to look at swapped axes; see cell \$L\$12	Since $P_e = V_i$ ; this plot shows current in an indirect manner. Better to use direct current measurement.				N/A

Table 34 Overcharge Rubric Table (Direct Variables)

The final step in the rubric process involved plotting the remaining basic variable combinations in a waterfall style plot to evaluate their utility. Some of the plots, such as voltage versus SOC shown in Figure 35, were useful while others were not. The plots that were not meaningful were removed from the rubric, as were derivatives and integrals of the same plot. Plots that provided meaningful data were visually evaluated for potentially interesting features such as minimums, maximums and inflection points.

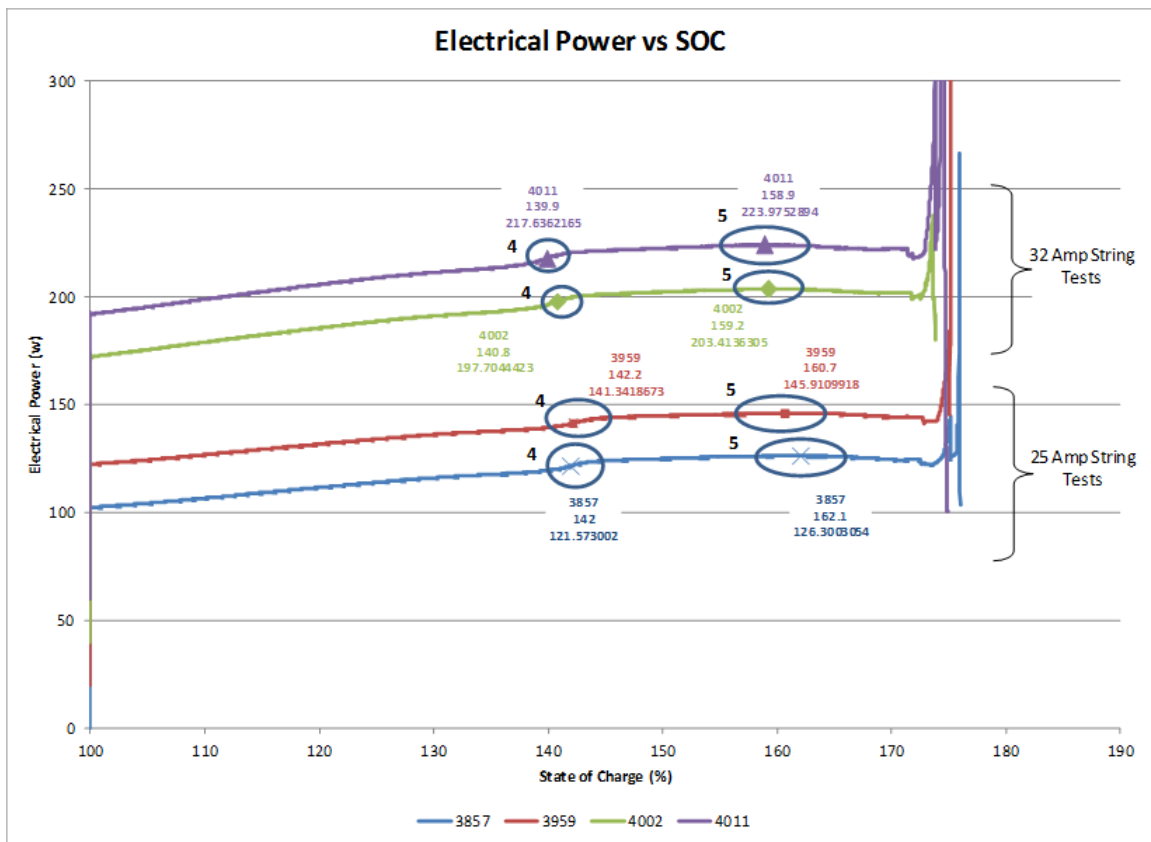
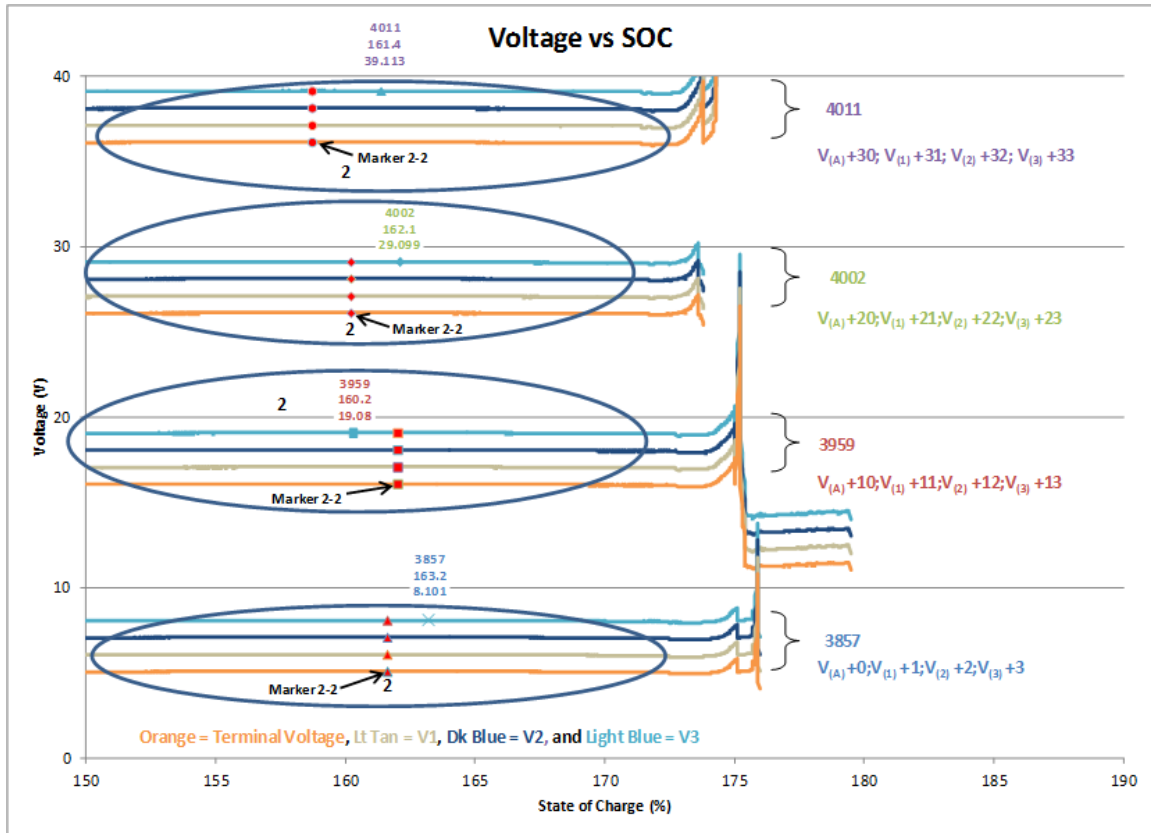


Figure 35 Rubric Voltages versus SOC

The interesting features from the rubric plots were compared one by one to markers identified during the initial plot generation process that was guided by engineering judgment (Figure 36). It

was determined that each rubric plot feature was already represented by a marker generated using engineering judgment or occurred after the defined end of test. This implied that the initial engineering judgment process of plot choice and marker identification is nearly as good as the formal rubric process and is much faster.



**Figure 36 Rubric Marker and Engineering Judgment Marker**

The results of this review produced a significantly reduced and far more manageable analysis plan, an example of which for Overcharge is shown in Table 35. The boxes shaded in green provide interesting features.

Overcharge Variables Matrix		Plot Key						
		Interesting Features Seen	Under consideration	Not recommended	Not Applicable			
Variable plotted on Y Axis		Variable plotted on X Axis						
		Current (i)	Electrical Power (calc) (Pe)	State of Charge (Calc) (SOC)	Temperature (T)	Time (t)	Voltage (V)	
		Current (i)	Not	Since Plot 12, the data on voltage is not recommended. Additionally, direct voltage measurement.	Not available for plotted data cells	Not available for plotted data cells		
		Electrical Power (calc) (Pe)	Since Plot 12, the data on voltage is not recommended. Additionally, direct voltage measurement.	Not			Since Plot 12, the data on current is not recommended. Additionally, direct current measurement.	
		State of Charge (Calc) (SOC)	Not available for plotted data cells	Not available for plotted data cells	Not	Not available for plotted data cells	Not available for plotted data cells	
		Temperature (T)	Not available for plotted data cells	Not available for plotted data cells		Not	Not available for plotted data cells	
		Time (t)	Not available for plotted data cells	Not available for plotted data cells	Not available for plotted data cells	Not available for plotted data cells	Not	Not available for plotted data cells
Voltage (V)	Not available for plotted data cells	Since Plot 12, the data on voltage is not recommended. Additionally, direct voltage measurement.				Not		
Overcharge Variables Matrix		Variable plotted on X Axis						
		Current (i)	Electrical Power (calc) (Pe)	State of Charge (Calc) (SOC)	Temperature (T)	Time (t)	Voltage (V)	

Table 35 Final Overcharge Variables Rubric

The development of the overcharge rubric was shown in this section as an example of the process followed to determine the relevant variables of interest that were analyzed. Following the development of the overcharge rubric, the validation of the engineering judgment approach was applied to the crush and short circuit analysis process. With the most meaningful plots defined, analysis of the test data began and interesting “markers” were defined for each type of test as explained in the following sections.

## 10.2. Crush Markers

The crush markers identified during the analysis along with their mathematical definitions are shown in Table 36. The crush data analysis focused on a combination of voltage, temperature, force and displacement trends and relationships.



Marker	Description	Mathematical Definition
1	Ram begins to move	Ram velocity $\geq 1$ mm/sec
2	Terminal voltage begins to roll off	1 <sup>st</sup> derivative, $dV/dt < -0.1$
3.a,b,c...	Inflection in terminal voltage	Minimum in 1 <sup>st</sup> derivative $\leq -0.4$ or $\geq 0.4$ and 2 <sup>nd</sup> derivative = 0
4.a,b,c...	Inflection in terminal voltage	Minimum in 1 <sup>st</sup> derivative $\leq -0.4$ or $\geq 0.4$ and 2 <sup>nd</sup> derivative = 0
5.a,b,c...	Terminal voltage < 0.5	Voltage < 0.5
6	Selected Bus Bar Temperature increases >5°C	Increase of temperature >5°C between points (50 °C/sec)
7	Selected Cell Temperature increases >5°C	Increase of temperature >5°C between points (50 °C/sec)
8	Maximum force	Maximum force
9	Average ram velocity from test start to end	Average ram velocity from test start to end
10	Force $\geq 0$ kN	Force $\geq 0$ kN
11	Force $\geq 1$ kN	Force $\geq 1$ kN
12	Force $\geq 2$ kN, start of test	Force $\geq 2$ kN, start of test
13	Cumulative Work from 2kN forward to end of test	
14	Ram stops moving, end of test	Ram velocity is <0.5 mm/sec
15	Terminal voltage $\geq 5$	Terminal voltage $\geq 5$
16.a,b,c...	Terminal voltage $\geq 1$ after it drops below 0.5V	Terminal voltage $\geq 1$ after it drops below 0.5V, limited to first 10 points

Table 36 Crush Markers

Markers were then identified on each analytical plot as shown in an example of force displacement plot for a continuous X-axis crush that was performed at SwRI (Figure 37).

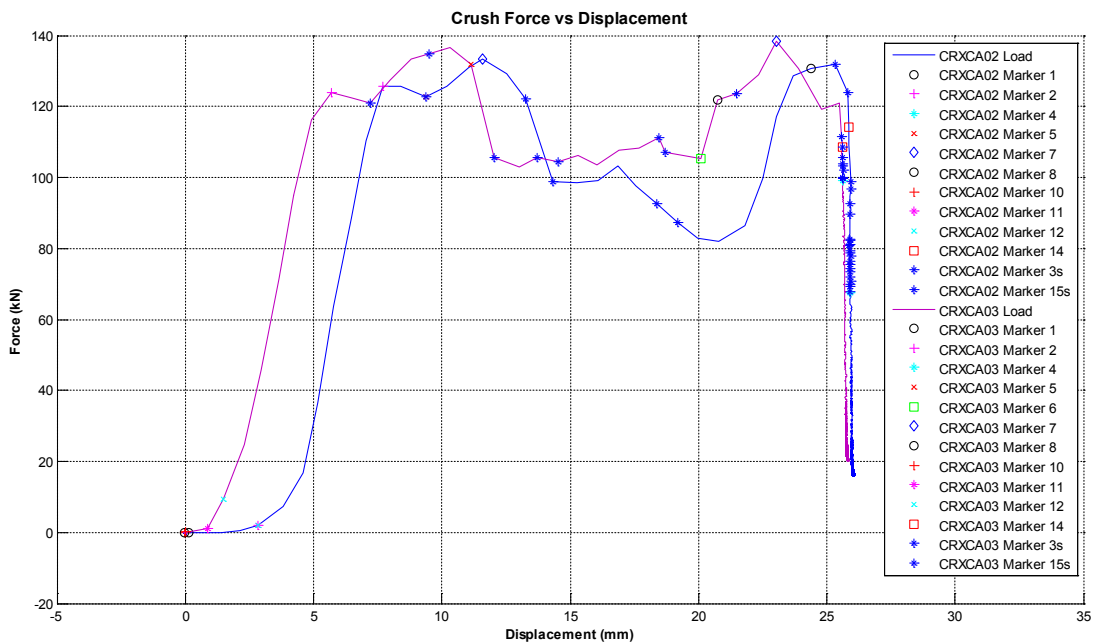


Figure 37 Example of Crush Markers Plot Overcharge Markers

### 10.3. Overcharge Markers

The overcharge markers developed and their respective plots are summarized in Table 37 and Figure 38. Voltage, current and temperature are the primary variables selected in the overcharge marker analysis.

Overcharge Markers		
Marker Label	Marker Definition	Plot Appearing
1-1	Start of Stage 1. Smoothed* dV/dt increase for 20 seconds (consecutive data points)*	dV/dt vs t
1-2	Smoothed* dV/dt local maxima around marker 1-1	dV/dt vs t
1-3	Local maximum around marker 1-1 of smoothed* maximum cell skin $d^2T/dt^2$	$d^2T/dt^2$ vs t
1-4	Local maximum around marker 1-1 of smoothed* maximum cell skin dT/dt	dT/dt vs t
2-1	Start of Stage 2. Smoothed* maximum cell skin dT/dt greater than marker 1-4 for 10 seconds (consecutive data points)	dT/dt vs t
2-2	5 consecutive dV/dt points below 0	dV/dt vs t
3-1	Start of Stage 3. >20 mV terminal voltage drop	term. V vs t
3-2	First local maximum of smoothed* maximum cell skin dT/dt after Marker 2-2	dT/dt vs t
3-3	Second local maximum of smoothed* maximum cell skin dT/dt after Marker 2-2	dT/dt vs t
3-4	First local minimum of smoothed* maximum cell skin dT/dt after Marker 2-2	dT/dt vs t
3-5	Second local minimum of smoothed* maximum cell skin dT/dt after Marker 2-2	dT/dt vs t
3-6	Smoothed* dV/dt increase for 10 seconds (consecutive data points) after Marker 3-1	dV/dt vs t
3-7	Smoothed* maximum cell skin dT/dt >0.2 for 10 seconds (consecutive data points) after Marker 3-1	dT/dt vs t

Table 37 Potential Overcharge Markers

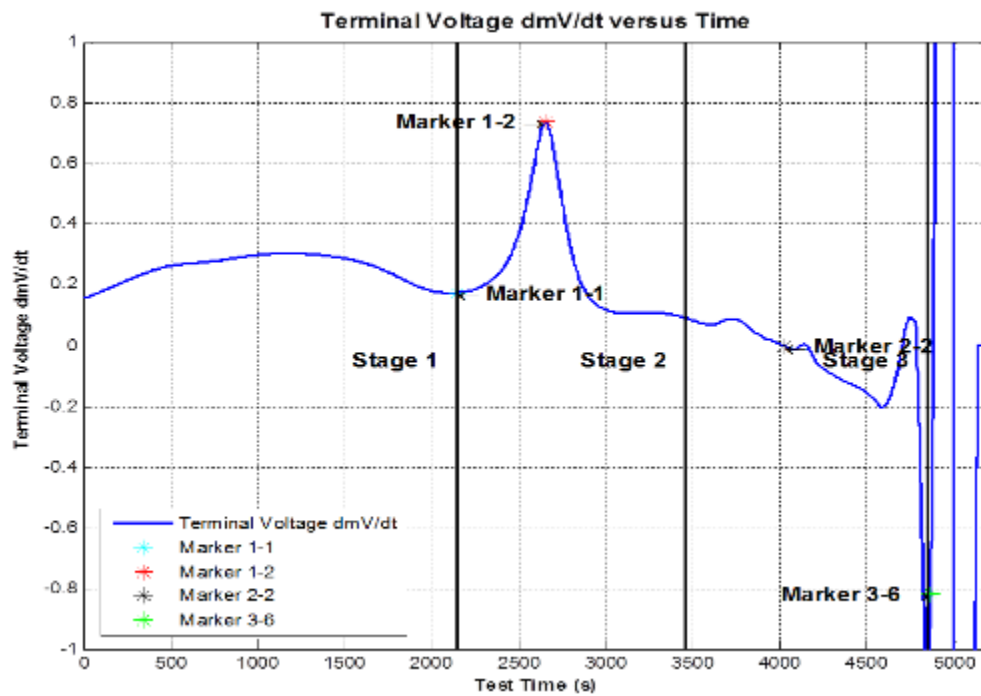


Figure 38 Example of Overcharge Marker Plot

## 10.4. Short Circuit Markers

The short circuit markers of greatest significance were those found to represent relative minimums, maximums and inflection points as shown in Table 38 and Figure 39. These markers primarily pertain to the relationship between current and voltage as the short progresses.

Marker	Description	Mathematical Definition
1	Voltage Min	On (a,b) $dV/dt=0$ and $d^2V/dt^2 >0$
2	Voltage Max	On (a,b) $dV/dt=0$ and $d^2V/dt^2 <0$
3	Voltage Inflection	$d^2V/dt^2=0$
4	Current Max	On (a,b) $dC/dt=0$ and $d^2V/dt^2 <0$
5	Current Inflection	$d^2C/dt^2=0$
6	Bus Bar Temperature Max	$dT/dt=0$ and $d^2T/dt^2 <0$
7	Bus Bar Inflection	$d^2T/dt^2=0$
8	Cell Temp Max	$dT/dt=0$ and $d^2T/dt^2 <0$
9	Cell Temp Inflection	$d^2T/dt^2=0$

Table 38 Short Circuit Markers

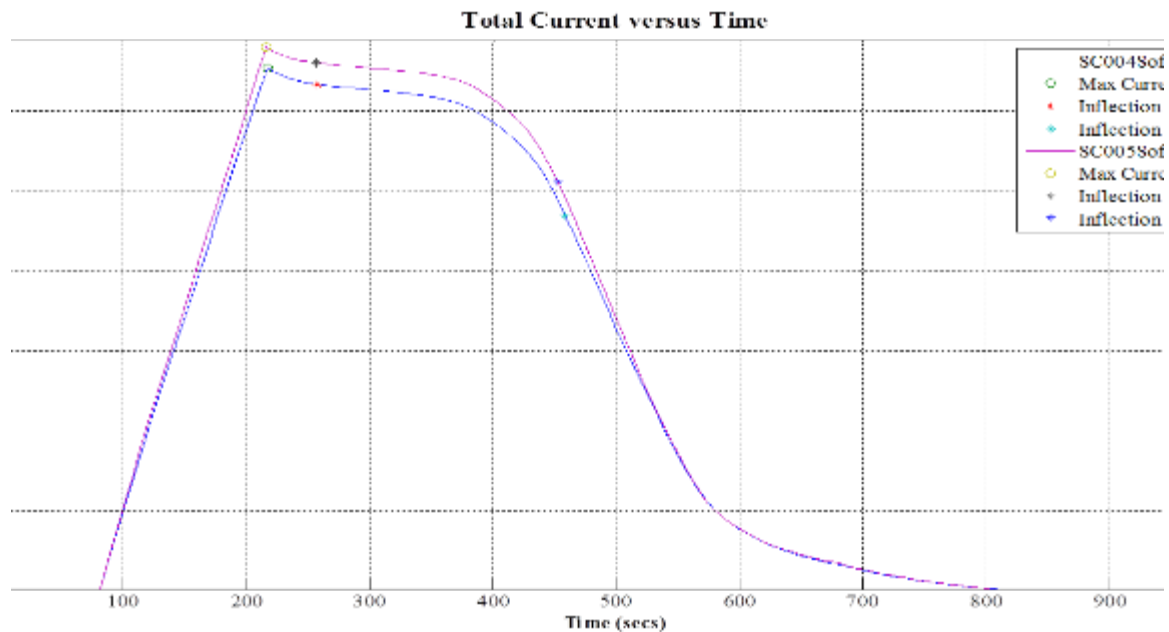


Figure 39 Example of Short Circuit Marker Plot

## 10.5. Crush Analysis

The crush experiments primarily focused on assessing the direction of impact (axes) and trying to discretize the displacement percent over time (number of steps). Given this focus, the overall responses of the RESS hardware to crush is divided in the same manner as shown in Figure 41, Figure 42 and Figure 43. These figures use boxplots to demonstrate the distribution of reactions for the individual testing condition populations. Additionally, this analysis focused on identifying the percent displacement at which EUCAR 3/4 (vent) and 5 (fire) events occurred (see Table 12).

### 10.5.1. Crush Summary

The crush specific analysis focused on the response of the hardware (EUCAR level) to the percent displacement of crush. A representative example of the force/displacement data reviewed is shown in Figure 40 for a Type A String, X-Axis 20-step crush.

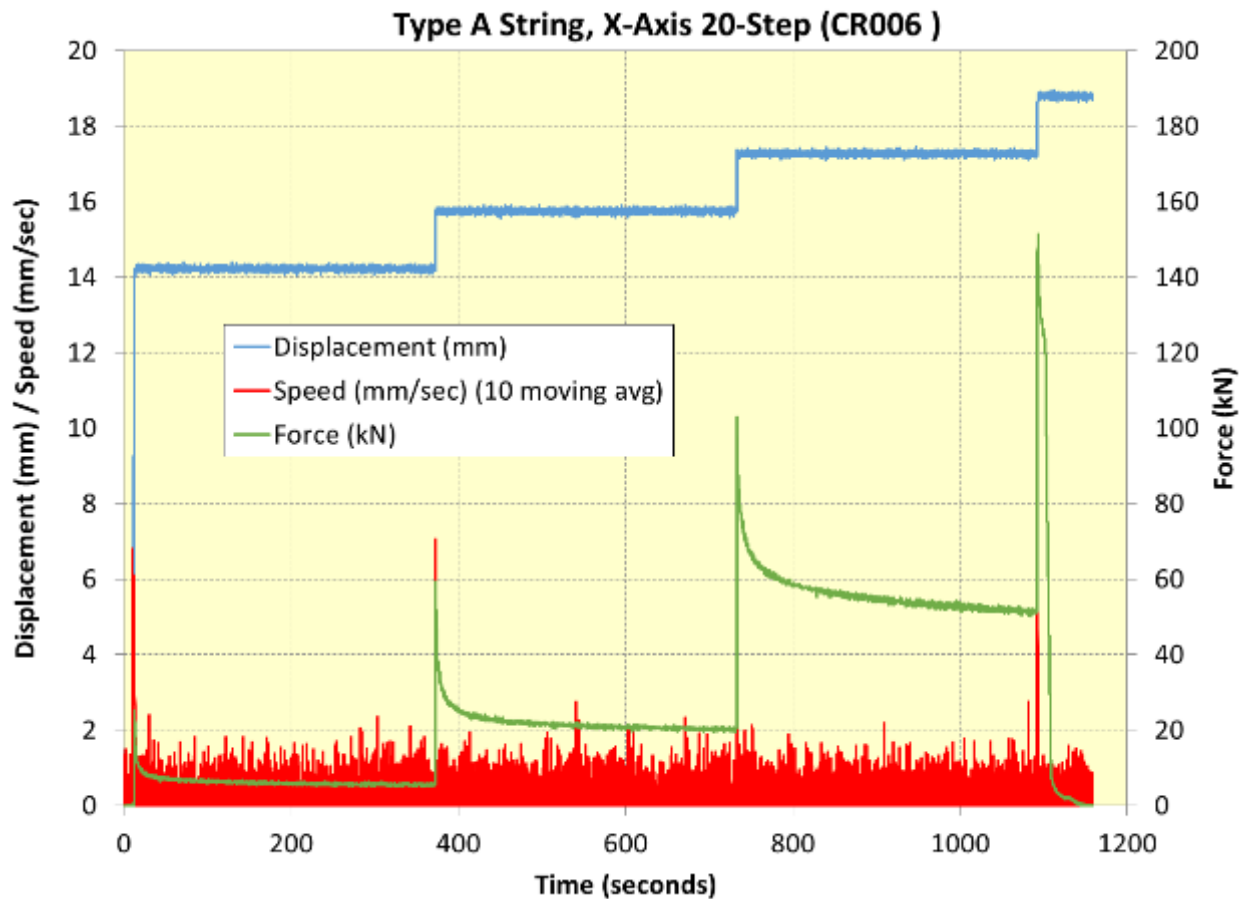


Figure 40 Force/Displacement Data for Type A String, X-Axis 20-Step (CR006)

A review of all the x-axis crushes yielded 32 complete data sets for review, the results of which are summarized in Figure 41. The x-axis data show a decrease of response variability as the crush motion is discretized from one motion to 5 percent percent displacement increments for both the EUCAR 3/4 and 5 results.

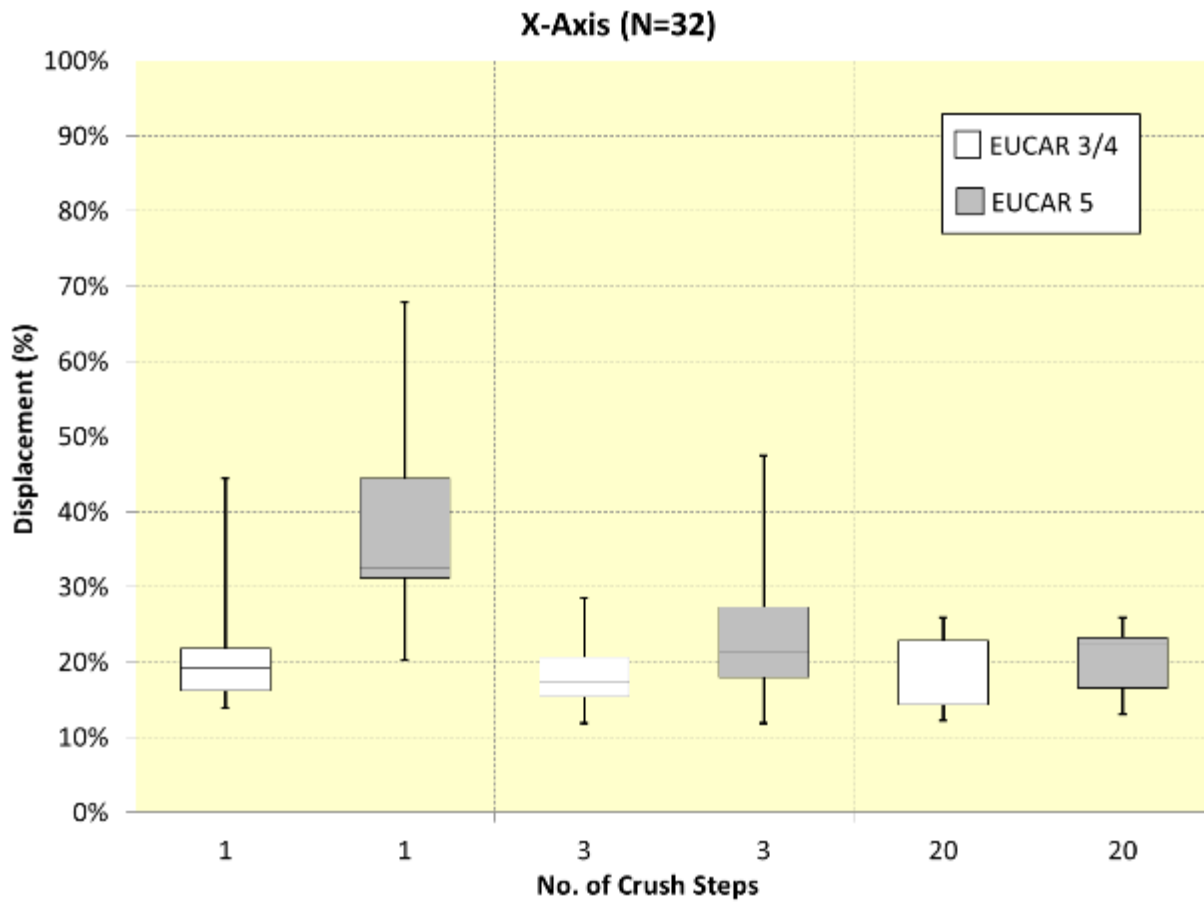


Figure 41 X-Axis Crush Analysis

The y-axis crush data of 34 tests shows a more homogenous distribution of the response displacement compared to the x-axis as is shown by the boxplot distribution in Figure 42. Overall the minimum displacements to trigger EUCAR 3/4 or 5 events appear similar (within <5%) to the x-axis condition with the exception of the 3-step EUCAR 5 events.

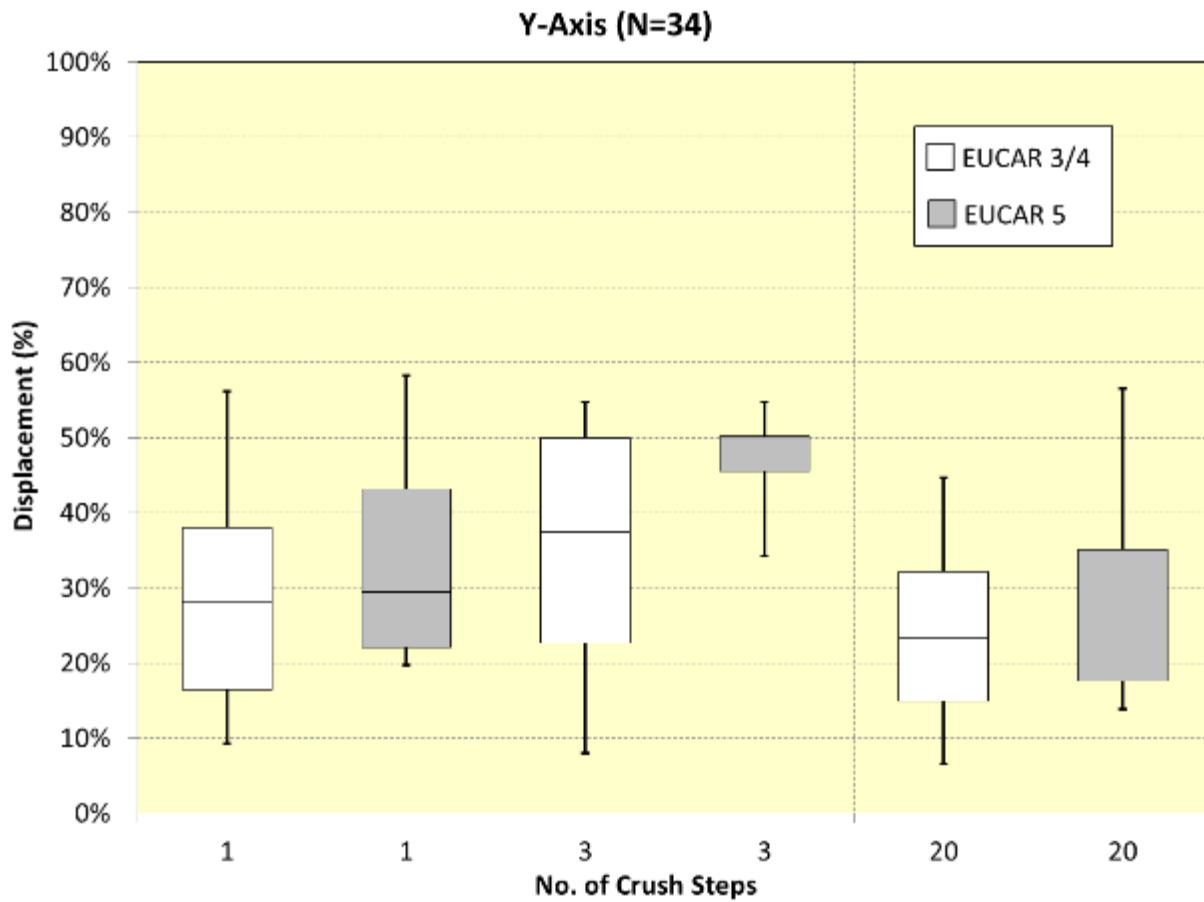


Figure 42 Y-Axis Crush Analysis

The z-axis test data of 39 tests (Figure 43) shows noticeably larger minimum displacements for all EUCAR 3/4 and 5 events for 1, 3 and 20 step testing when compared to both the x-axis (Figure 41) and y-axis (Figure 42) data.

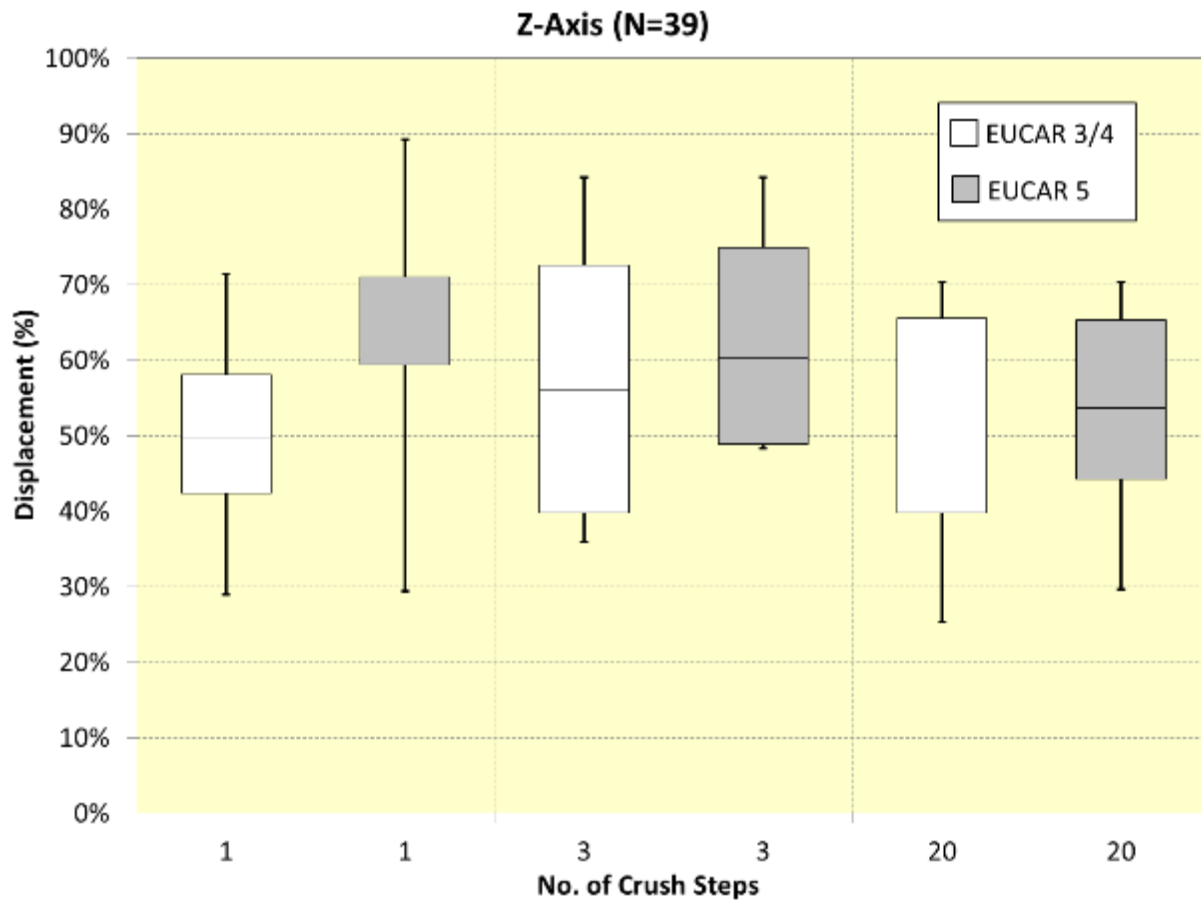


Figure 43 Z-Axis Crush Analysis

A comprehensive review of all three axes and the two bookends of time (1 and 20 step) conditions are shown in Figure 44. This figure shows the displacement (%) of EUCAR 5 events for the six conditions just described. The values labeled in green are where the first instance of a EUCAR 5 event was observed for all tests. Likewise, the numbers in red denote the displacement of when the last test article displayed a EUCAR 5. The displacement range in between the green and red values is labeled yellow to denote that it is a region of possible EUCAR depending on the test hardware and iteration. A comparison of the 1 and 20 step values shows a gradual decrease in the displacement (%) achievable prior to the initial EUCAR 5 event for the x and y axes. The initial z-axis displacement is mostly unchanged with time; however, its final point of occurrence (i.e., red value) does decrease as the crush event is longer and more discretized.

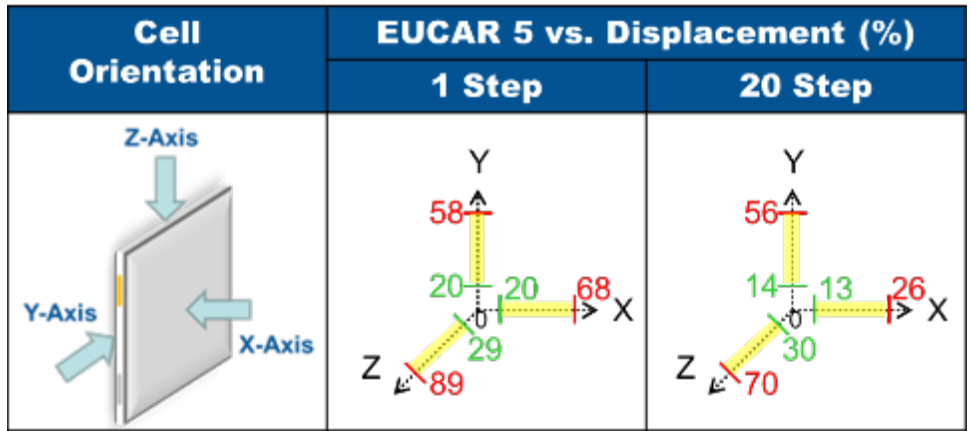


Figure 44 Crush Analysis Summary

### 10.5.2. X-Axis

In this section, plots and images of x-axis crush testing is described. A comparison of the three hardware types (A, B and C) is shown below. Each type has had a linear regression trend line added to visualize the impact of crush steps on displacement percentage of a EUCAR 5 event.

At the string level, it is generally seen that increasing the number of steps has either a modest decrease (Type A) or almost no impact (Type B and C) on the displacement percentage of a EUCAR 5 result. Broadly, the spread of the data decreases as the number of steps increases, with the 20 step results having a rather narrow range.

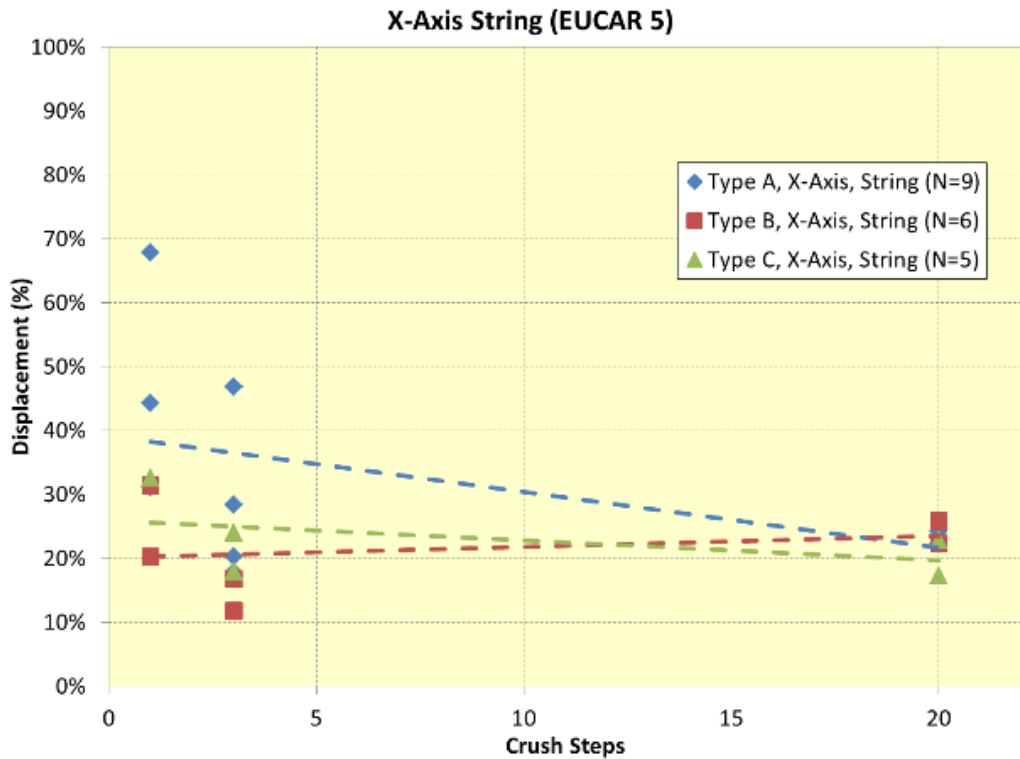


Figure 45 X-Axis String (EUCAR 5)





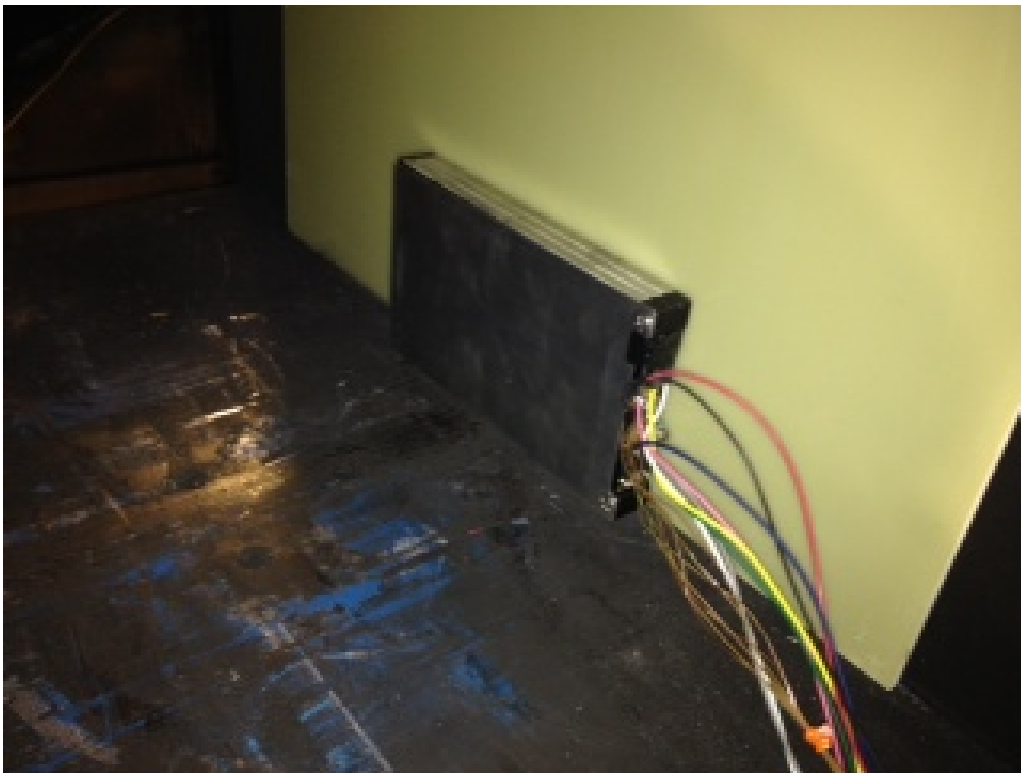
Figure 46 X-Axis Continuous String Type A Pre-Test Fixture (CRXCA03)



Figure 47 X-Axis Continuous String Type A Post-Test Fixture (CRXCA03)



**Figure 48 X-Axis Continuous String Type A Post-Test Hardware (CRXCA03)**



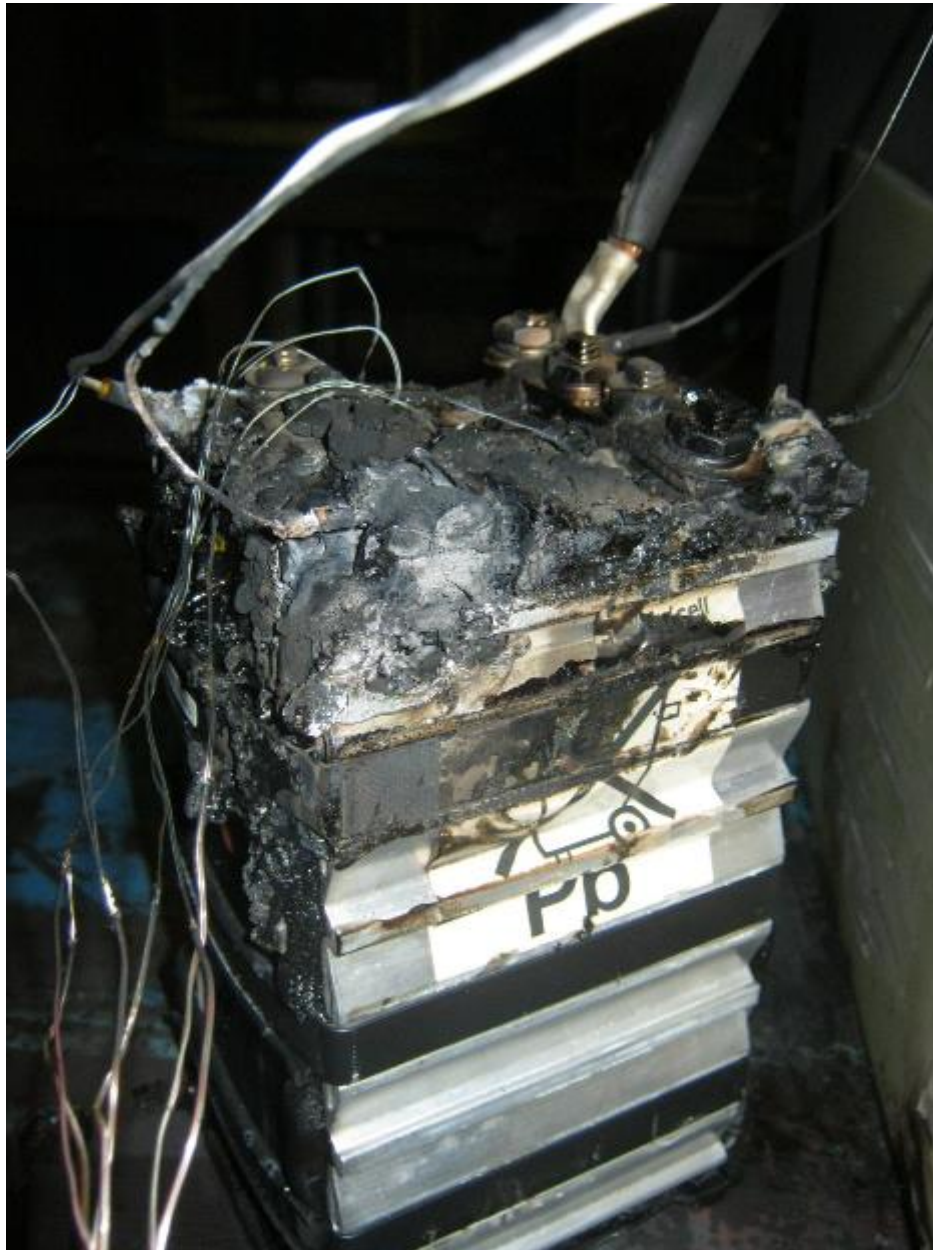
**Figure 49 X-Axis Continuous String Type B Pre-Test Fixture (CR015)**



**Figure 50 X-Axis Continuous String Type B Post-Test Fixture (CR015)**

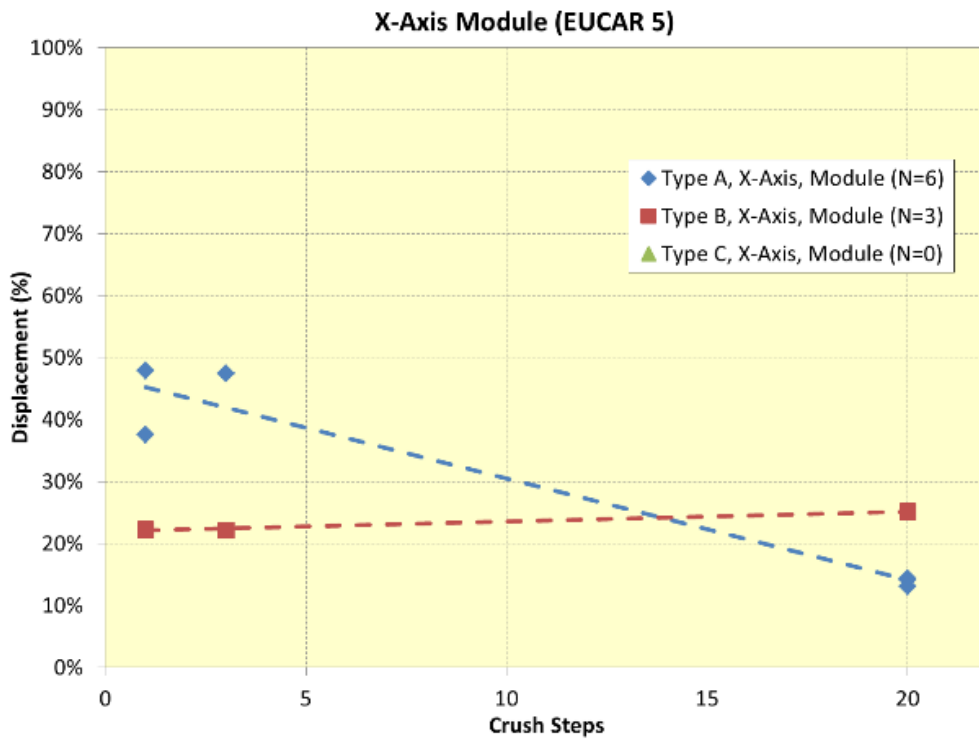


**Figure 51 X-Axis Continuous String Type C Pre-Test Fixture (CR042)**



**Figure 52 X-Axis Continuous String Type C Post-Test Hardware (CR042)**

A review the module data shows similar trends to the string results. As a function of steps or time to complete the crush, the results either decrease modestly (Type A) or stay relatively flat (Type B). Additionally the spread of the data generally decreases with step number, although to a lesser extent than in the strings. A crush to approximately 15 percent displacement was required by this condition before the initial EUCAR 5 results were triggered.



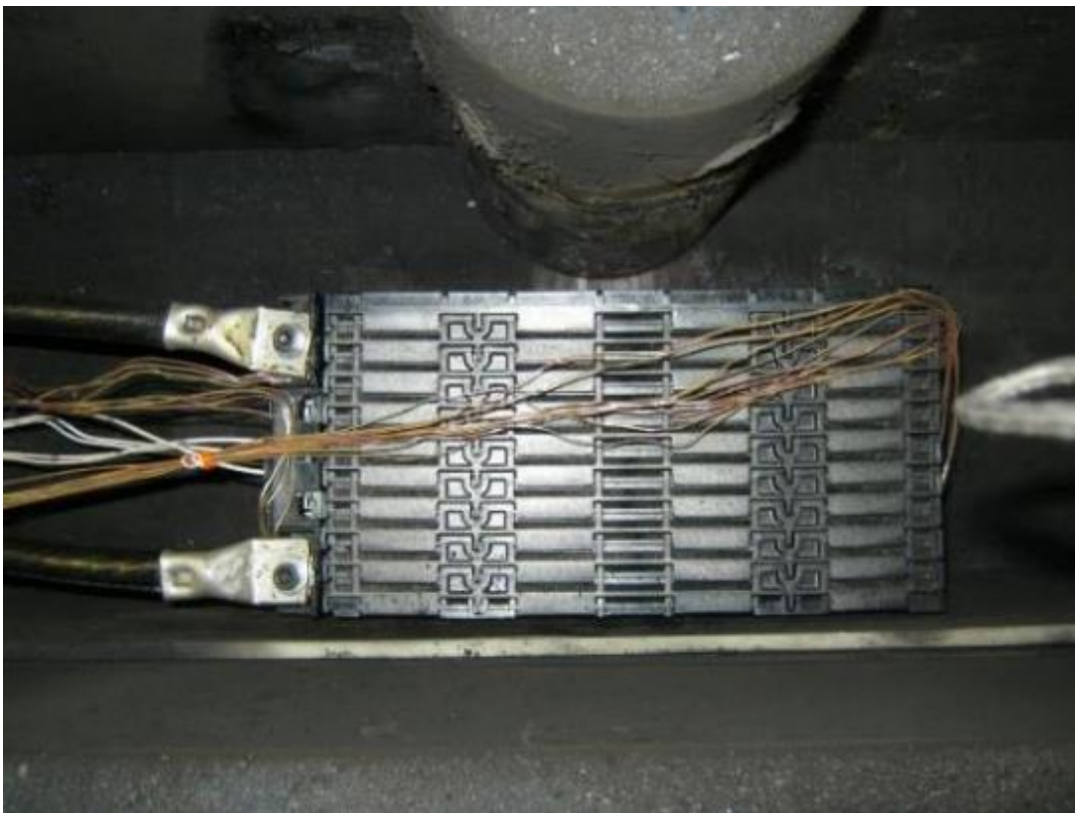
**Figure 53 X-Axis Module (EUCAR 5)**



**Figure 54 X-Axis Continuous Type A Module Pre-Test (CR057)**



**Figure 55 X-Axis Continuous Type A Module Post-Test (CR057)**



**Figure 56 X-Axis 20-Step Type A Module Pre-Test Fixture (CR060)**



**Figure 57 X-Axis 20-Step Type A Module Post-Fixture (CR060)**

### 10.5.3. Y-Axis

This section reviews the Y-Axis crush condition results using a similar approach to that above.

The string results for the Type A and B are very similar in terms of spread, relationship with step number and the linear regression center values. For the type C condition, although 7 examples of strings were tested, only one is plotted. Testing the Type C string in the Y-axis revealed difficulties in fully engaging the string hardware, as is shown in the following pictures. Although these units did not reach a EUCAR 5, based on the preponderance of data (using other axes and pack results) it is predicted that if the cells had been fully engaged the results would have been in line with the other data.

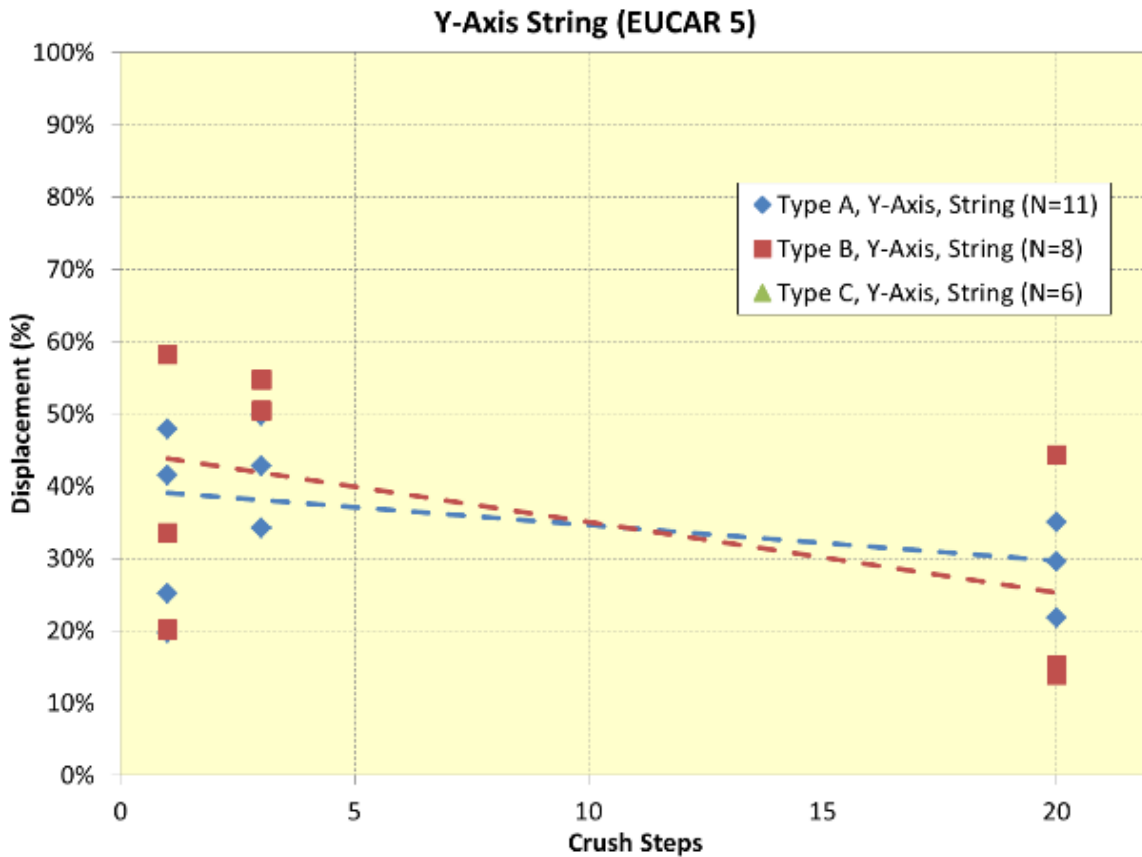


Figure 58 Y-Axis String (EUCAR 5)





**Figure 59 Y- Axis Continuous String Type A Pre-Test Fixture (CR012)**



**Figure 60 Y-Axis Continuous String Type B Post-Test Fixture (CR012)**



**Figure 61 Y-Axis Continuous String Type B Pre-Test Fixture (CR021)**



**Figure 62 Y-Axis Continuous String Type B Post-Test Fixture (CR021)**



**Figure 63 Y-Axis Continuous String Type C Pre-Test Fixture (CR037)**



**Figure 64 Y-Axis Continuous String Type C Post-Test Fixture (CR037)**

Regarding the Y-Axis module data, the test results analysis involved several Type A and one Type B unit. The trends seen at the string level (modest decrease in displacement percentage of EUCAR 5 as a function of step time) are also seen here. A review of the data shows that EUCAR 5 events only occurred at greater than 30 percent displacement for this condition.

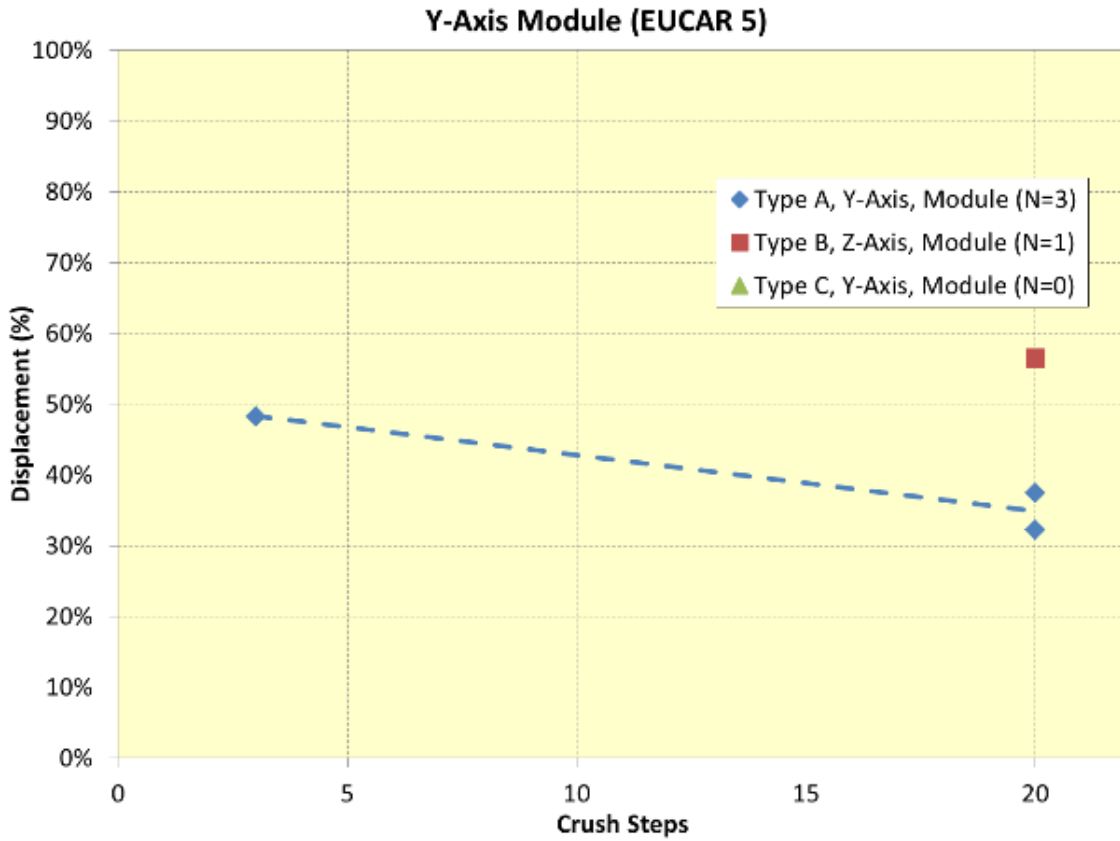
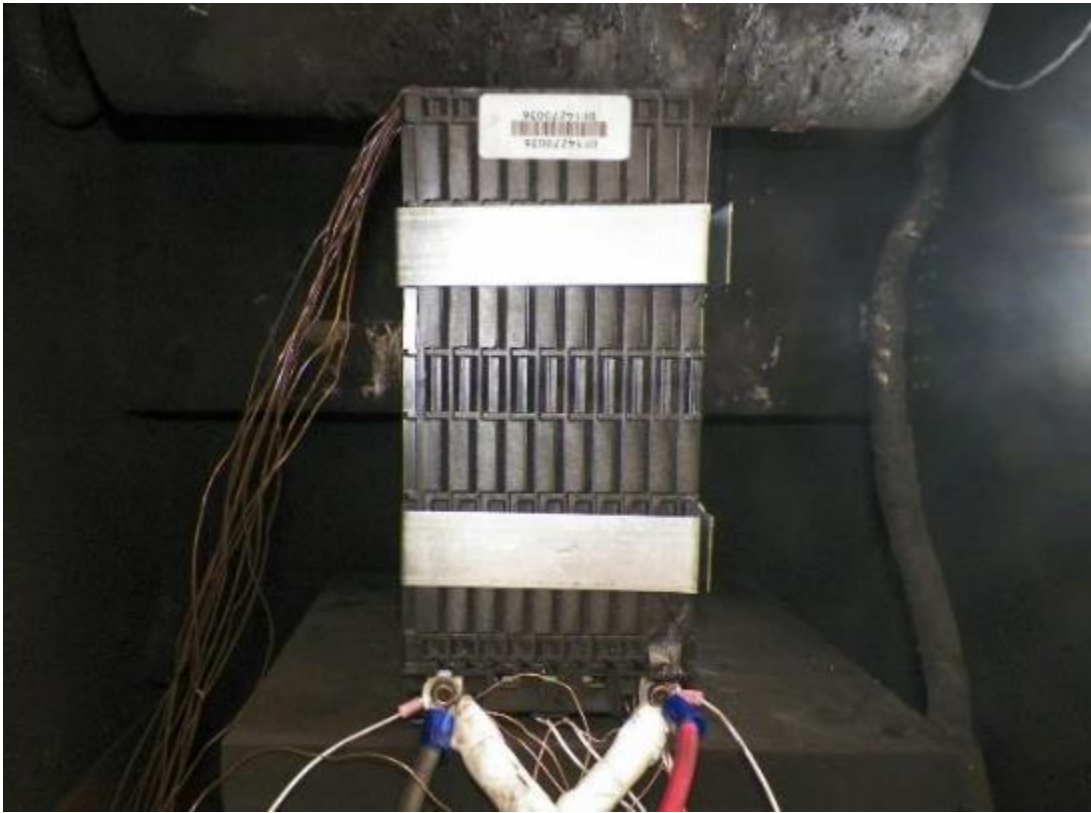


Figure 65 Y-Axis Module (EUCAR 5)



**Figure 66 Y-Axis 20-Step Module Type A Pre-Test Fixture (CRY20SAM01)**



**Figure 67 Y-Axis 20-Step Module Type A Post-Test Fixture (CRY20SAM01)**



**Figure 68 Y-Axis 20 Step Module Type B Pre-Test Fixture (CRY20SMB01)**



**Figure 69 Y-Axis 20 Step Module Type B Post-Test Fixture (CRY20SMB01)**

#### 10.5.4. Z-Axis

The Z-Axis crush results are analyzed in this section. As can be generally seen, compared to the X and Y-Axis, crushing in the Z-Axis progressed to larger displacement level before triggering a EUCAR 5 response.

The Z-Axis string results shown a similar impact of crush steps as the other axes, either a modest decrease (Type C) or no impact (Type A and B). No hardware experienced a EUCAR 5 prior to reaching 40 percent displacement.

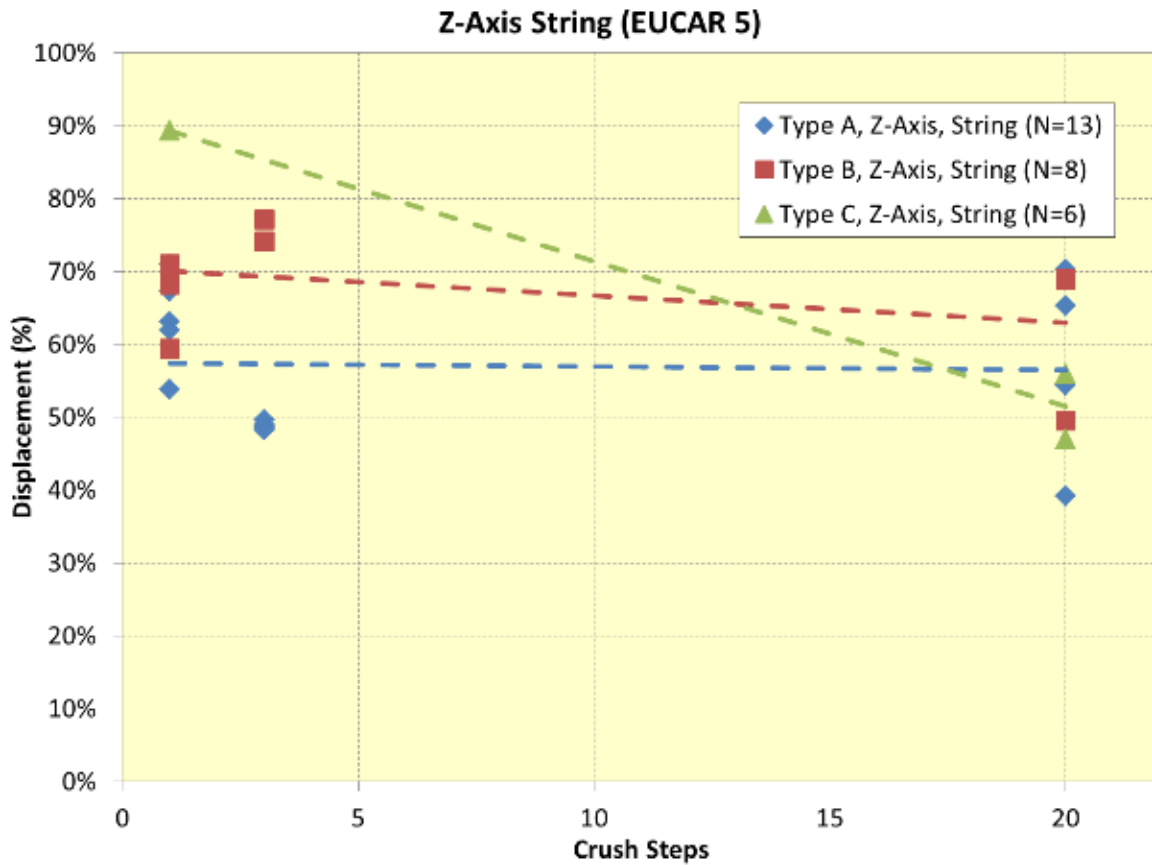


Figure 70 Z-Axis String (EUCAR 5)



**Figure 71 Z-Axis Continuous String Type A Pre-Test Fixture (CR065)**



**Figure 72 Z-Axis Continuous String Type A Post-Test Fixture (CR065)**





**Figure 73 Z-Axis Continuous String Type B Pre-Test Fixture (CR027)**



**Figure 74 Z-Axis Continuous String Type B Post-Test Fixture (CR027)**



**Figure 75 Z-Axis Continuous String Type C Pre-Test Fixture (CR033)**



**Figure 76 Z-Axis Continuous String Type C Post-Test Fixture (CR033)**

Z-Axis module testing reinforced the trend lines seen in the string data. Additionally, no EUCAR 5 event occurred until displacement percentage values greater than 45 percent were reached.

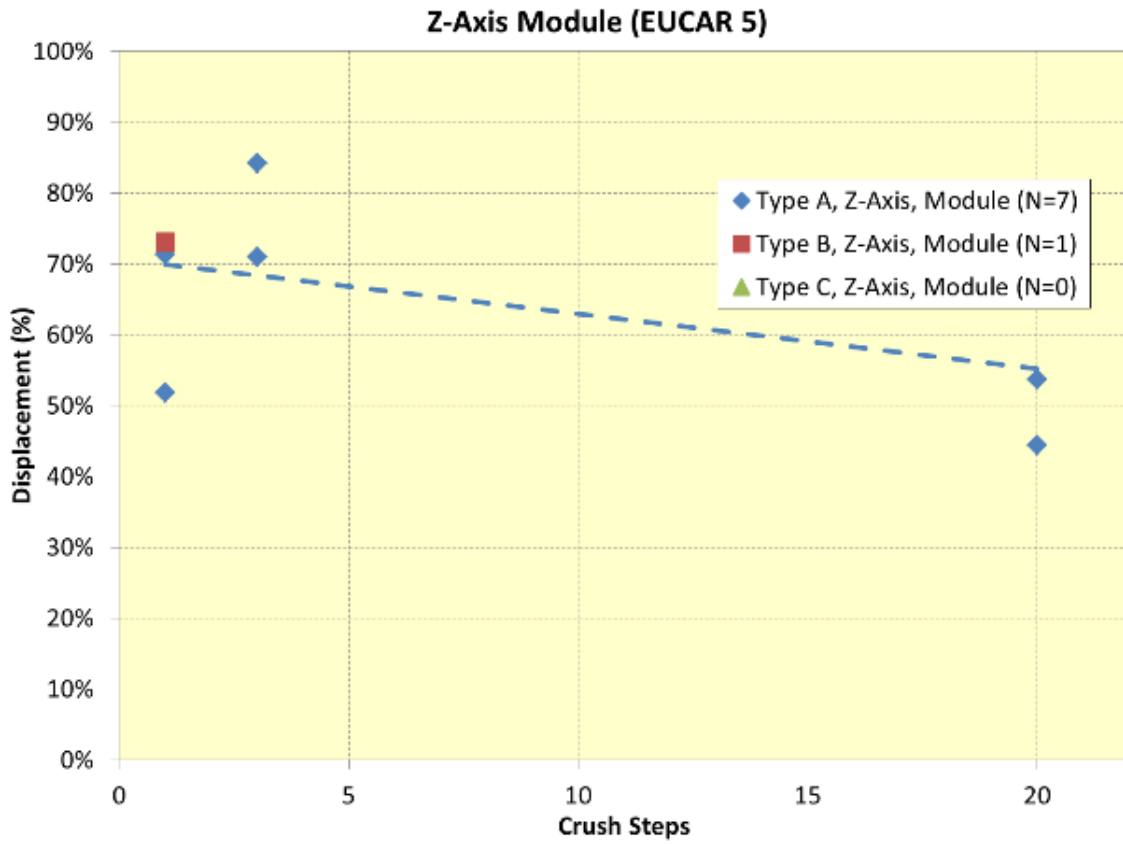


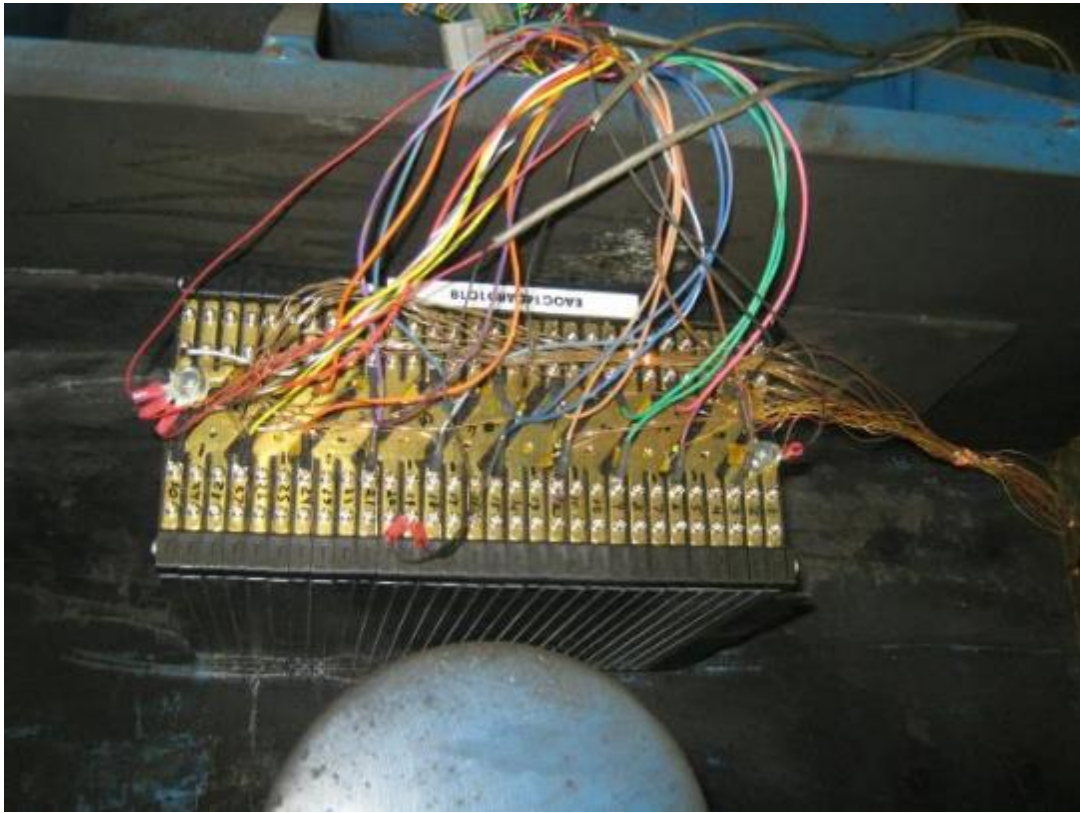
Figure 77 Z-Axis Module (EUCAR 5)



**Figure 78 Z-Axis Continuous Module Type A Pre-Test Fixture (CR062)**



**Figure 79 Z-Axis Continuous Module Type A Post-Test Fixture (CR062)**



**Figure 80 Z-Axis Continuous Module Type B Pre-Test Fixture (CR056)**



**Figure 81 Z-Axis Continuous Module Type B Post-Test Fixture (CR056)**

### 10.5.5. Type A

This section (and the subsequent 2 sections) compares the test results while controlling for the cell Type. By fixing the cell, the impact of cell construction and chemistry is controlled and the impact of hardware size can be viewed.

For the Type A X-Axis results, the string, module and pack results are compared below. As can be seen the linear regression trend lines of the string and module data are very similar. The results spread for strings and modules appear similar, decreasing as the number of steps increases. The Pack results at the 20-step interval are both in between the string and module results, indicating a consistency of performance in the Type A X-Axis.

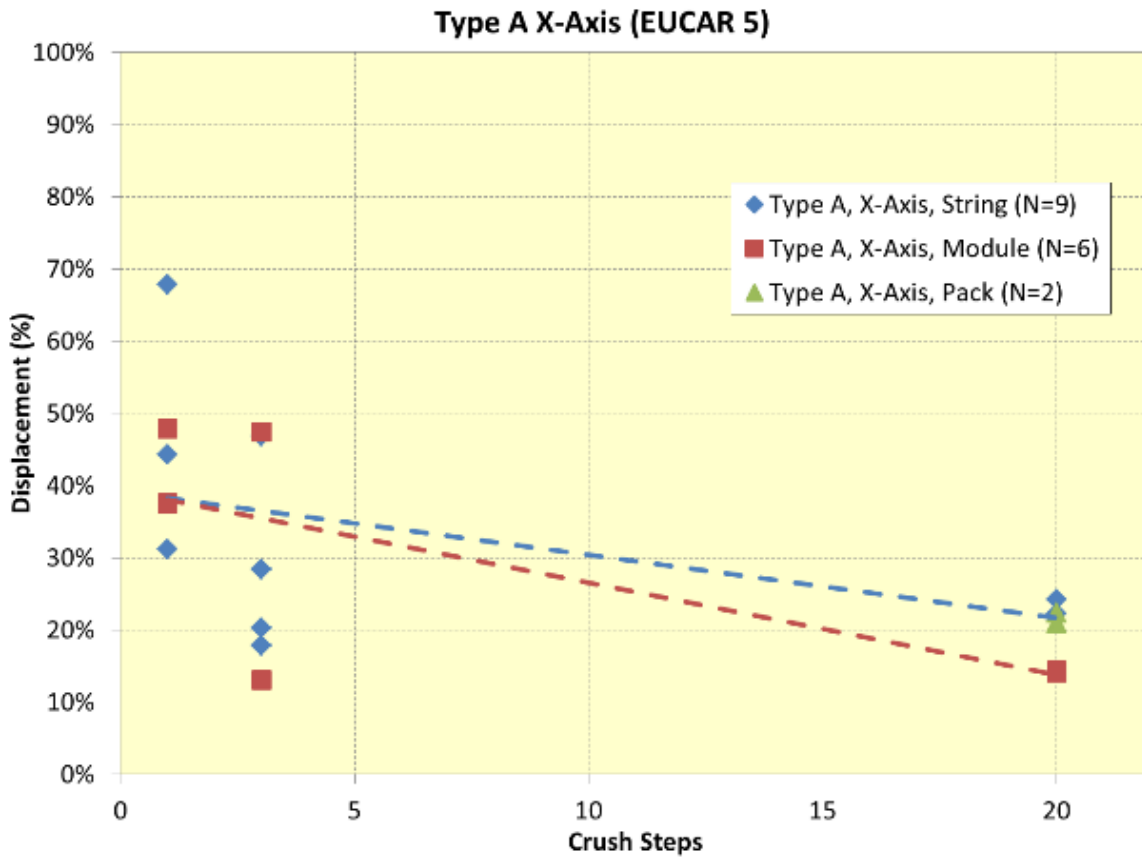


Figure 82 Type A X-Axis (EUCAR 5)



**Figure 83 X-Axis 20-Step Pack Type A Pre-Test Fixture (5)**



**Figure 84 X-Axis 20-Step Pack Type A Post-Test Fixture (5)**

A review of the Type A Y-Axis is also able to consider string, module and pack results. This population does not see the spread decrease with increasing crush steps, but does show pack results similar to the string/module data.

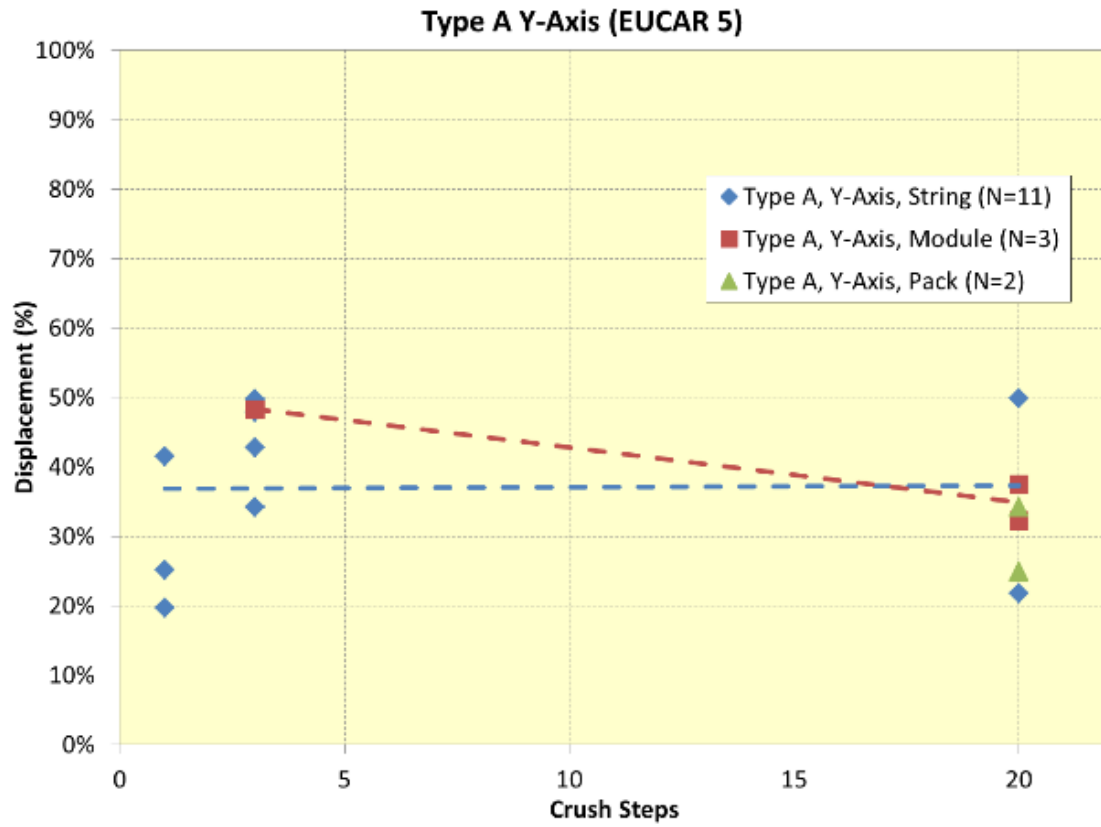
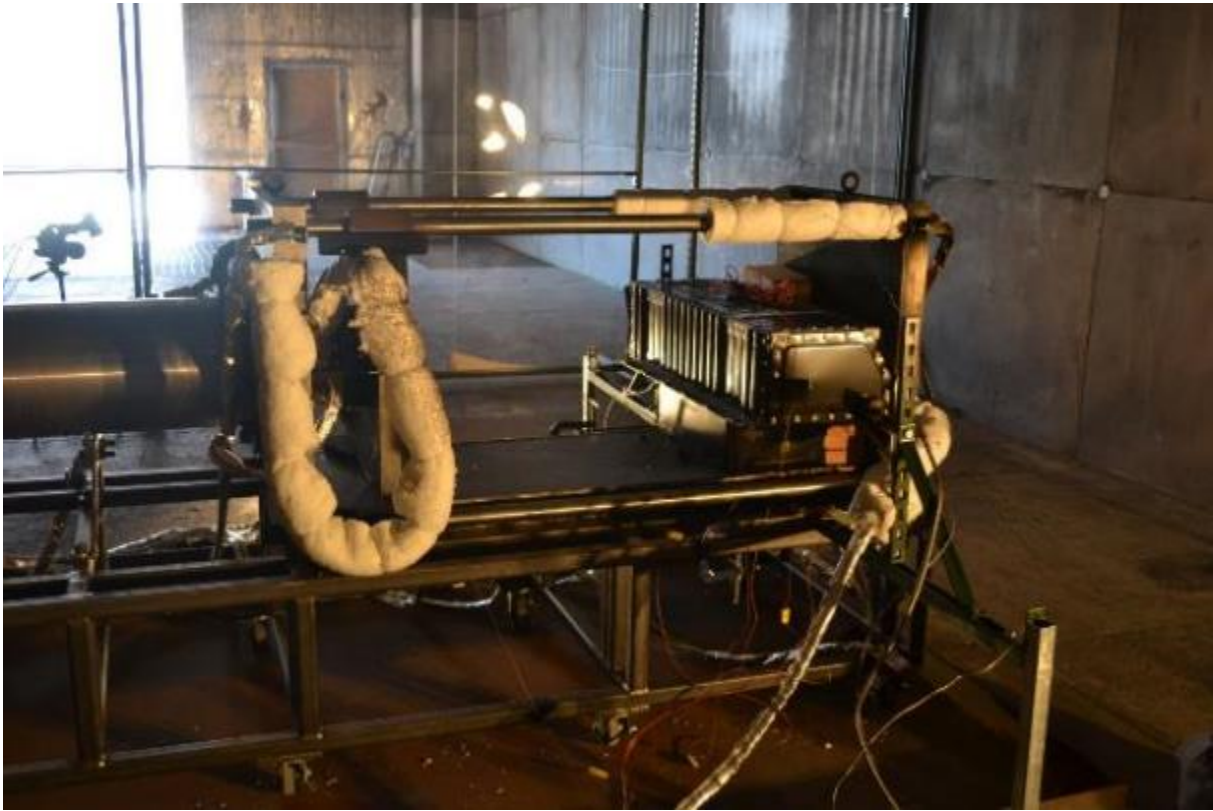


Figure 85 Type A Y-Axis (EUCAR 5)





**Figure 86 Y-Axis 20-Step Pack Type A Pre-Test Fixture (6)**



**Figure 87 Y-Axis 20-Step Pack Type A Post-Test Fixture (6)**

Comparing the Type A Z-Axis results, previously seen trends are reinforced. For example, the Z-Axis for all hardware types and within the Type A levels required the highest levels of displacements to trigger EUCAR 5 responses. Additionally, the impact of crush steps on displacement was either was modest as previously seen.

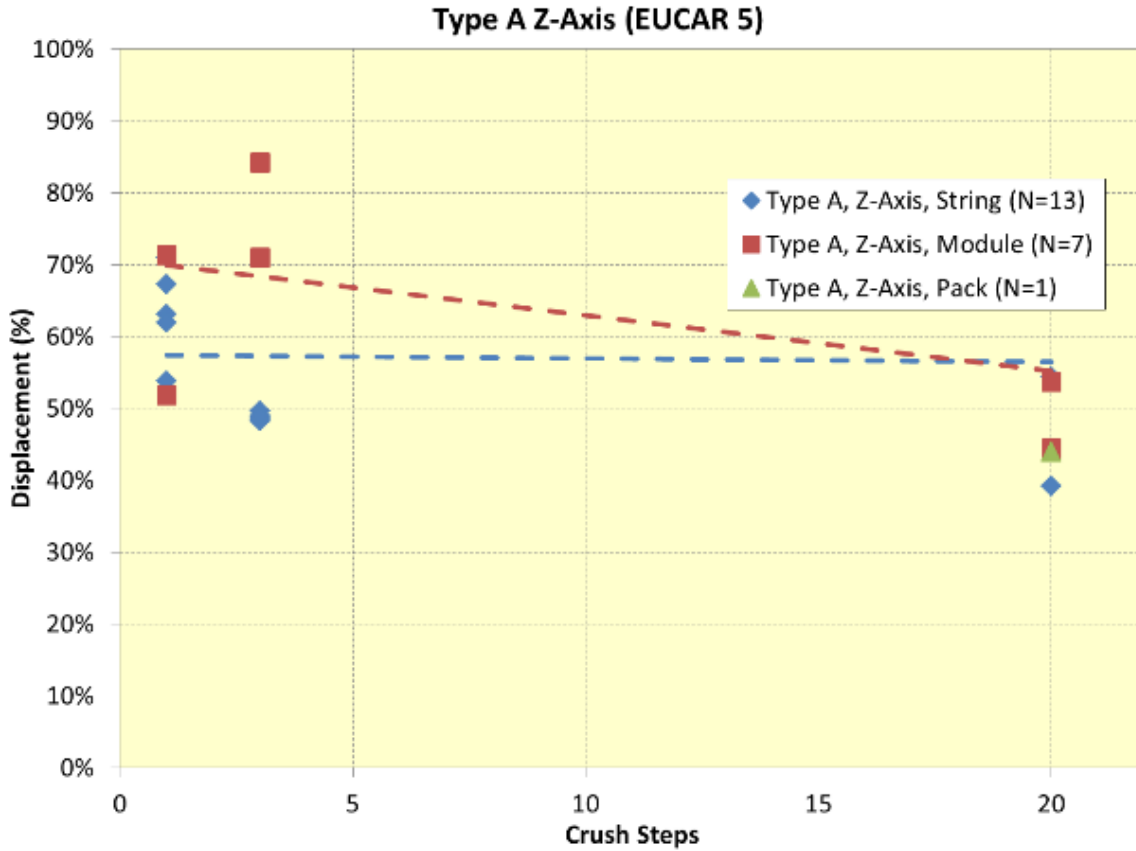
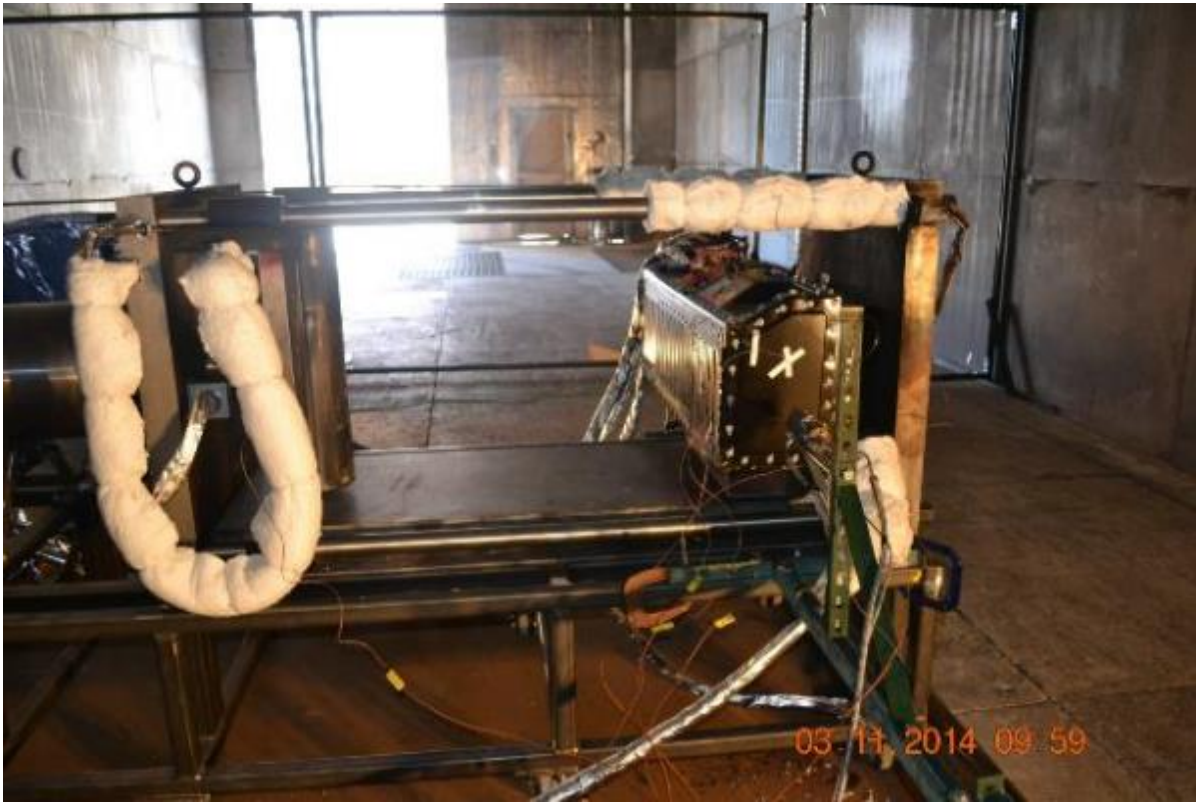


Figure 88 Type A Z-Axis (EUCAR 5)



**Figure 89 Z-Axis 20-Step Pack Type A Pre-Test Fixture (3)**



**Figure 90 Z-Axis 20-Step Pack Type A Post-Test Fixture (3)**

### 10.5.6. Type B

Similar to the Type A hardware review of section 9.5.6, by comparing the strings and modules built from Type B hardware, the impact of cells can be controlled.

The Type B X-Axis results show a relatively small spread of data at all conditions (1 versus 3 versus 20 step and amongst levels). The module configuration behaved either similar to the strings (1 step) or required ~5 percent more displacement to trigger a EUCAR 5 result.

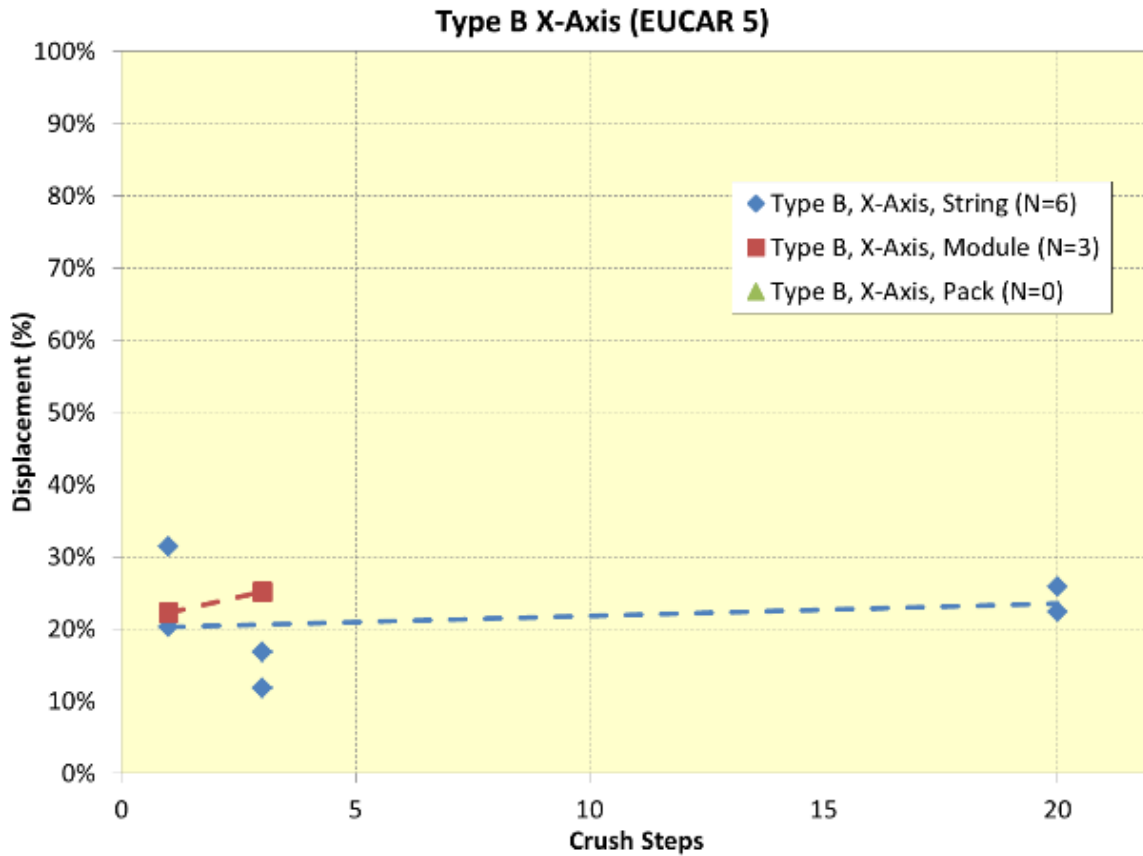


Figure 91 Type B X-Axis (EUCAR 5)



**Figure 92 X-Axis 3-Step String Type B Pre-Test Fixture (CR017)**



**Figure 93 X-Axis 3-Step String Type B Post-Test Hardware (CR017)**

The Type B Y-Axis data shows a relatively large spread of data. The likely root cause of the spread is challenge in keep these units fully engaged in the axis of crush, as was seen in the Type C results.

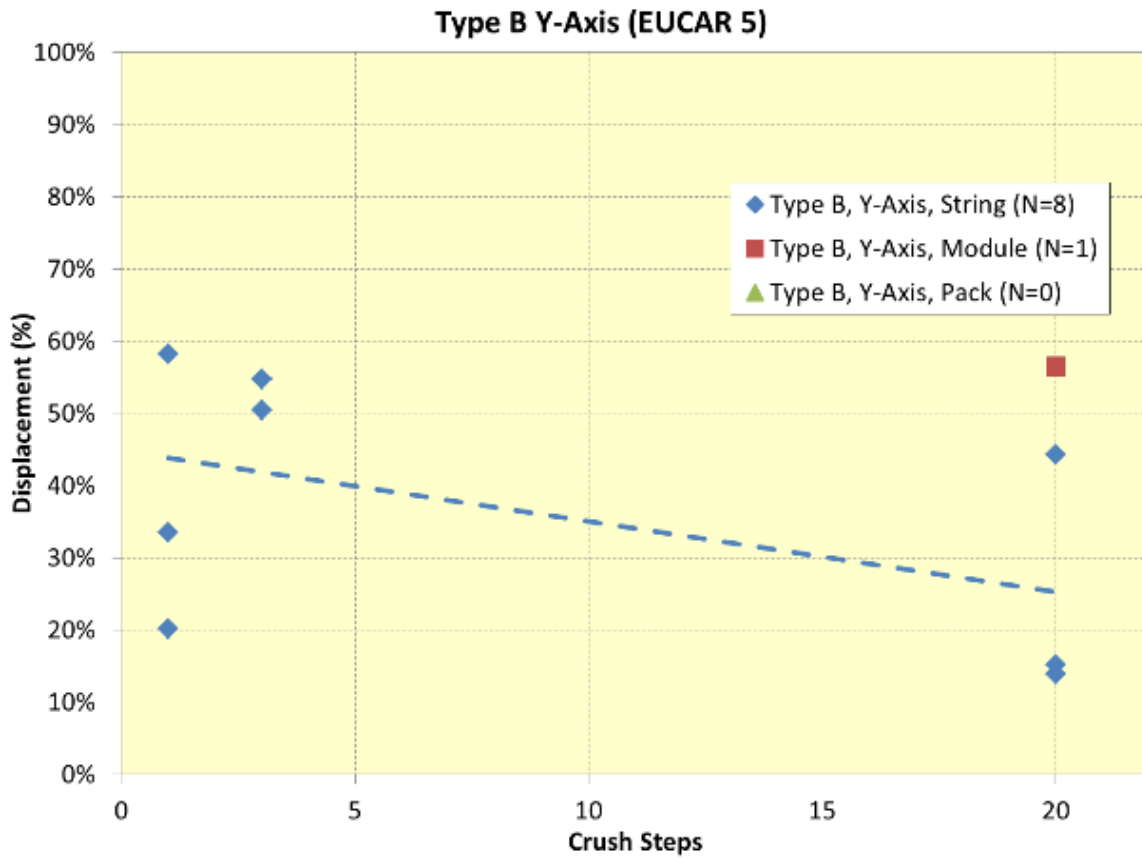


Figure 94 Type B Y-Axis (EUCAR 5)



**Figure 95 Y-Axis 20-Step String Type B Pre-Test Fixture (CRY20SB01)**



**Figure 96 Y-Axis 20-Step String Type B Post-Test Fixture (CRY20SB01)**

Type B Z-Axis results continue the trend of the Z-Axis EUCAR 5 displacement percentage values being larger than in other axes. The same hardware in the Z-Axis gave a tighter grouping than what was seen in the Y-axis.

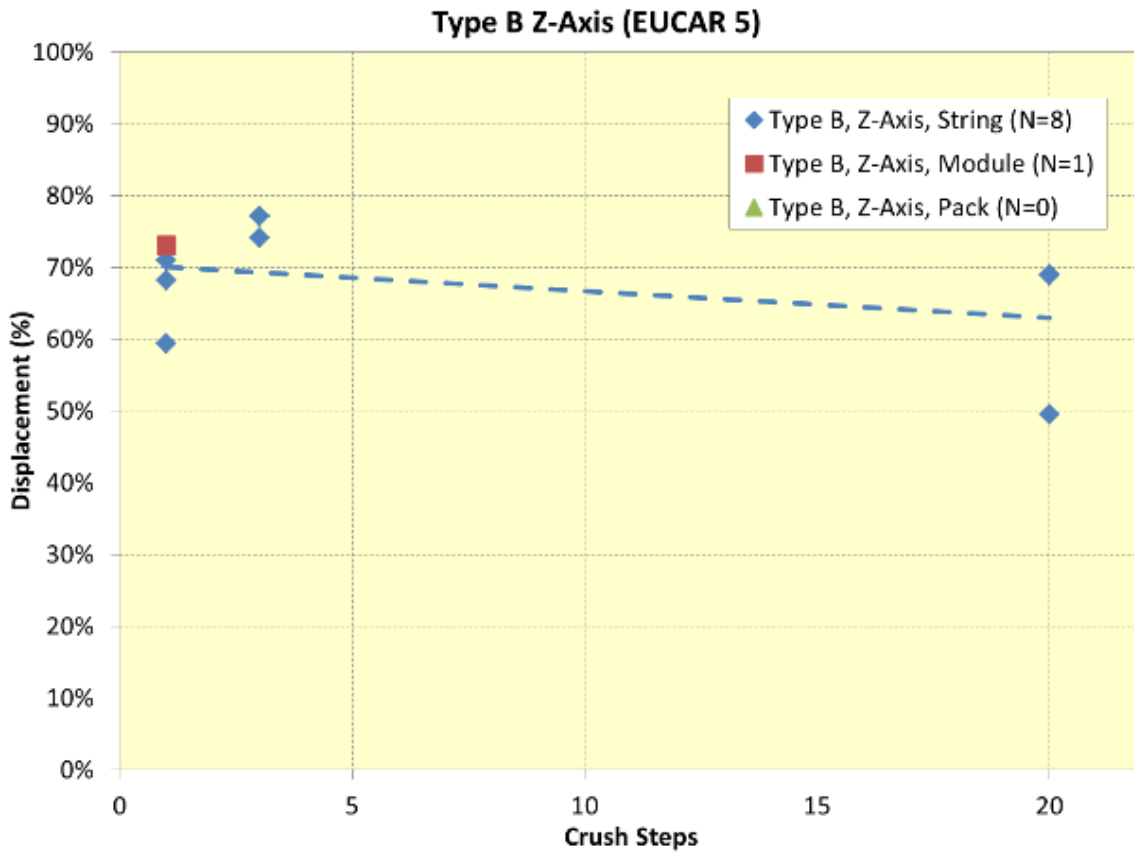


Figure 97 Type B Z-Axis (EUCAR 5)





**Figure 98 Z-Axis 20-Step String Type B Pre-Test Fixture (CR032)**



**Figure 99 Z-Axis 20-Step String Type B Post-Test Fixture (CR032)**

### 10.5.7. Type C

The Type C data primarily is made up of string and pack level results. The large spread of hardware size can provide a useful insight into the correlations with size and energy content.

Type C X-Axis data shows a relatively tight group at all crush interval levels. Displacement values of greater than 15 percent are required to trigger a EUCAR 5 result in this condition.

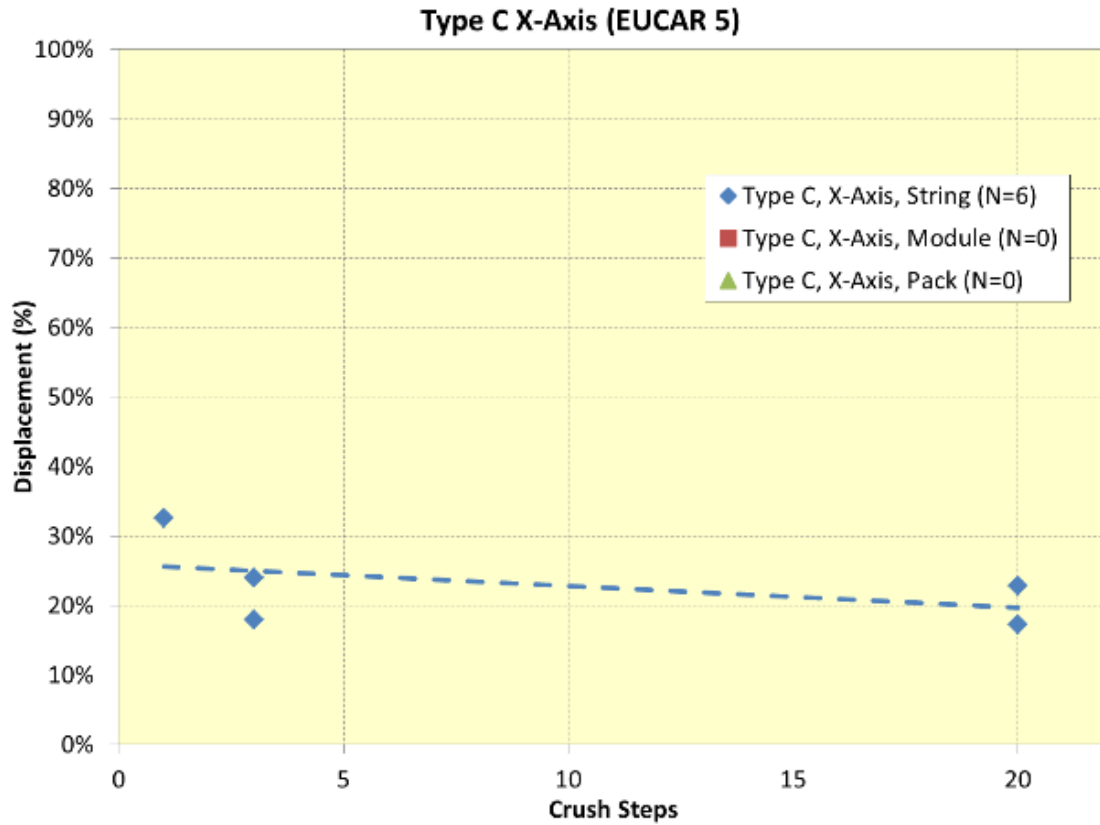


Figure 100 Type C X-Axis (EUCAR 5)



**Figure 101 X-Axis 20-Step String Type C Pre-Test Fixture (CR044)**



**Figure 102 X-Axis 20-Step String Type C Post-Test Fixture (CR044)**

Evaluating the EUCAR 5 displacement of Type C Y-Axis crush yields only pack level data. Although 6 string level units were tested for this condition, none reached a EUCAR 5, likely due to their motion out of the axis of crush, was previously discussed. Due to the mechanical reinforcement, at the pack level, the cells are able to be fully engaged and their results are in line with other hardware and other axis.

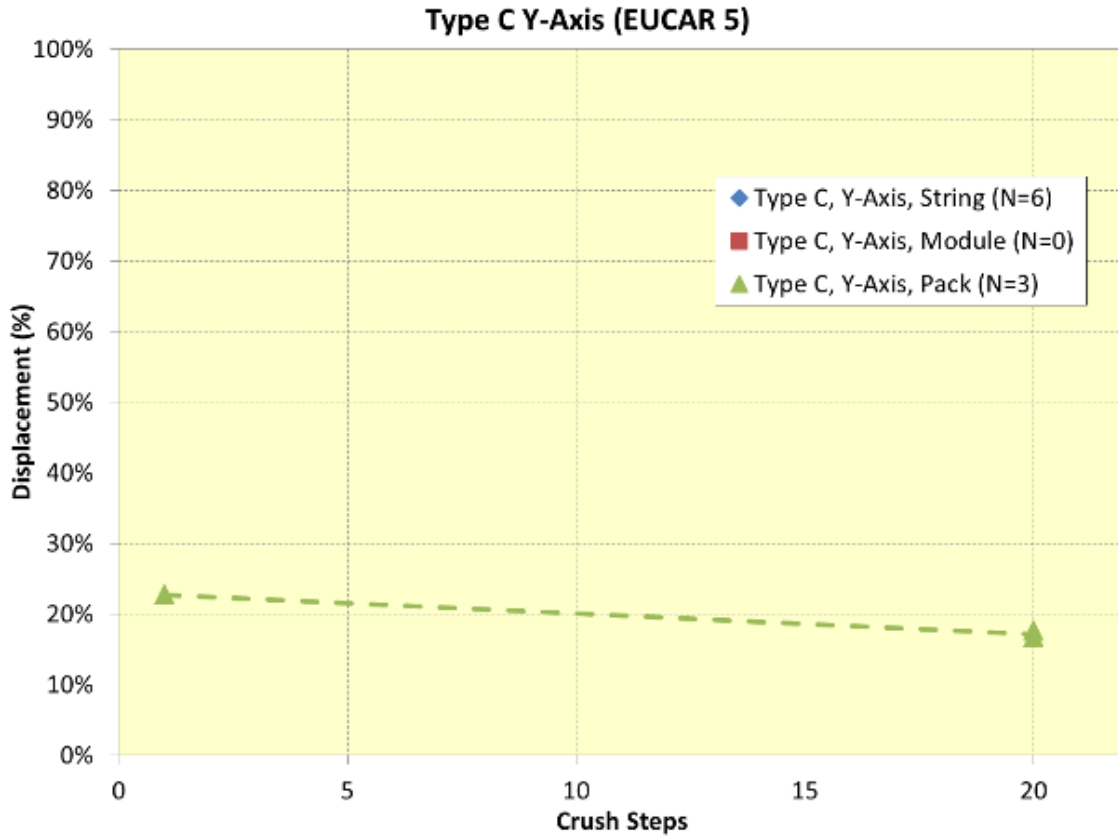


Figure 103 Type C Y-Axis (EUCAR 5)



Figure 104 Y-Axis 20-Step String Type C Pre-Test Fixture (CR049)



Figure 105 Y-Axis 20-Step String Type C Post-Test Fixture (CR049)

A review of the Type C Z-Axis results shows that hardware level can have a large impact on the displacement percentage of EUCAR 5. This result is likely at least partially due to the tendency of smaller hardware levels (i.e., strings) to move out of the way of the crush, not seen as much in pack testing.

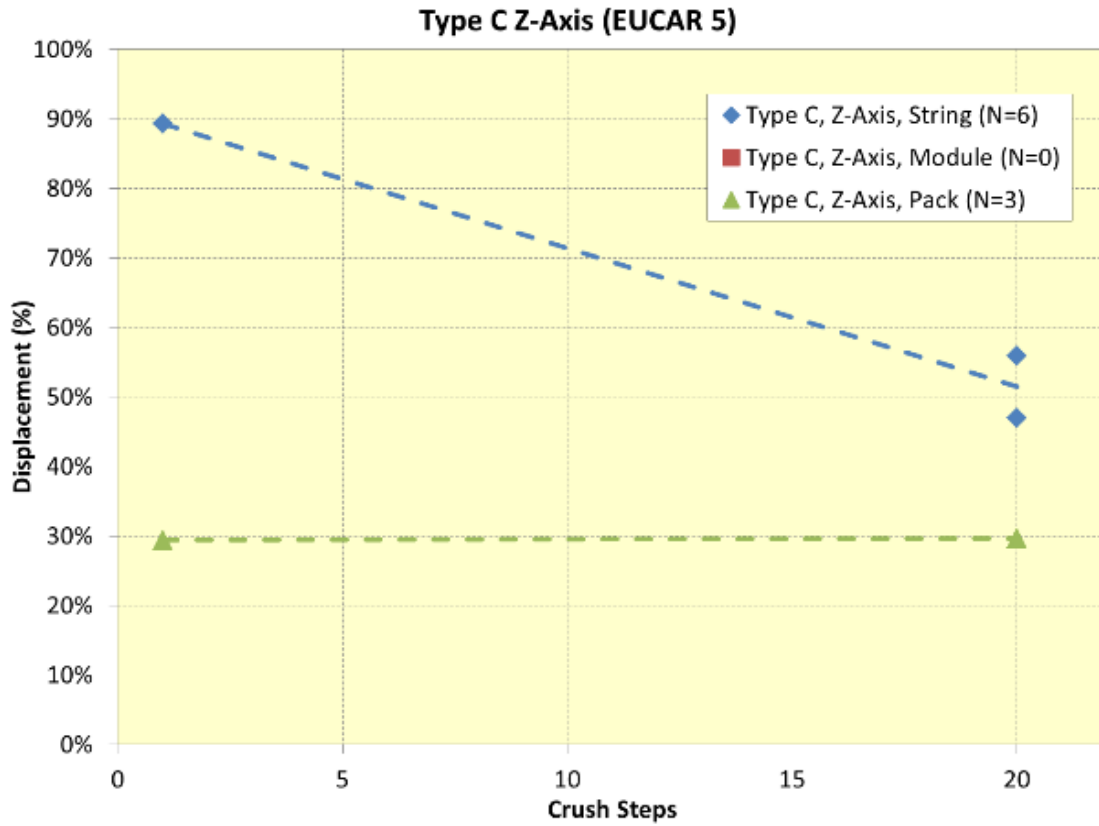


Figure 106 Type C Z-Axis (EUCAR 5)



**Figure 107 Z-Axis 20-Step String Type C Pre-Test Fixture (CR041)**



**Figure 108 Z-Axis 20-Step String Type C Post-Test Fixture (CR041)**

### 10.5.8. Pack

The pack testing activity was divided amongst 6 units each of Type A and Type C units of very similar energy content. The Type A hardware had two units tested in 20-steps in each direction resulting in 5 data points (one test hit a machine load limit). The Type C hardware would not physically fit in the X-Axis direction, so that type was tested in 3 iterations (x1 1-step and x2 20-step) in the Y and Z-Axis.

The test results show a high level of result consistency and relative insensitivity to number of crush steps in the case of the Type C units. The Type A results are very tight and show a slight rise in the displacement achievable from X (~20%) to Y (~30%) and onto Z-Axis (~45%) directions. The Type C units showed a similar level of consistency and increasing values from Y (~20%) to Z-Axis (~30%).

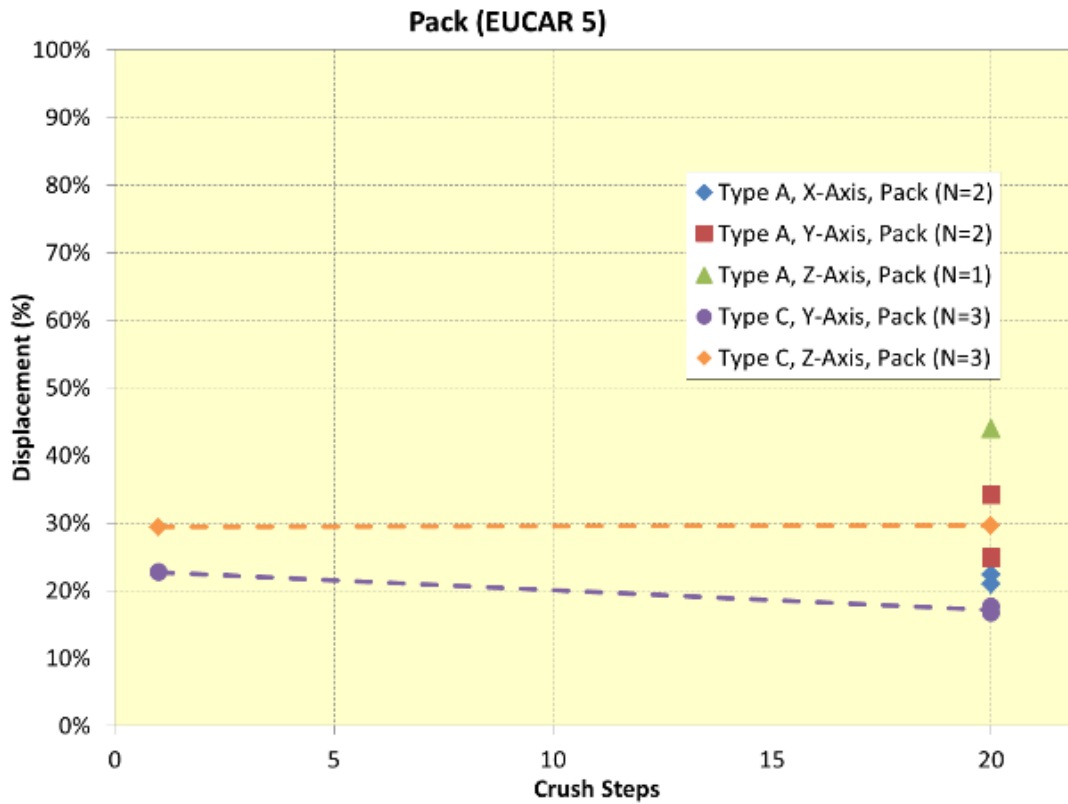
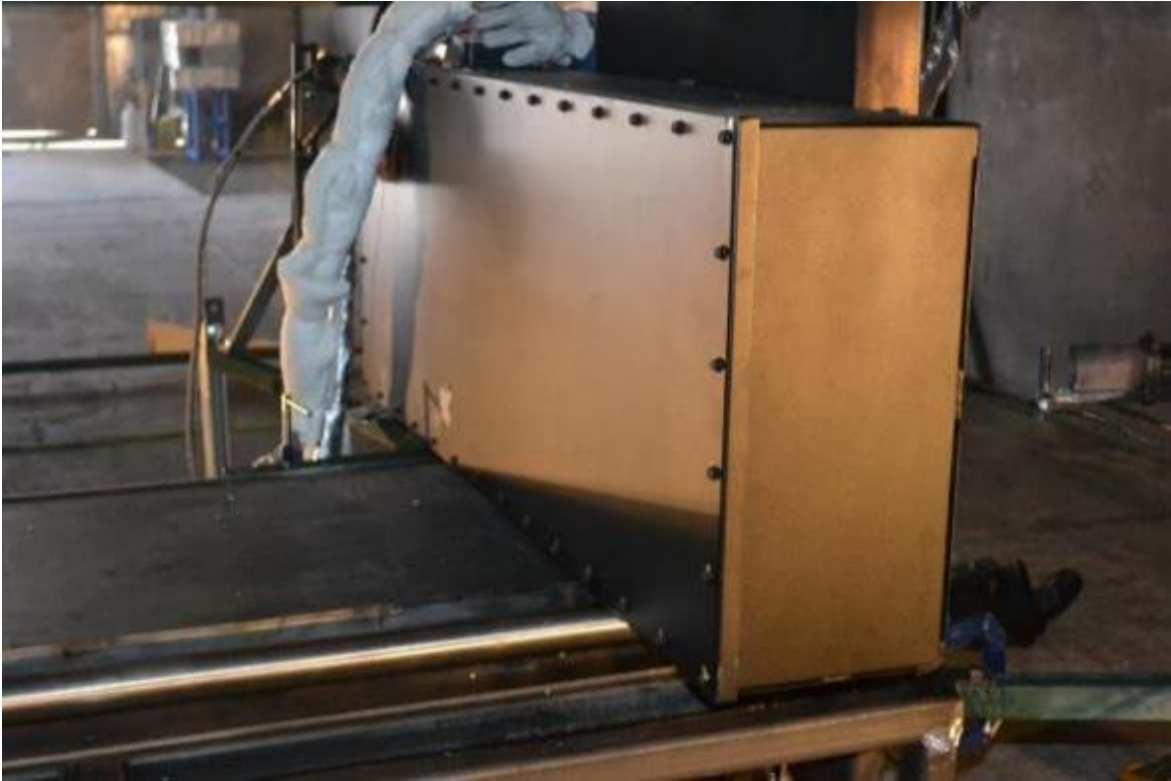


Figure 109 Pack (EUCAR 5)





**Figure 110 Y-Axis 20-Step Pack Type C Pre-Test Fixture (5)**



**Figure 111 Y-Axis 20-Step Pack Type C Post-Test Fixture (5)**



**Figure 112 Z-Axis 20-Step Pack Type C Pre-Test Fixture (6)**



**Figure 113 Z-Axis 20-Step Pack Type C Post-Test Fixture (6)**

## 10.6. Overcharge Analysis

As this project evolved, the overcharge testing focus evolved from the initial focus on maintaining a variety of constant electrical inputs (constant current, voltage and power), to the more practical and relevant approach of evaluating the impact of various levels of constant current delivery. In addition to varying current, in an effort to discretize the point of reaction, a start-stop pattern of 5 percent steps was tested side by side with continuous overcharge patterns.

### 10.6.1. Overcharge Summary

The review of overcharge test results focused on the response of the hardware (EUCAR level) as a function to its state of charge percentage. This analysis used the voltage and current signals from the device as is shown in Figure 114.

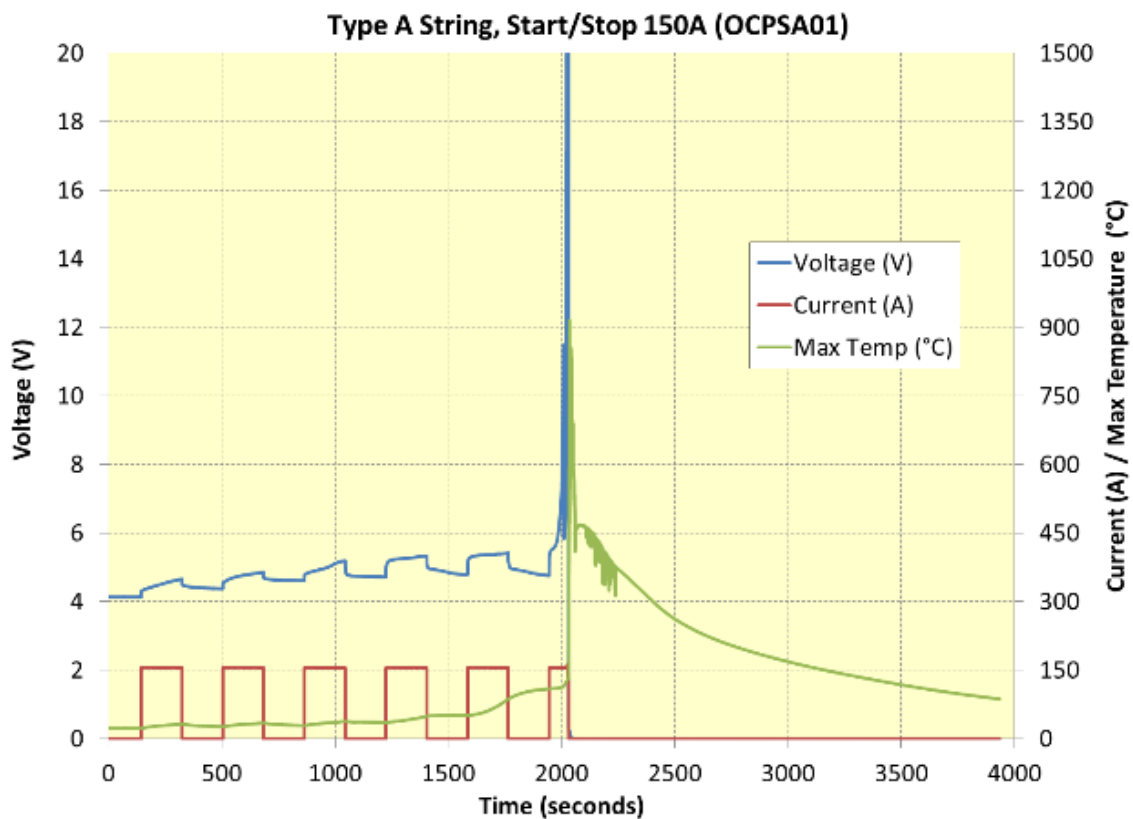


Figure 114 Overcharge Response of Type A String, Start/Stop 150A (OCPSA01)

The review of 48 overcharge tests and their state of charge during the occurrence of EUCAR 5 events is shown in Figure 115. It can be seen that the state of charge of an event does not correlate strongly with current through the range of 25 to 275As.

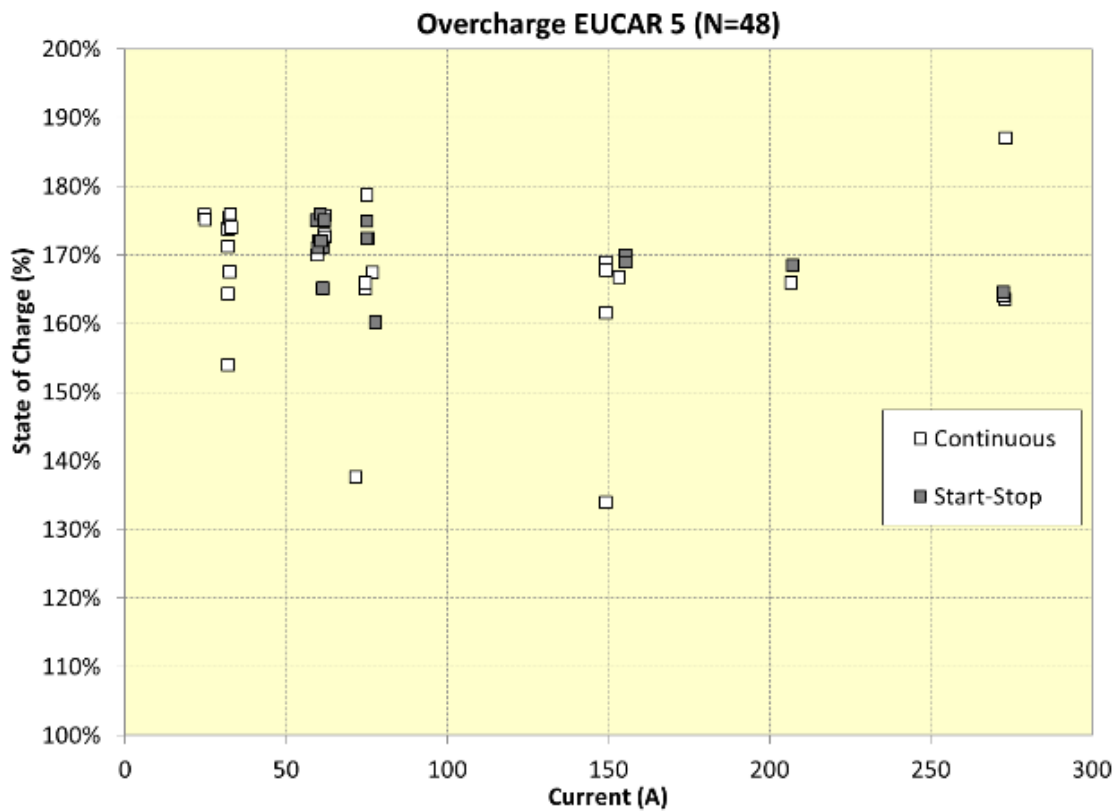


Figure 115 Overcharge Analysis Data

Figure 116 summarizes the EUCAR 5 response state of charges of all the overcharge tests performed using the same color convention as was described for Figure 44. All the start-stop pattern tests featured EUCAR 5 events within a relatively narrow band of state of charges ranging from 160 percent to 176 percent. The continuous tests yielded a large span of state of charges for events (53%), however no EUCAR 5 event occurred prior to reaching >134 percent state of charge.



Figure 116 Overcharge Analysis Summary

### 10.6.2. Continuous

This section provides a review of the overcharge testing results by test condition (continuous versus start/stop). This analysis helps to differentiate between the procedures impact relative to different hardware types/levels and currents.

A comparison of Continuous string results is shown below. The state of charge percentage at EUCAR 5 is very insensitive to the applied current for the population and each individual hardware type for this condition. The Type A and B hardware show very similar state of charge percentage at EUCAR 5 regardless of current (i.e., ranging from 160 to 180%). The Type C hardware was also insensitive to current but displayed values in the 130 to 140 percent range.

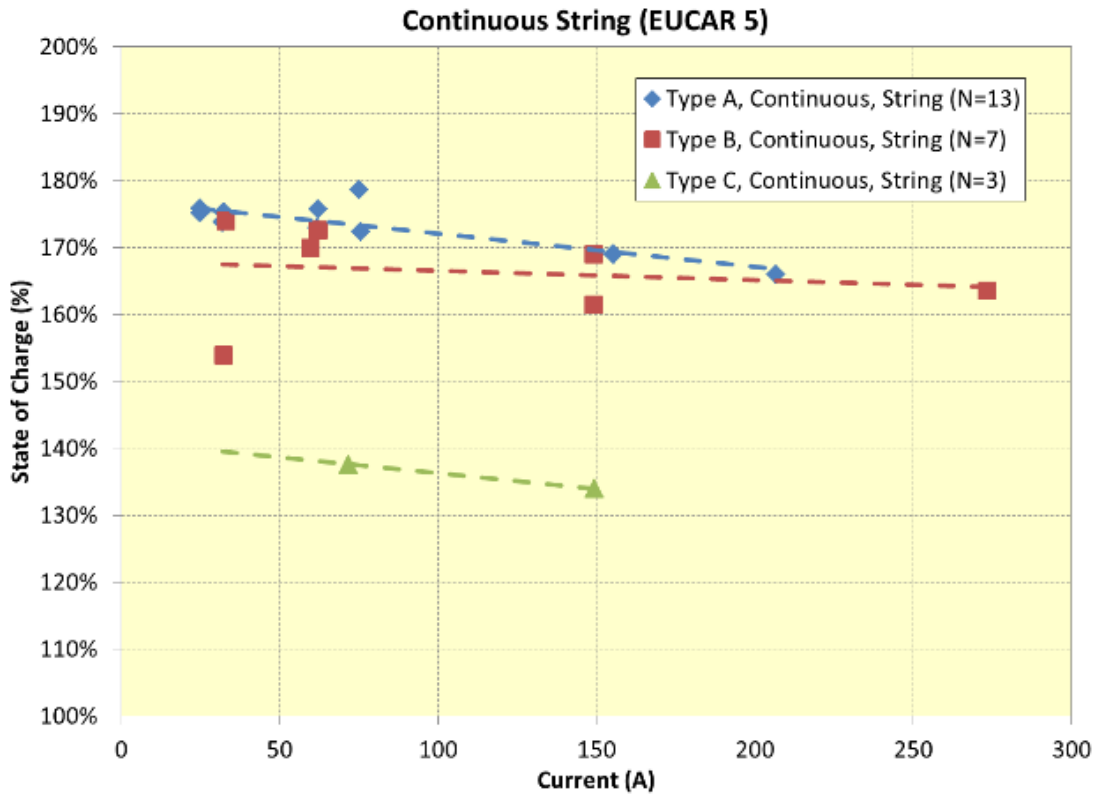


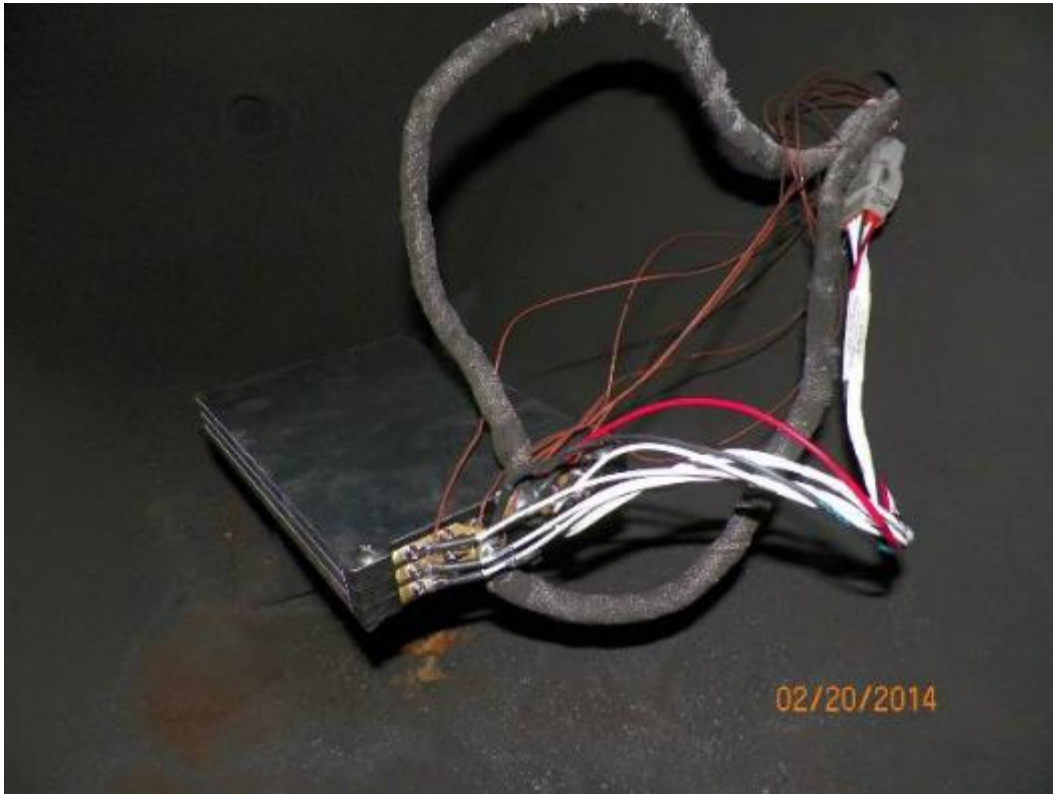
Figure 117 Continuous String (EUCAR 5)



**Figure 118 Continuous 32A String Type A Pre-Test Fixture (OCICA02)**



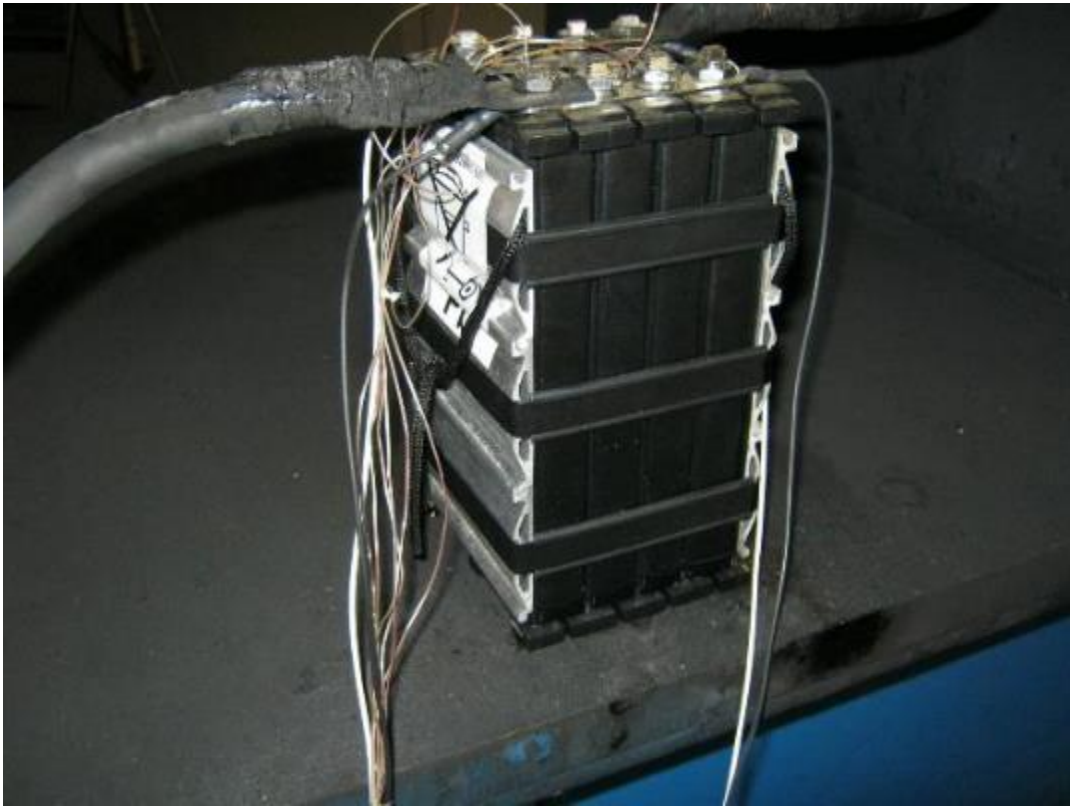
**Figure 119 Continuous 32A String Type A Post-Test Fixture (OCICA02)**



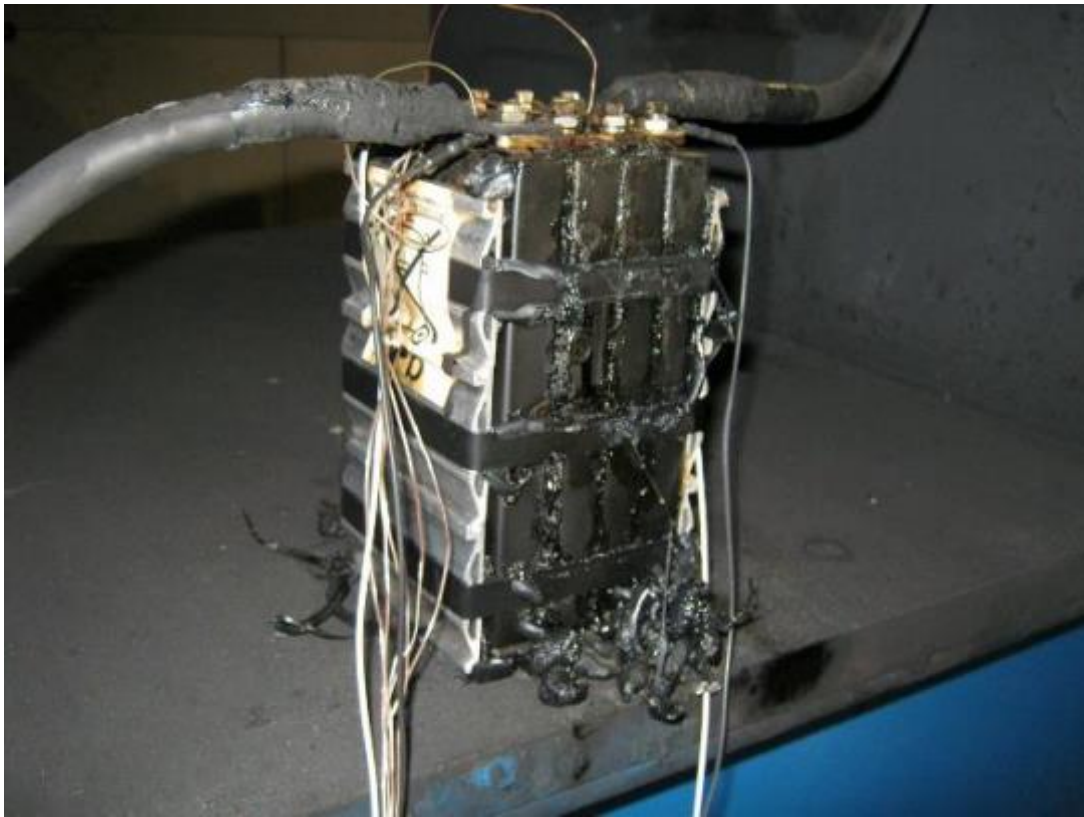
**Figure 120 Continuous 32A String Type B Pre-Test Fixture (OCICB01)**



**Figure 121 Continuous 32A String Type B Post-Test Fixture (OCICB01)**



**Figure 122 Continuous 72A String Type C Pre-Test Fixture (OC048)**



**Figure 123 Continuous 72A String Type C Post-Test Fixture (OC048)**



A review of the continuous module data is shown below. For the Type B and C conditions, no EUCAR 5 event occurs before 160 percent state of charge, very similar to the string condition. The modules show some sensitivity to current, but with relatively modest slopes.

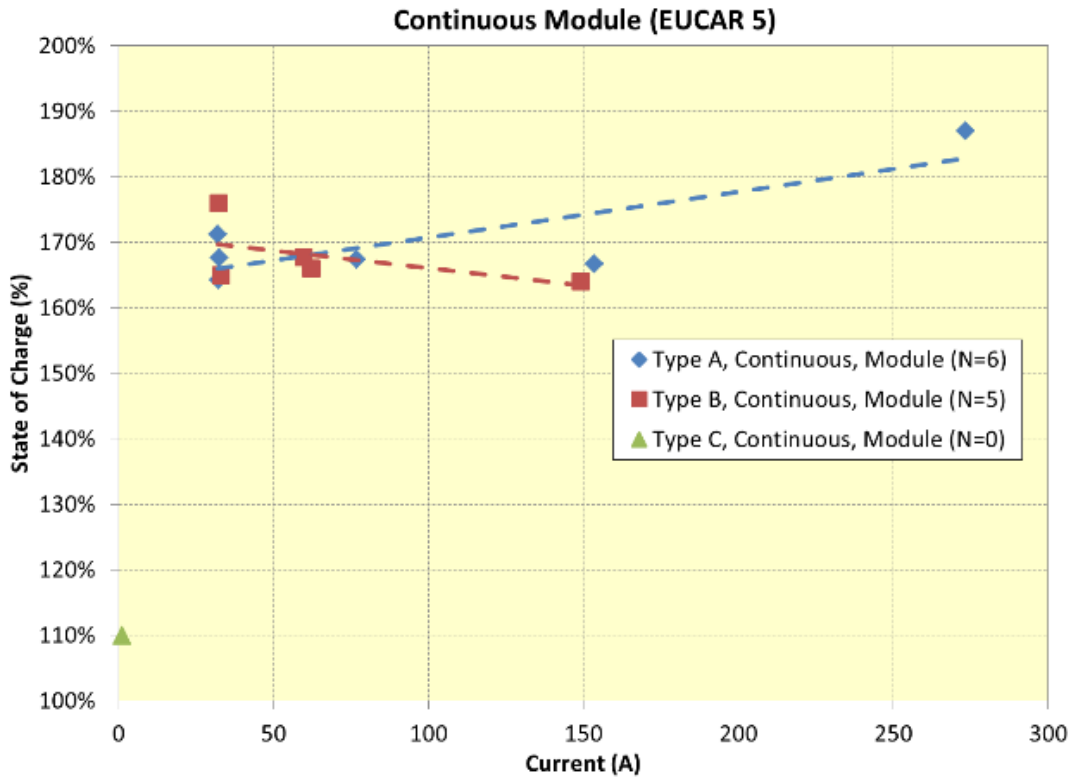
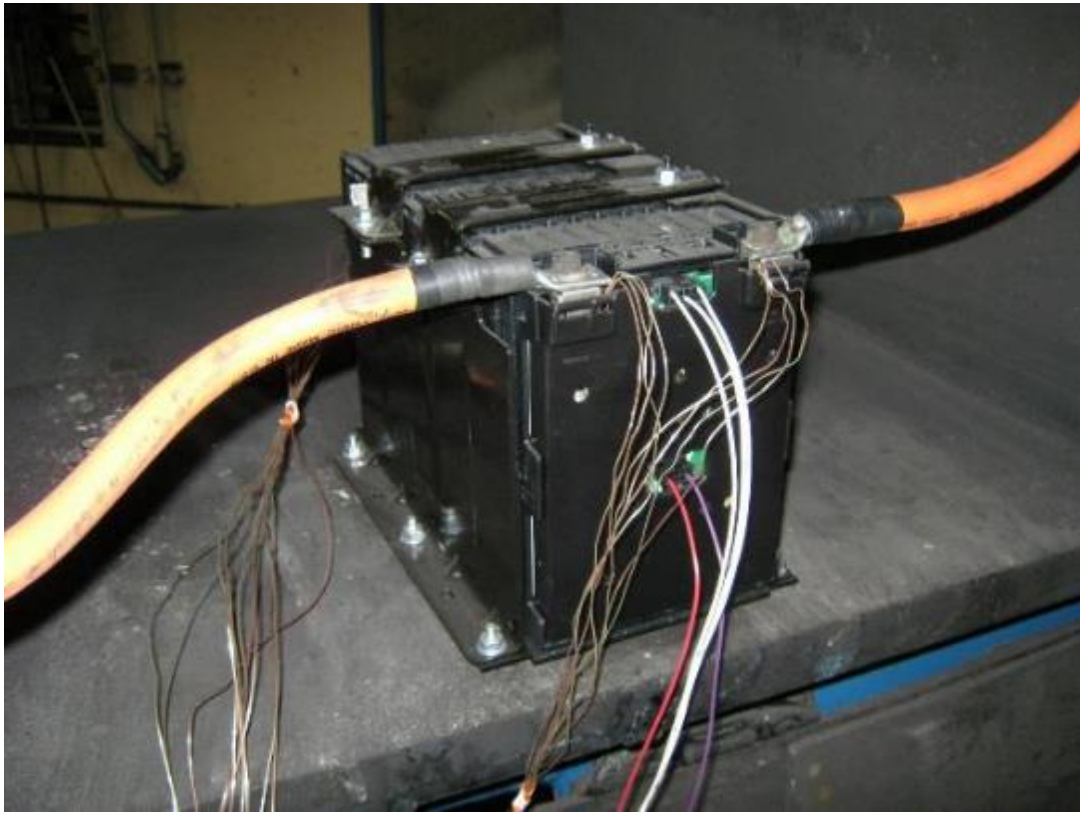


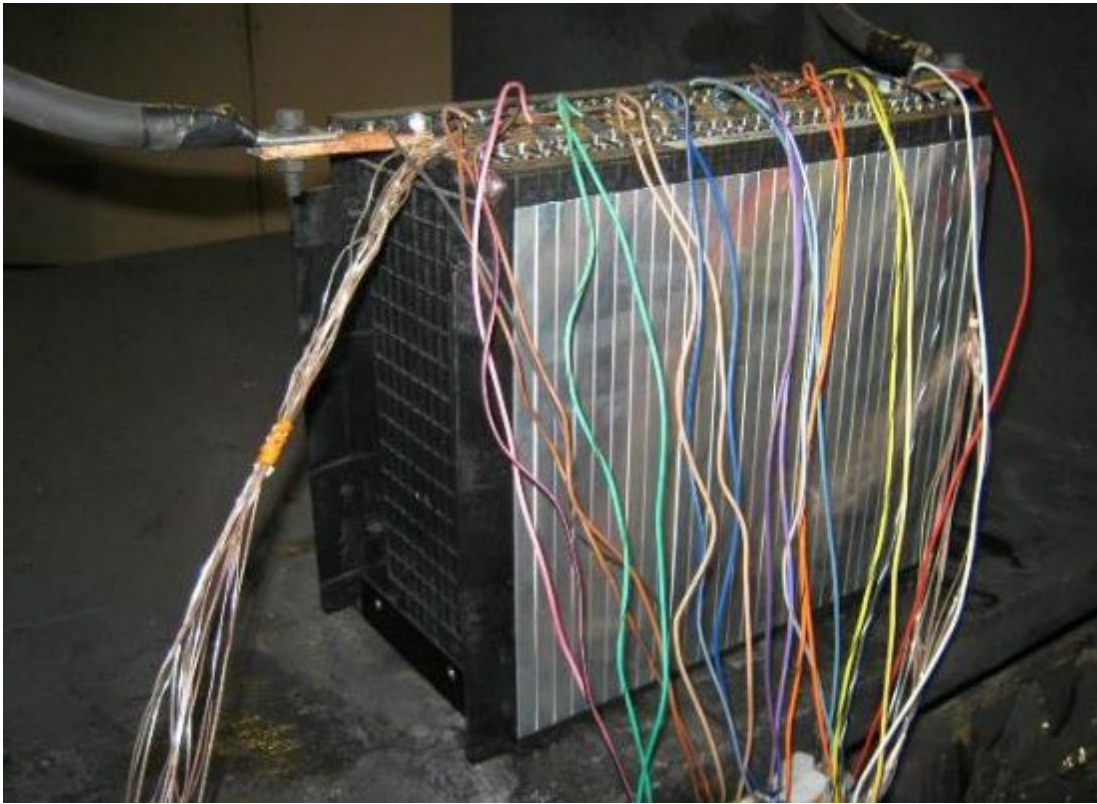
Figure 124 Continuous Module (EUCAR 5)



**Figure 125 Continuous 77A Module Type A Pre-Test Fixture (OC24)**



**Figure 126 Continuous 77A Module Type A Post-Test Fixture (OC24)**



**Figure 127 Continuous 75A Module Type B Pre-Test Fixture (OC041)**



**Figure 128 Continuous 75A Module Type B Post-Test Fixture (OC041)**

### 10.6.3. Start/Stop

A study of the start/stop condition is described in this section. with some exceptions, the results of the start/stop condition echo those of the continuous, showing a relative insensitivity of hardware to the pattern of the procedure.

A comparison of the start/stop Type A, B and C string results is shown below. As previous Type A and B conditions, no EUCAR 5 events occurred prior to 160 percent state of charge and showed mild correlations with currents. Two examples of Type C strings were test under the stop/start condition at 72A and both reached approximately 200 percent SOC without a EUCAR 5.

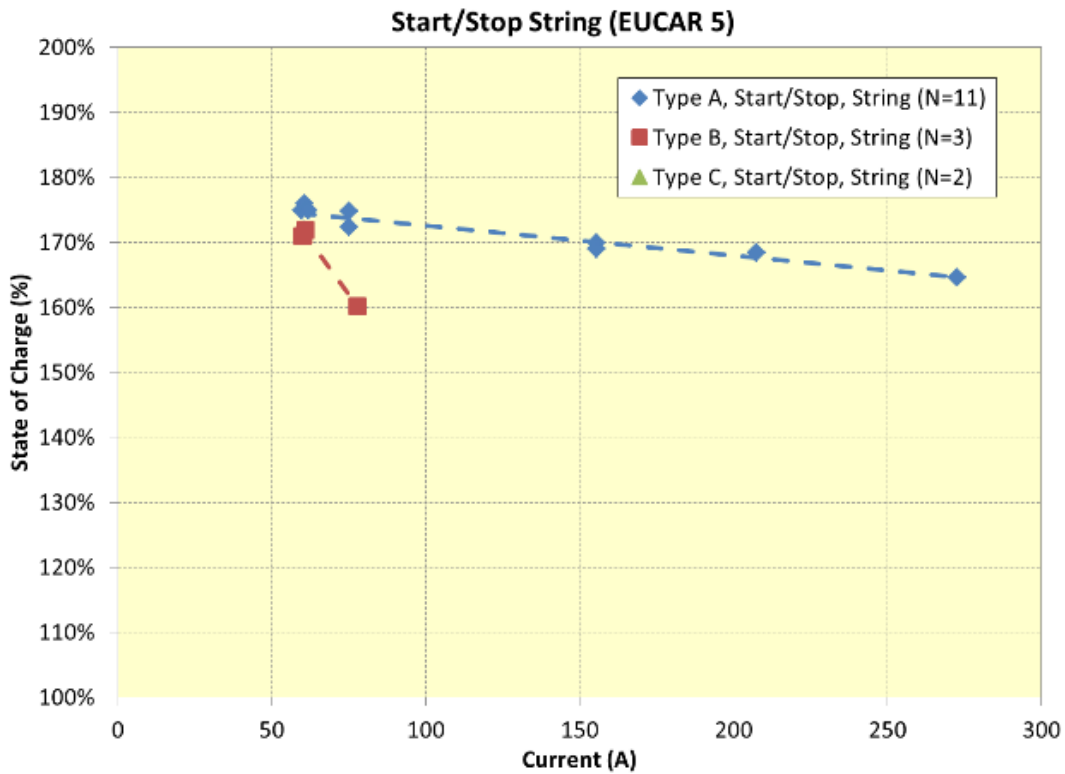


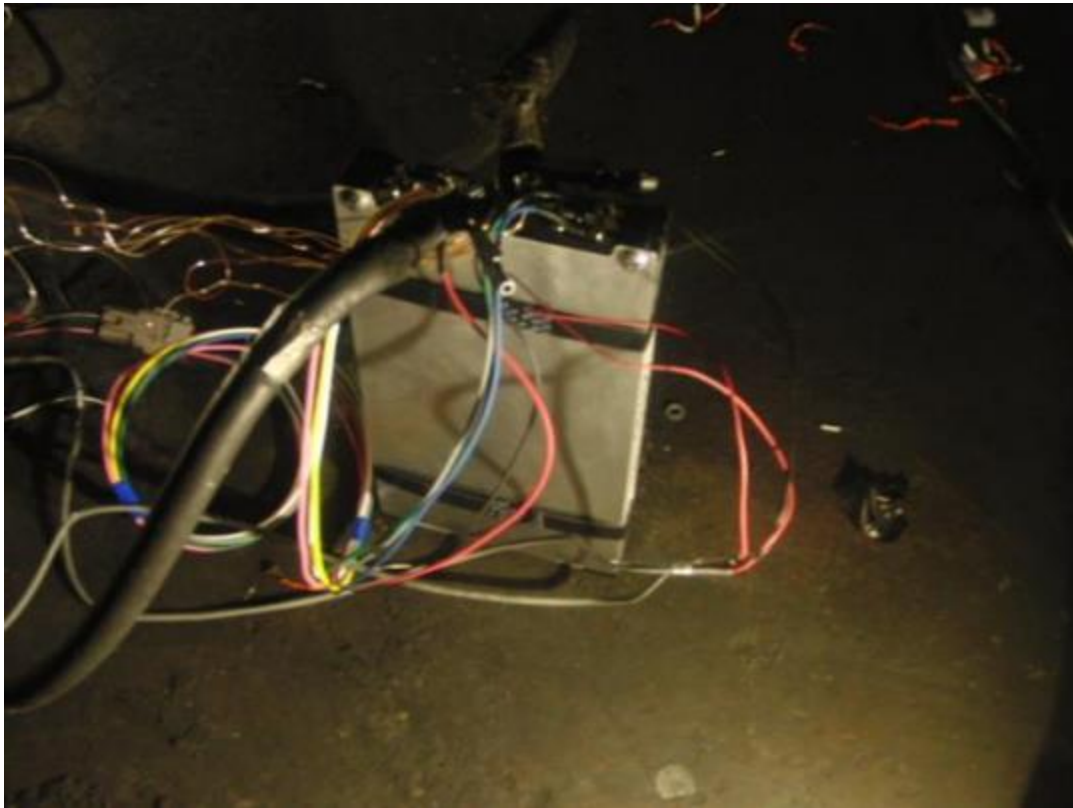
Figure 129 Start/Stop String (EUCAR 5)



**Figure 130 Start/Stop 60A String Type A Pre-Test Fixture (OCISA01)**



**Figure 131 Start/Stop 60A String Type A Post-Test Fixture (OCISA01)**



**Figure 132 Start/Stop 60A String Type B Pre-Test Fixture (OC009)**



**Figure 133 Start/Stop 60A String Type B Post-Test Fixture (OC009)**

The start/stop module level testing focused on the Type A hardware. The results are in line with the string values previously shown for the start/stop pattern and for the string/module continuous data.

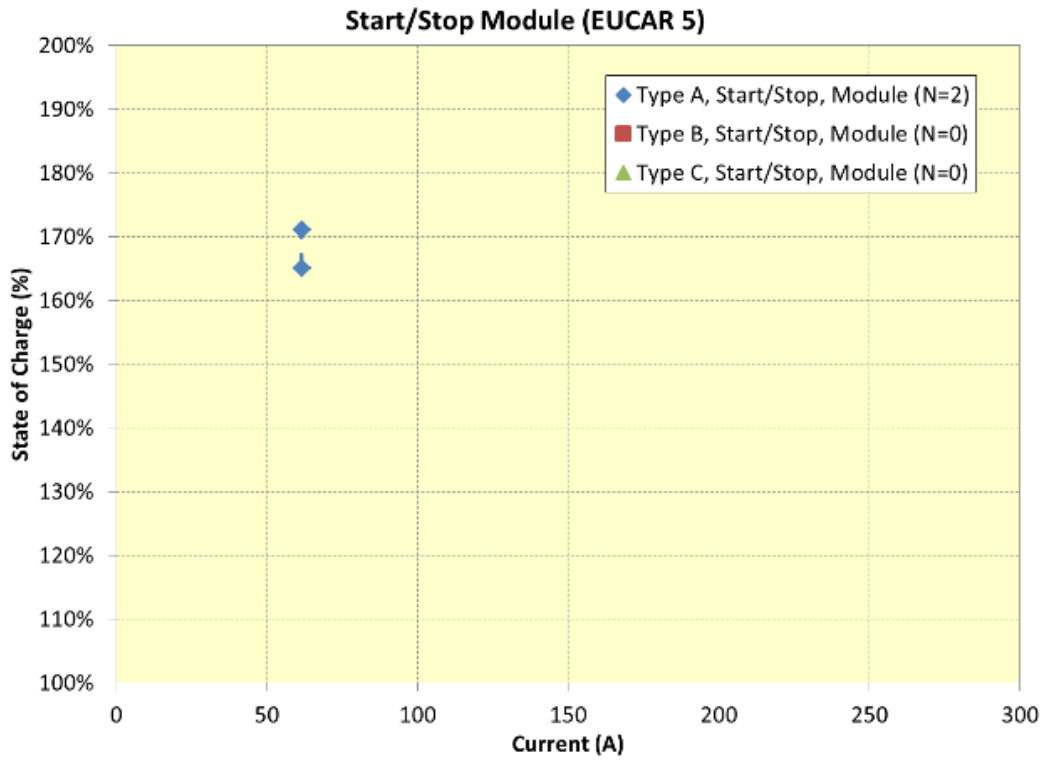


Figure 134 Start/Stop Module (EUCAR 5)



**Figure 135 Start/Stop 61A Module Type A Pre-Test Fixture (OC027)**



**Figure 136 Start/Stop 61A Module Type A Post-Test Fixture (OC027)**



### 10.6.4. Type A

The Type A hardware data is reviewed in this section. The plots of this section compare the string and module overcharge test results in the two main project test patterns, continuous and stop/start.

The continuous test pattern delivered similar results at both the string and module Type A level as is shown below. The range of state of charge percentage indicating a EUCAR 5 response was consistently between 160 and 180 percent.

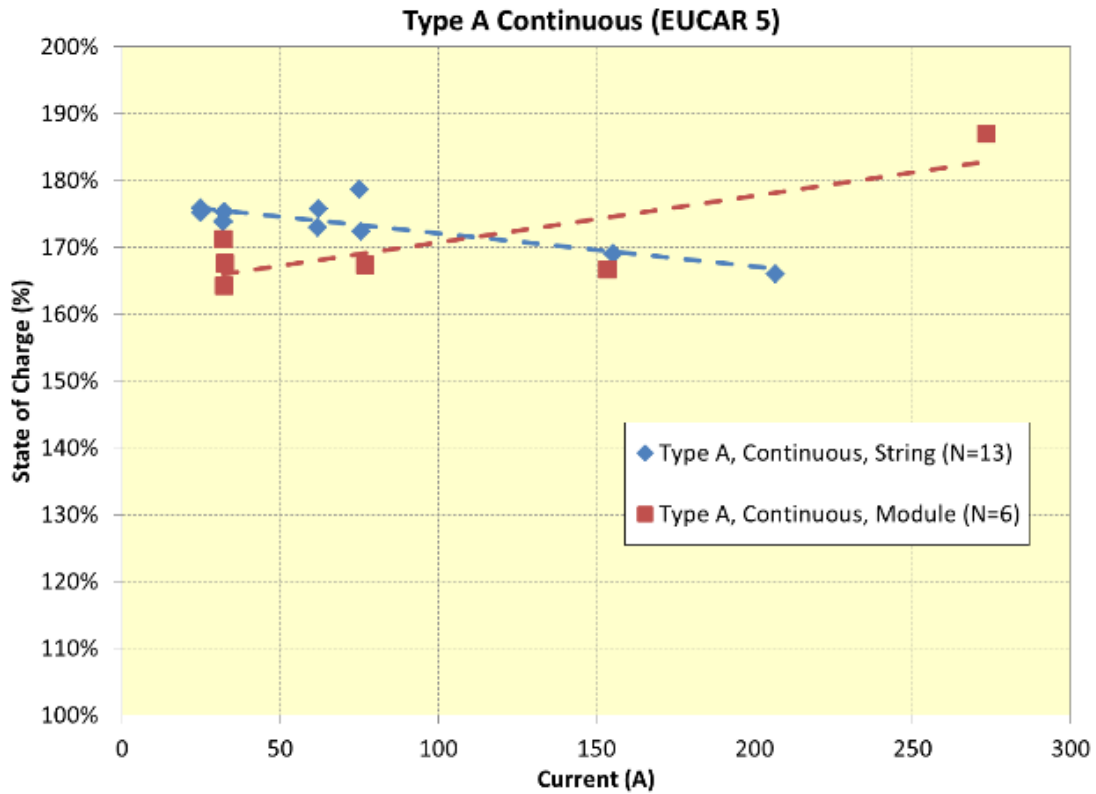


Figure 137 Type A Continuous (EUCAR 5)



**Figure 138 Continuous 155A String Type A Pre-Test Fixture (OCPCA02)**



**Figure 139 Continuous 155A String Type A Post-Test Fixture (OCPCA02)**



**Figure 140 Continuous 153A Module Type A Pre-Test Fixture (OC025)**



**Figure 141 Continuous 153A Module Type A Post-Test Fixture (OC025)**

The start/stop overcharge test pattern performance in the Type A hardware (both strings and modules) is shown below. The strings followed a highly linear pattern with a very little degree of spread about its slope line with current. The module testing only featured two units, but the state of charge of its response fell well within band shown in the string level.

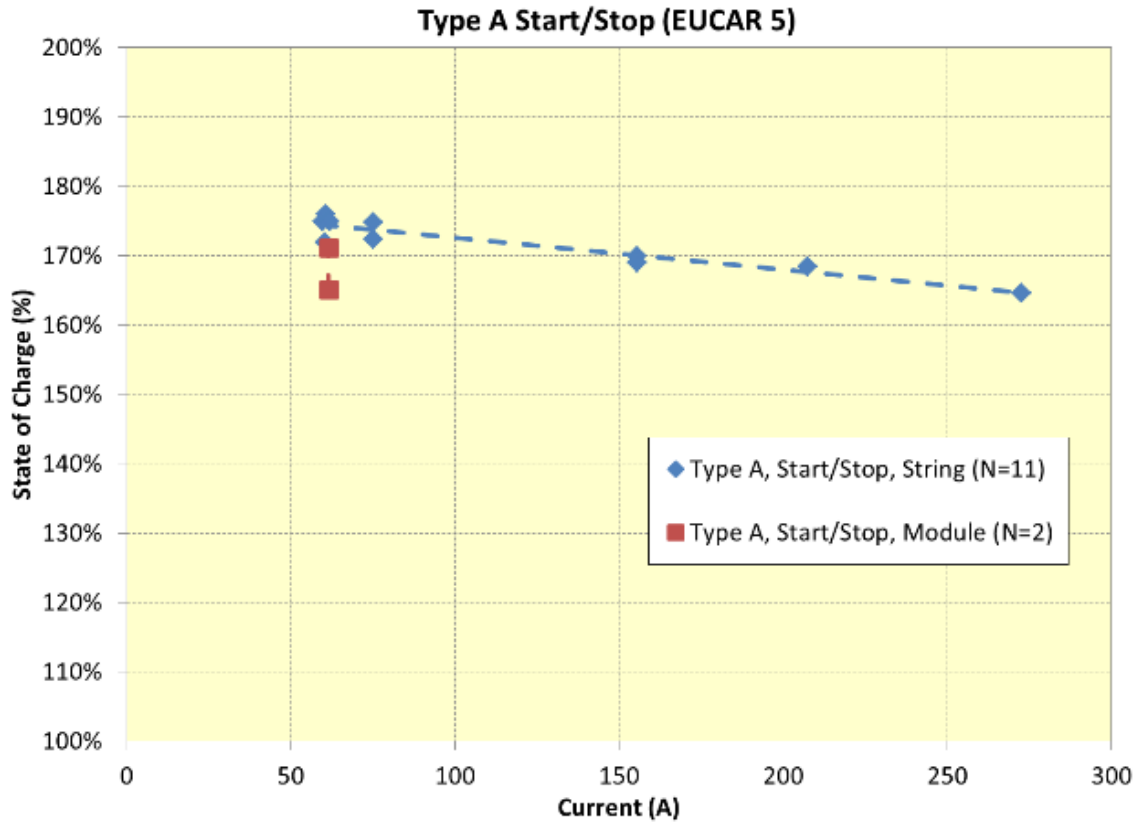


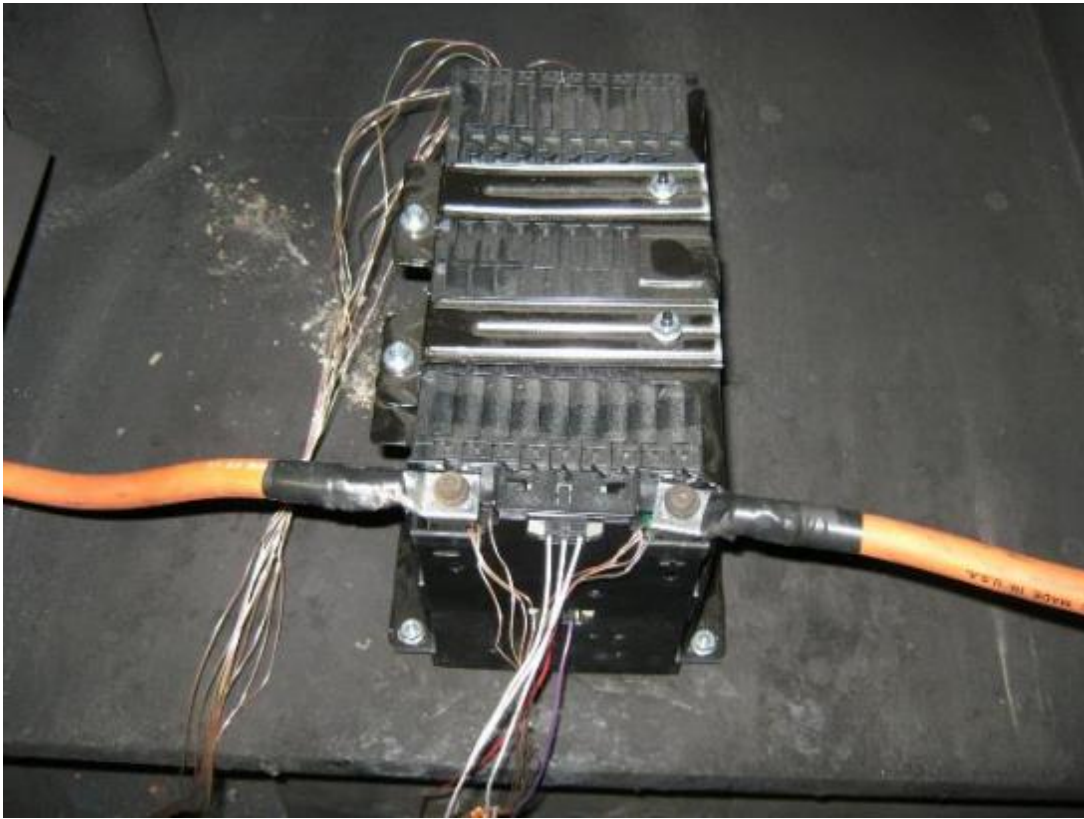
Figure 142 Type A Start/Stop (EUCAR 5)



**Figure 143 Start/Stop 155A String Type A Pre-Test Fixture (OCPSA01)**



**Figure 144 Start/Stop 155A String Type A Post-Test Fixture (OCPSA01)**



**Figure 145 Start/stop 60A Module Type A Pre-Test Fixture (OC028)**



**Figure 146 Start/stop 60A Module Type A Post-Test Fixture (OC028)**

### 10.6.5. Type B

This section compares the Type B string and modules units tested under both the continuous and start/stop conditions.

The continuous string and module test results show almost identical linear regression lines near 165 percent state of charge, regardless of current.

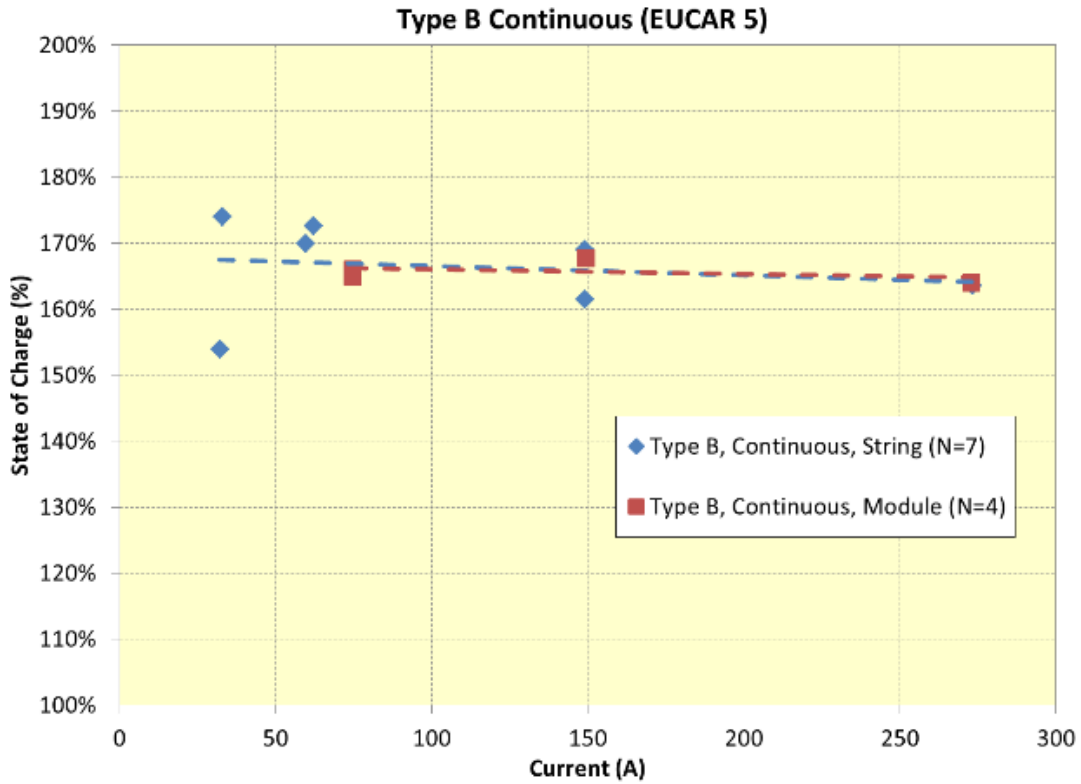


Figure 147 Type B Continuous (EUCAR 5)

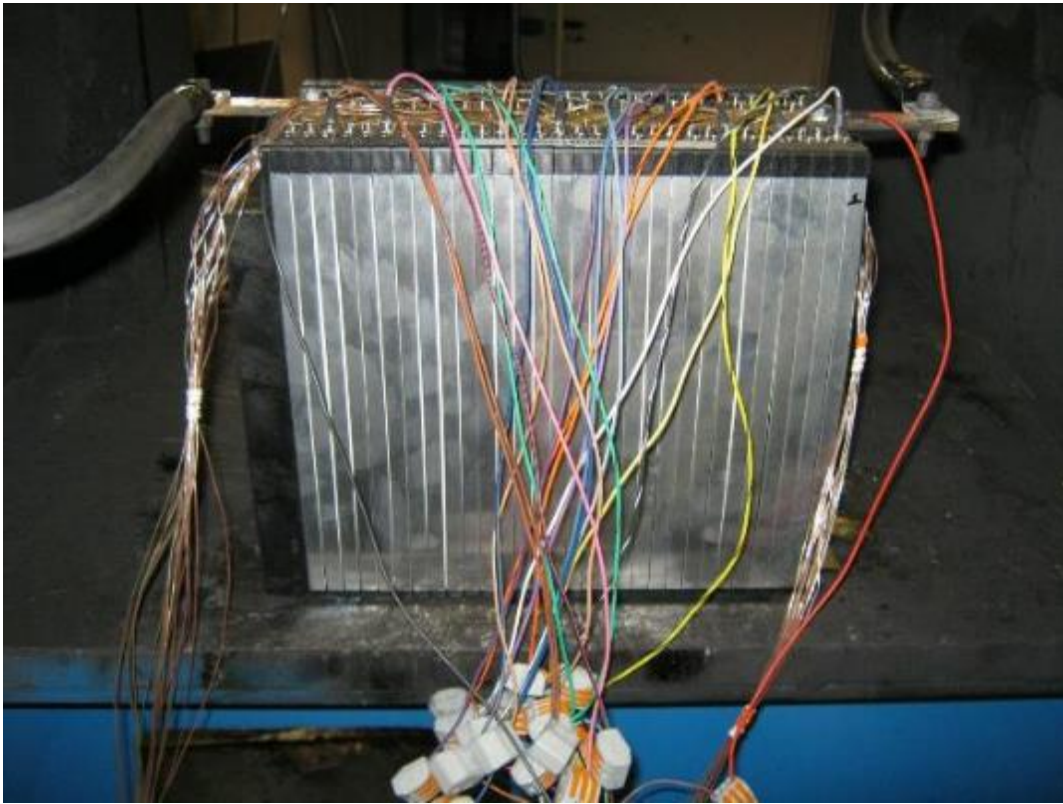


**Figure 148 Continuous 149A String Type B Pre-Test Fixture (OC035)**



**Figure 149 Continuous 149A String Type B Post-Test Fixture (OC035)**





**Figure 150 Continuous 149A Module Type B Pre-Test Fixture (OC044)**



**Figure 151 Continuous 149A Module Type B Post-Test Fixture (OC044)**

The start/stop string results for Type B are shown below. Within the type and test condition the limited current values test show a range of responses between 160 and 170 percent, in line with other testing.

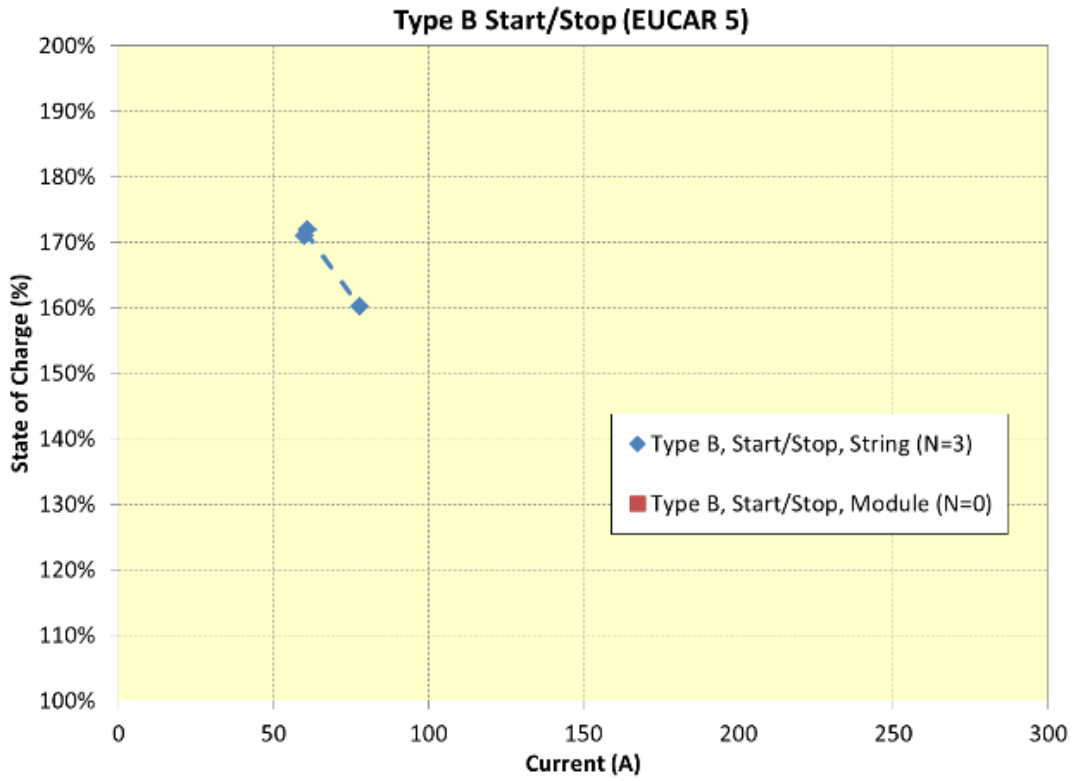
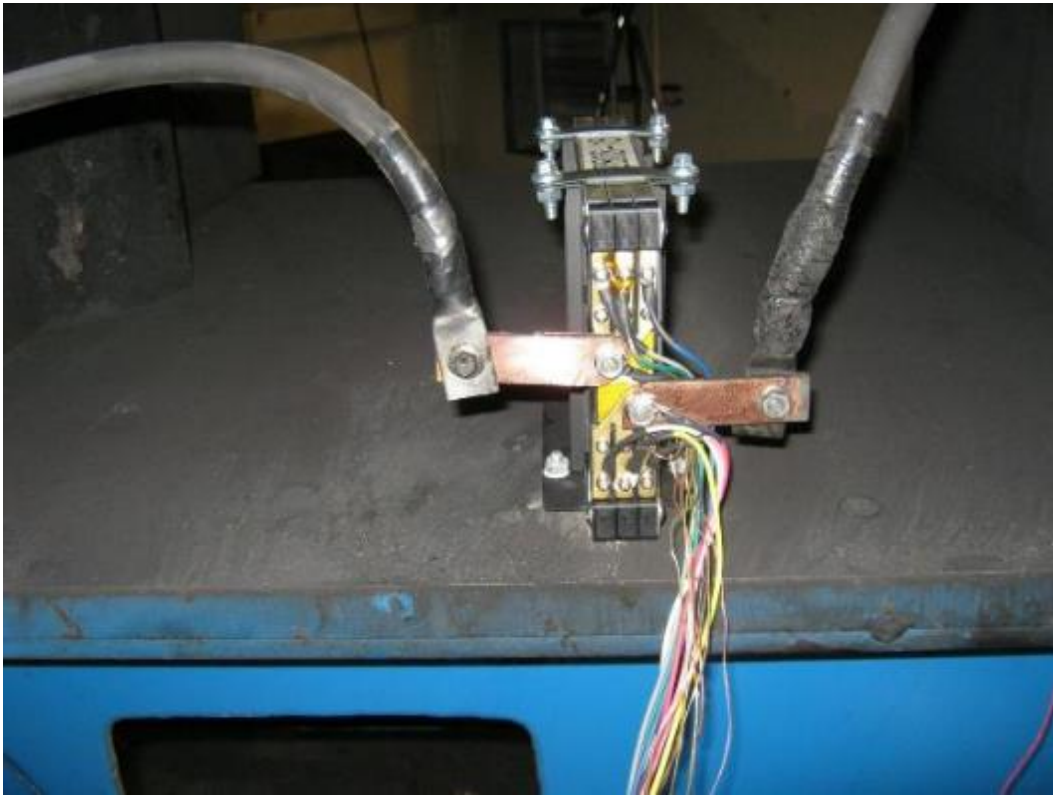


Figure 152 Type B Start/Stop (EUCAR 5)



**Figure 153 Start/Stop 77A String Type B Pre-Test Fixture (OC038)**



**Figure 154 Start/Stop 77A String Type B Post-Test Fixture (OC038)**

### 10.6.6. Type C

This section focuses on the Type C test results for both overcharge conditions (continuous and start/stop).

Below, the Type C continuous string results shown previously are reiterated. No module level data is available for comparison.

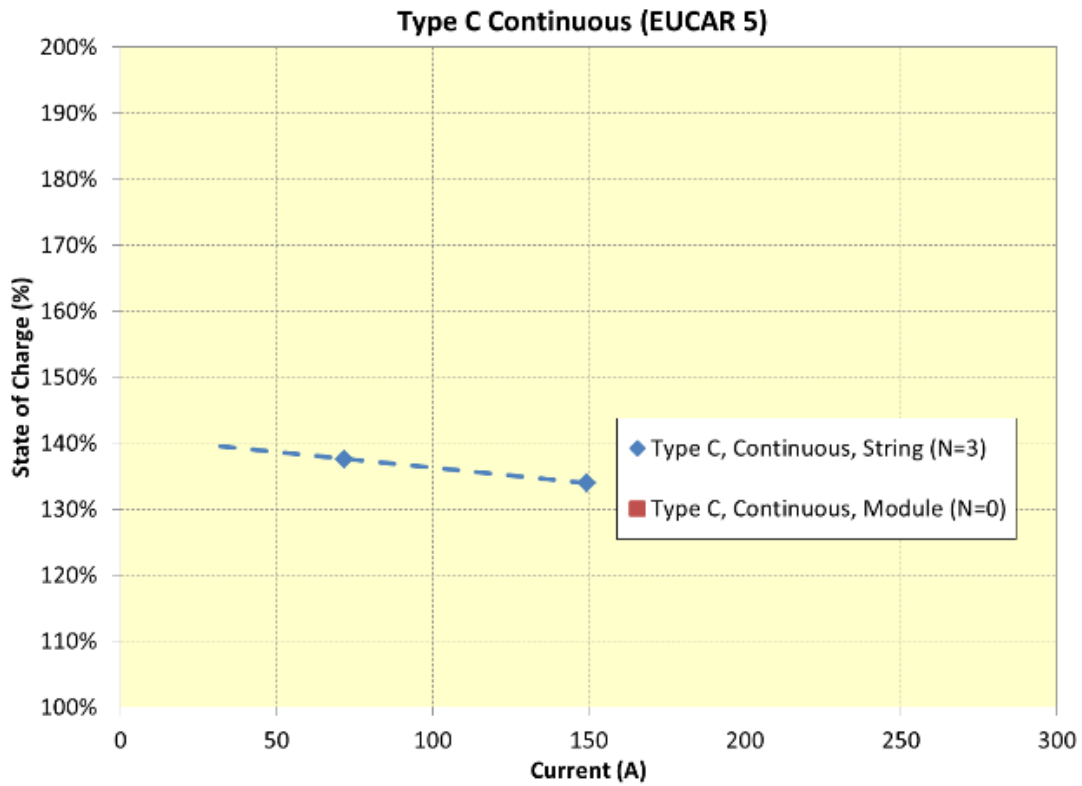
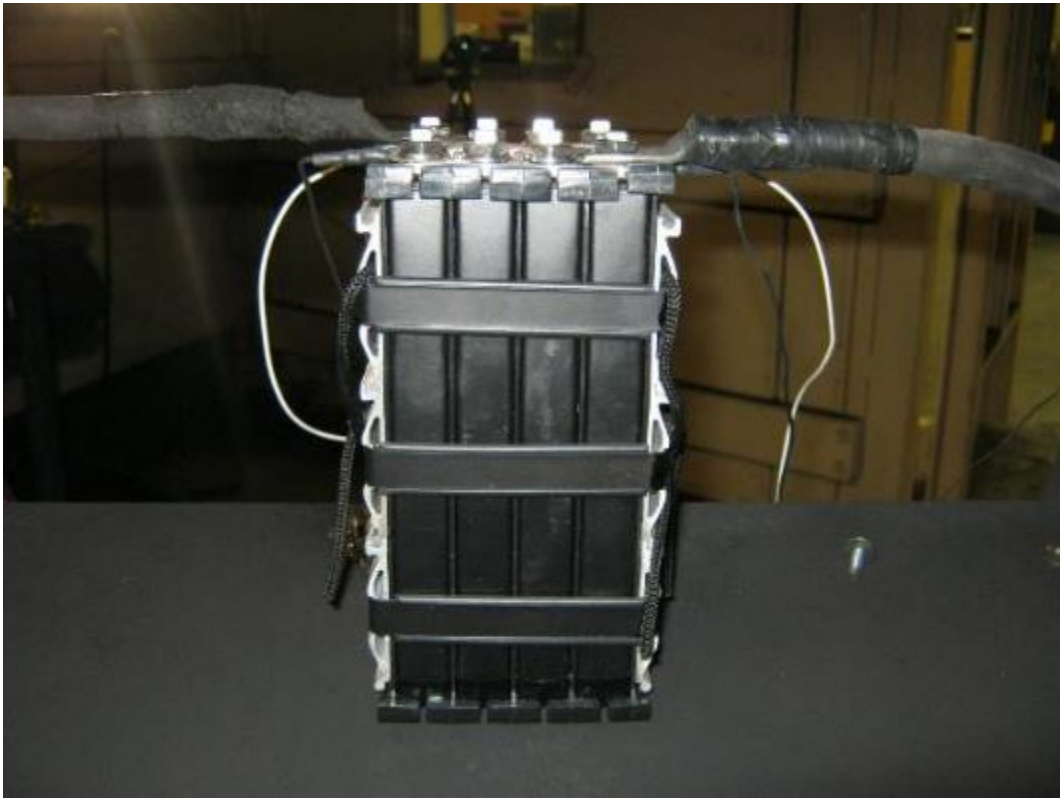
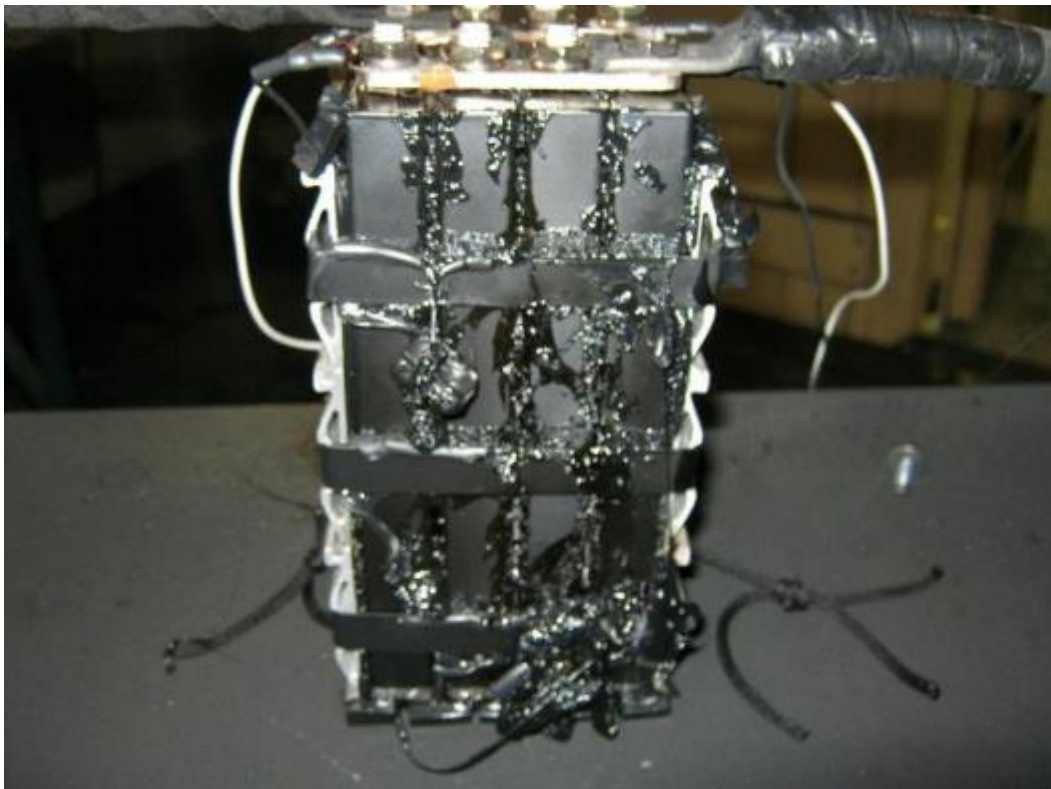


Figure 155 Type C Continuous (EUCAR 5)



**Figure 156 Continuous 149A String Type C Pre-Test Fixture (OC049)**



**Figure 157 Continuous 149A String Type C Post-Test Fixture (OC049)**

For the Type C start/stop condition, only two string level results were run. As was previously mentioned, these units were able to make it to 200 percent SOC without a EUCAR 5 result.

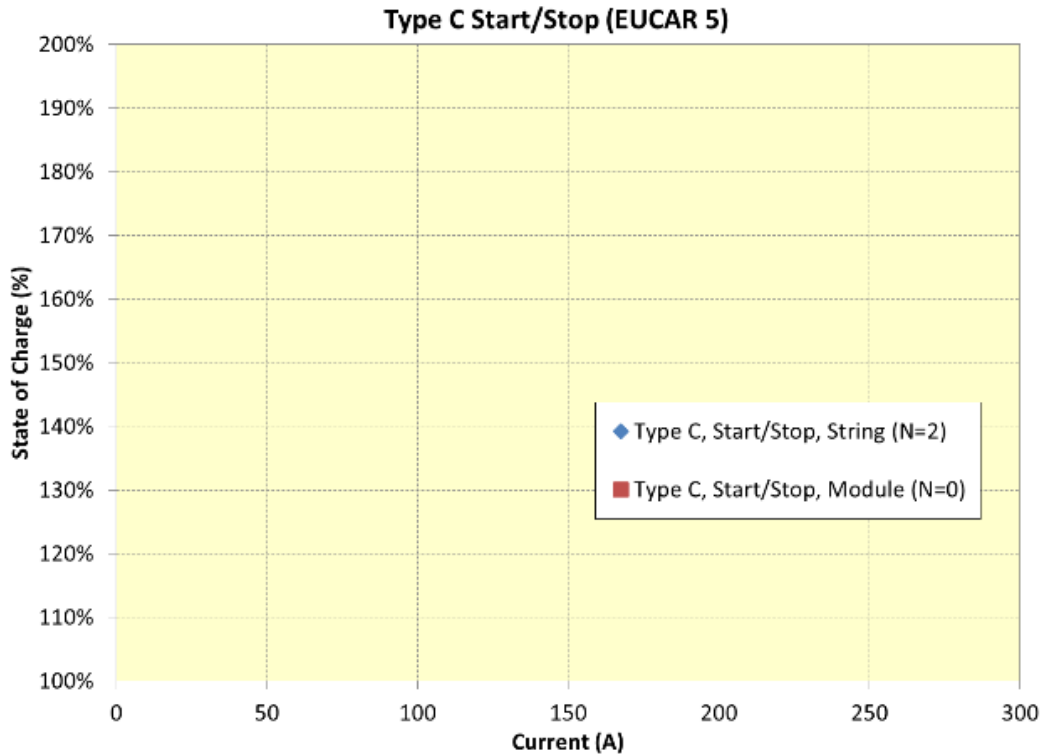


Figure 158 Type C Start/Stop (EUCAR 5)

## 10.7. Short Circuit analysis

The short circuit test plan focused on varying the relative resistance of applied shorts to different levels of hardware. Defining one resistance level for all testing, such as some test manuals do with 10mΩ as hard, could generate very different reactions from a hardware unit depending on its internal resistance. This variability was addressed by scaling of relative resistances that defined hard, medium and soft testing.

### 10.7.1. Short Circuit Summary

An analysis of the short circuit test focused on the electrical response (voltage and current) of a hardware to the short circuit and its corresponding EUCAR levels. A representative plot of a short circuit electrical response is shown in Figure 159.

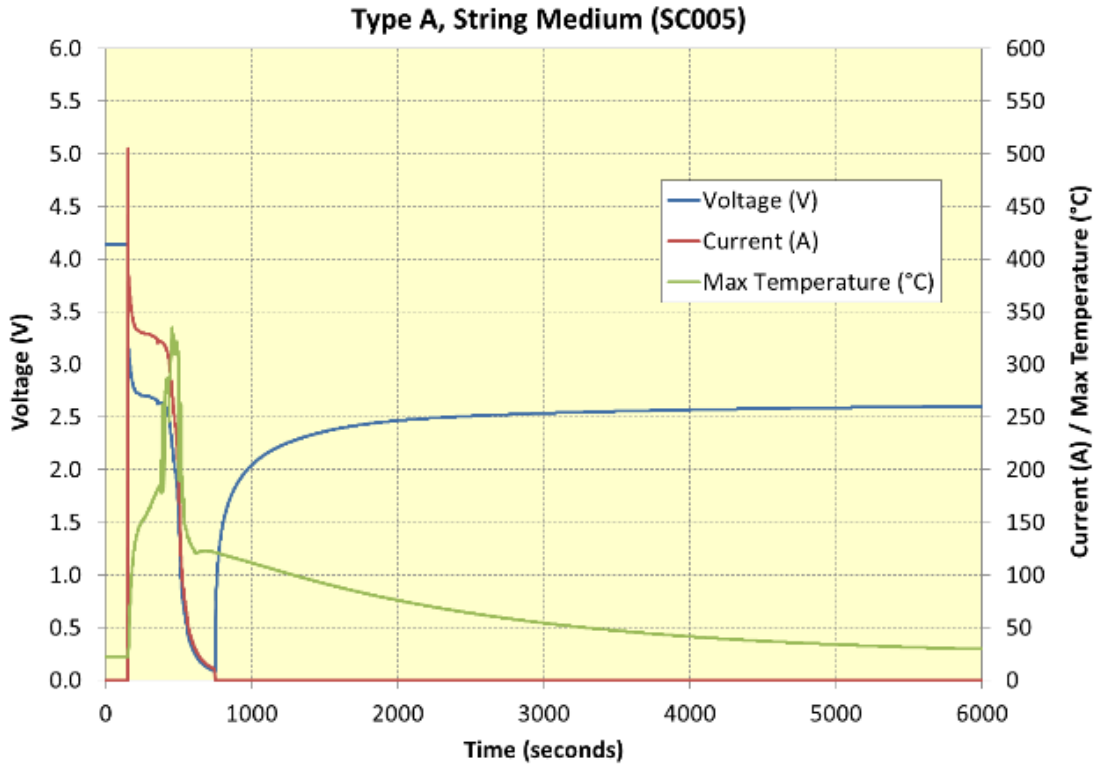


Figure 159 Electrical Response of Type A String Medium (SC005)

The results of this testing included 26 units and displays the characteristic hyperbolic relationship between current and resistance ratio that would be expected from a mechanism governed by Ohms law (see Figure 160). Due to the spread of responses, EUCAR 0-2, 3/4 and 5 reactions are plotted differently for clarity.

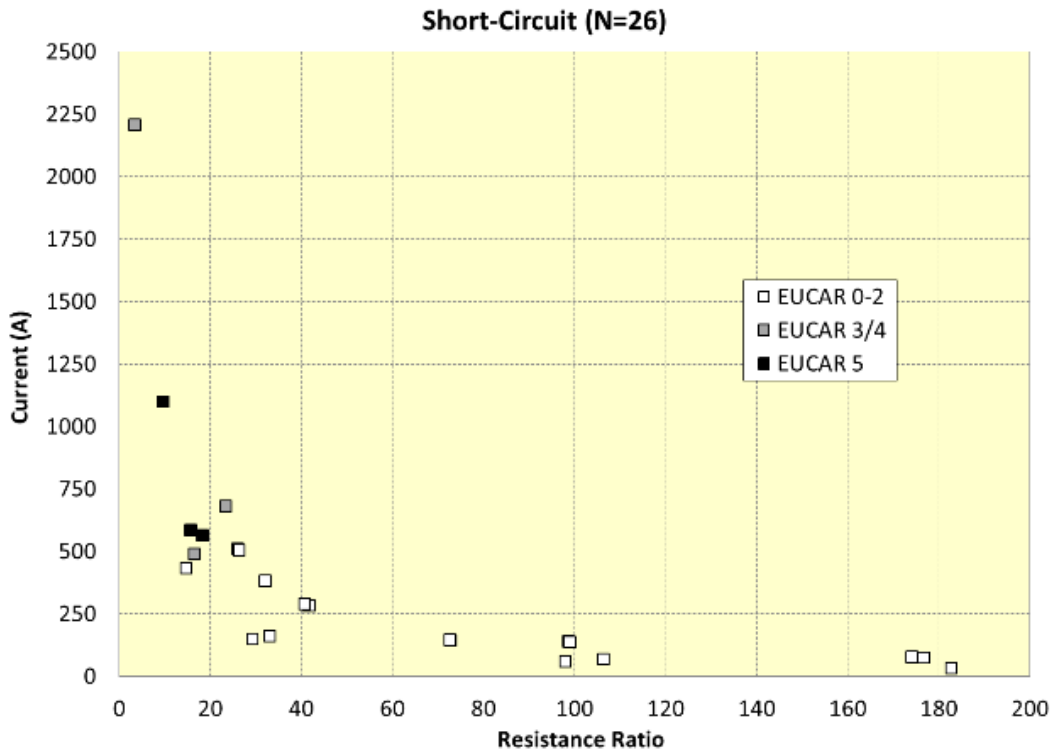


Figure 160 Short Circuit Analysis Data

A summary of the short circuit analysis data shows a clear trend and inverse relationship between current flow during a short and the resistance ratio of the applied shunt (see Figure 161). The color coding in this figure is the same as was described for Figure 44. At resistance ratios of greater than 18, no hardware experienced a EUCAR 5 and at ratios lower than 10, all did (with one exception show in Figure 160 which experience vaporized terminal tabs, thereby preventing the short from going to completion). Likewise current levels that yielded EUCAR 5s were in excess of 560As and without the one exception described previously, any currents above 1100As led to events.

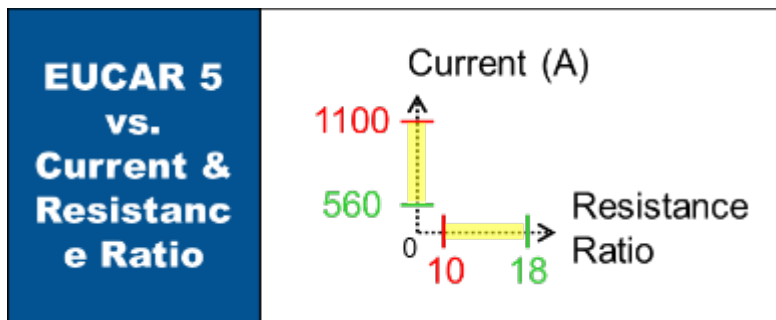


Figure 161 Short Circuit Analysis Summary



### 10.7.2. String

The short circuit string results are described in this section. Below is shown a side by side comparison of the electrical response (current) of the Type A, and C units under a variety of resistance ratios. The relationship between current and resistance is defined by ohms law and as such this plot shows the characteristic hyperbolic trend the inverse relationship produces.

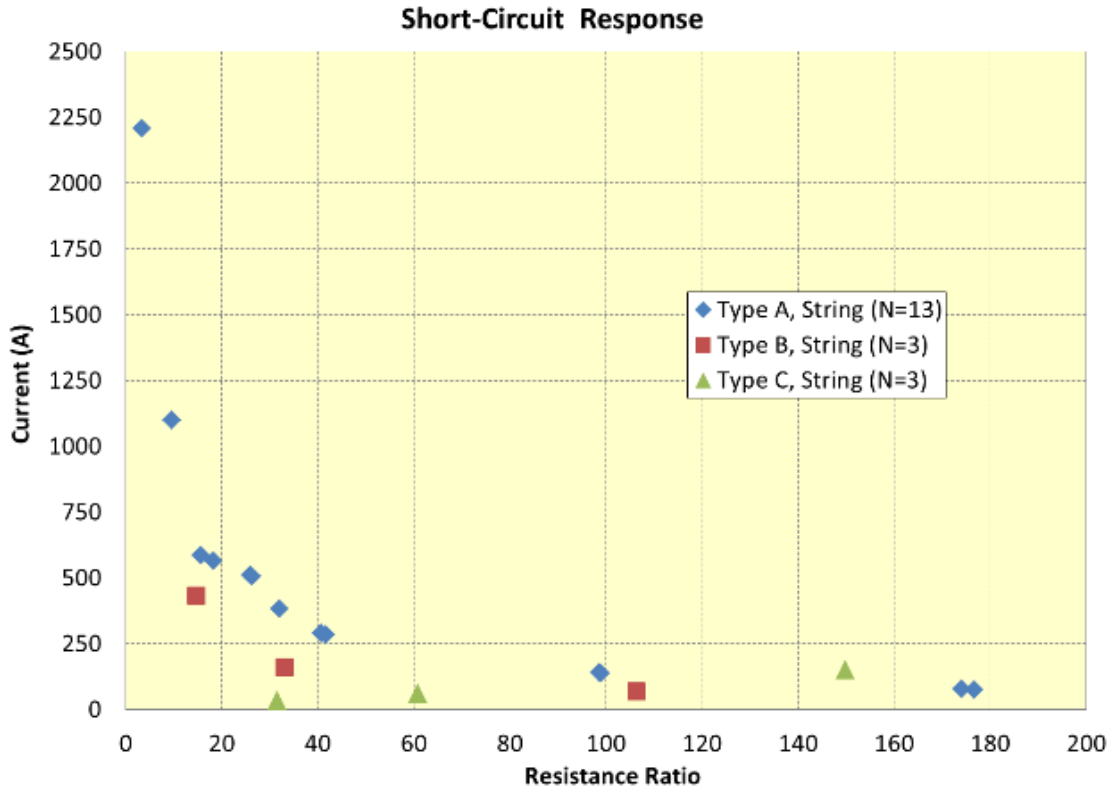


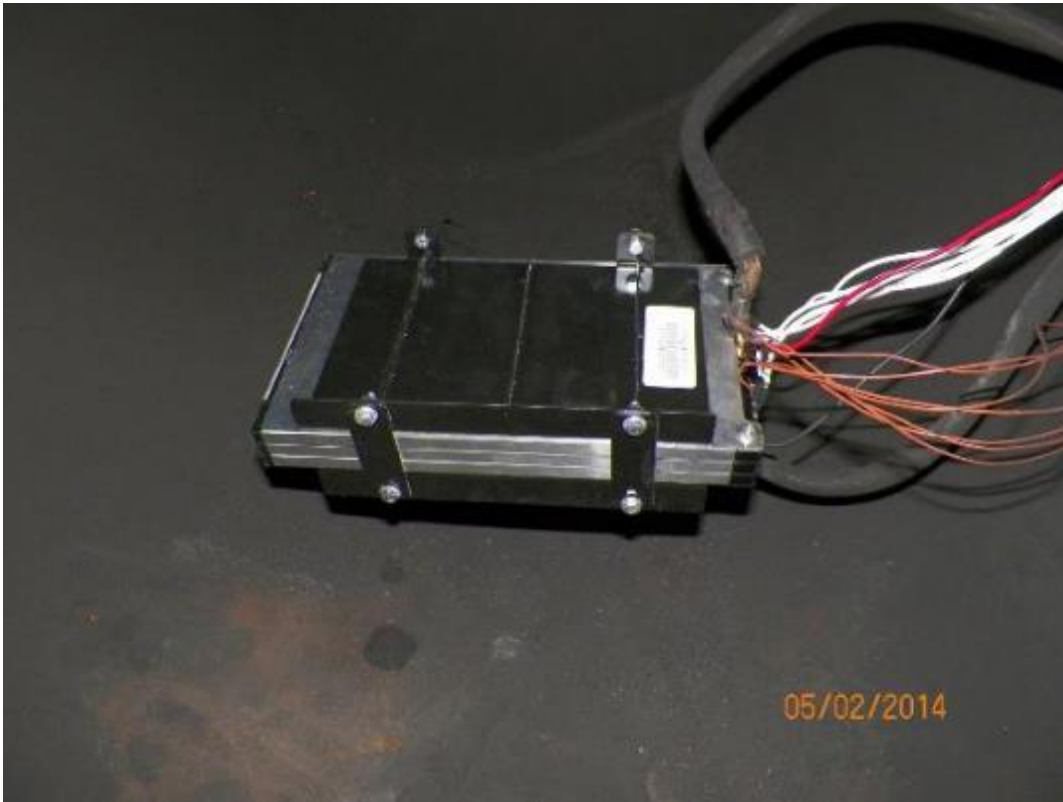
Figure 162 Short-Circuit Response, String



**Figure 163 Hard String Type A Pre-Test Fixture (SSHA01)**



**Figure 164 Hard String Type A Post-Test Fixture (SSHA01)**



**Figure 165 Hard String Type B Pre-Test Fixture (SSHB01)**



**Figure 166 Hard String Type B Post-Test Fixture (SSHB01)**

### 10.7.3. Module

Module short circuit test results are reviewed in this section. The Type A values broadly follow the same hyperbolic relationship between current and resistance. The Type B module was tested at a resistance ratio of ~1,000 due to testing challenges and although its current value tracks with the hyperbolic trend, its location would make this plot difficult to read if shown.

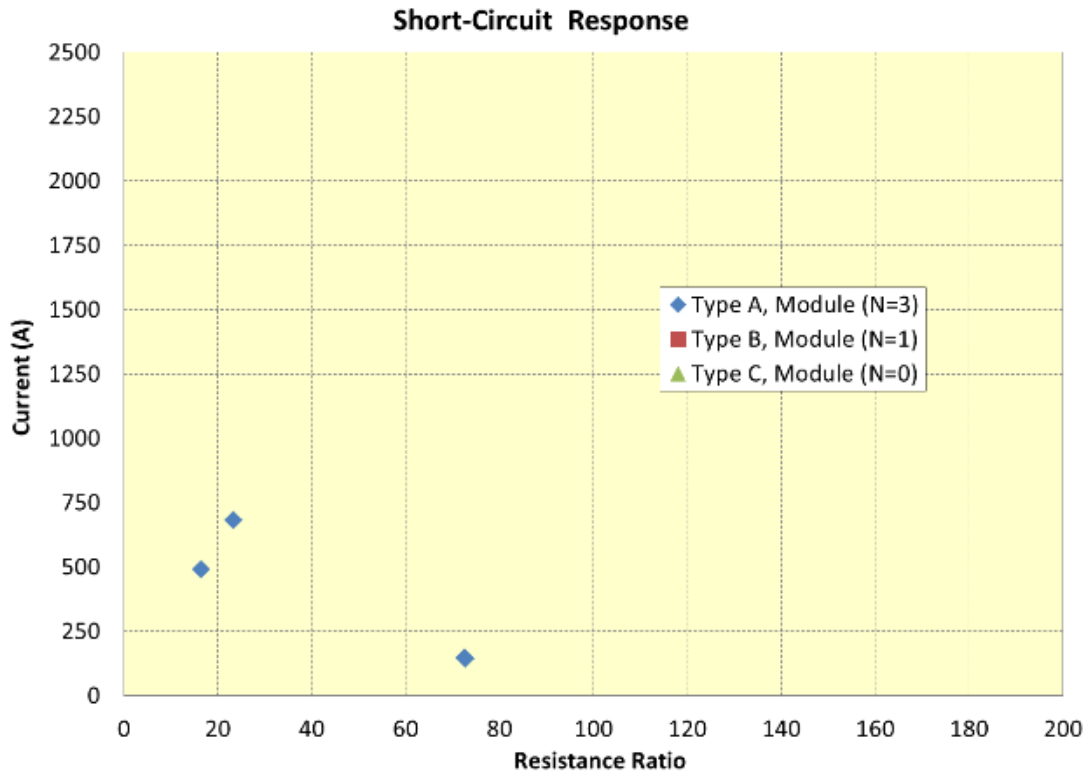
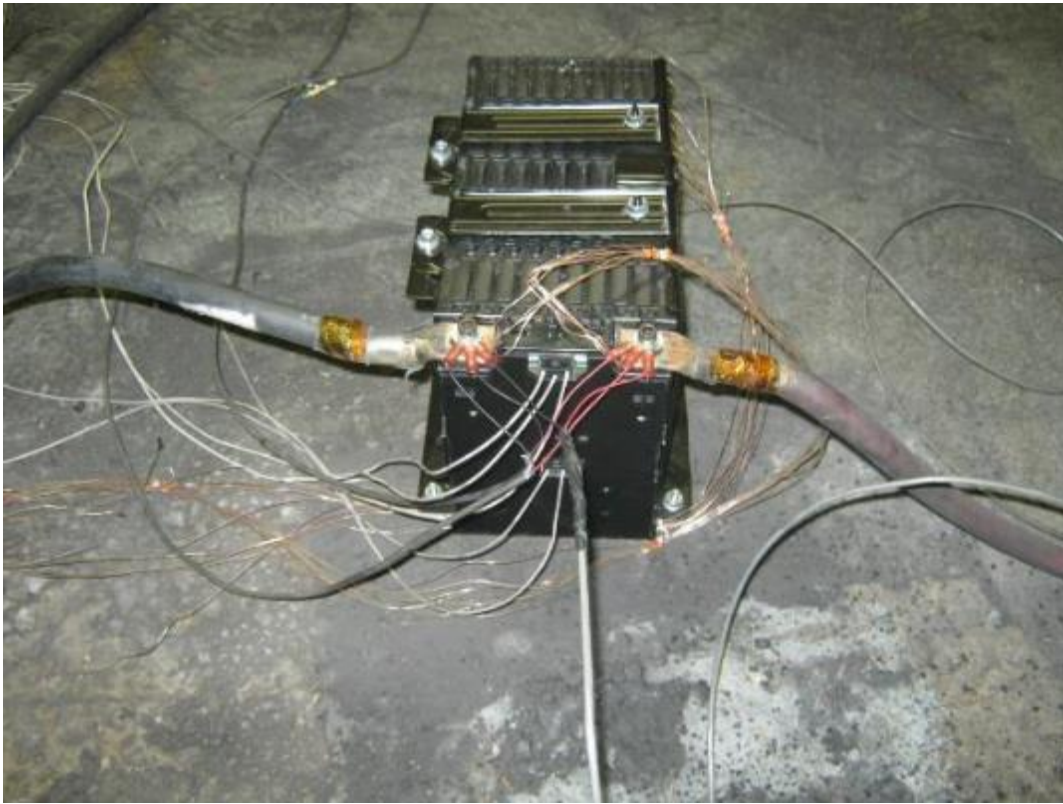


Figure 167 Short Circuit Response, Module



**Figure 168 Hard Module Type A Pre-Test Fixture (SC014)**



**Figure 169 Hard Module Type A Post-Test Fixture (SC014)**

### 10.7.4. Type A

This section compares the Type A string and module test results for the large range of relative resistances tested. This data set confirms that both the string and module level follow the hyperbolic trend when the applied short resistance is compared to the hardware's resistance itself.

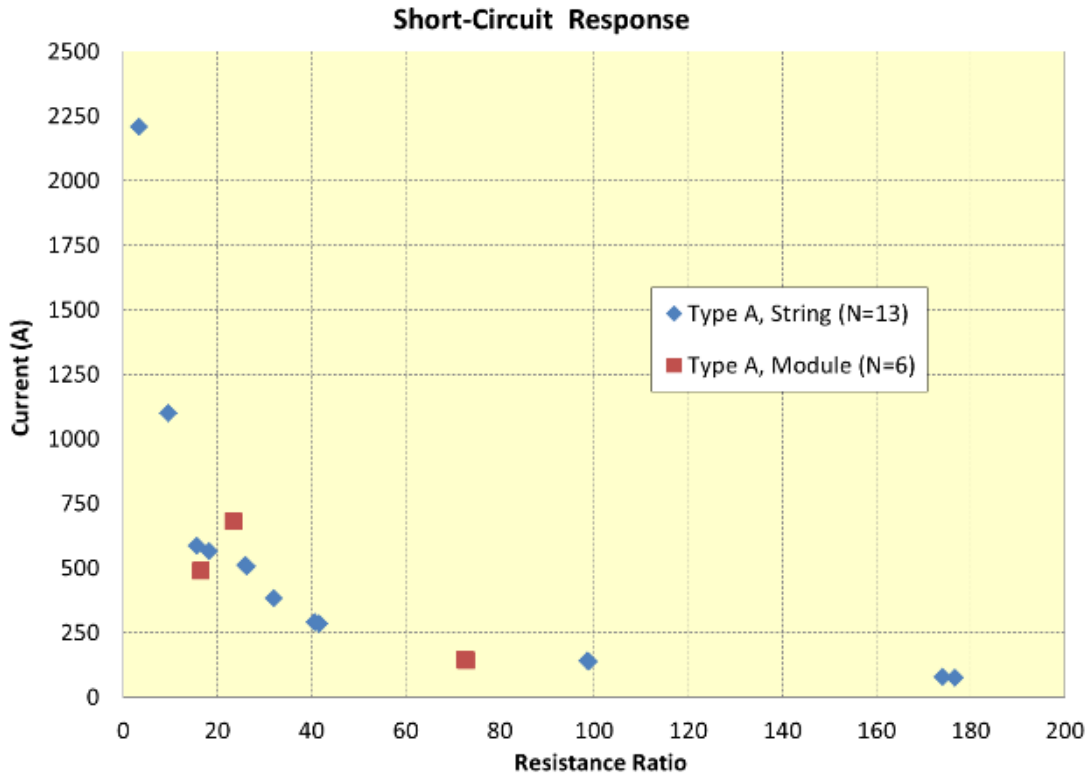
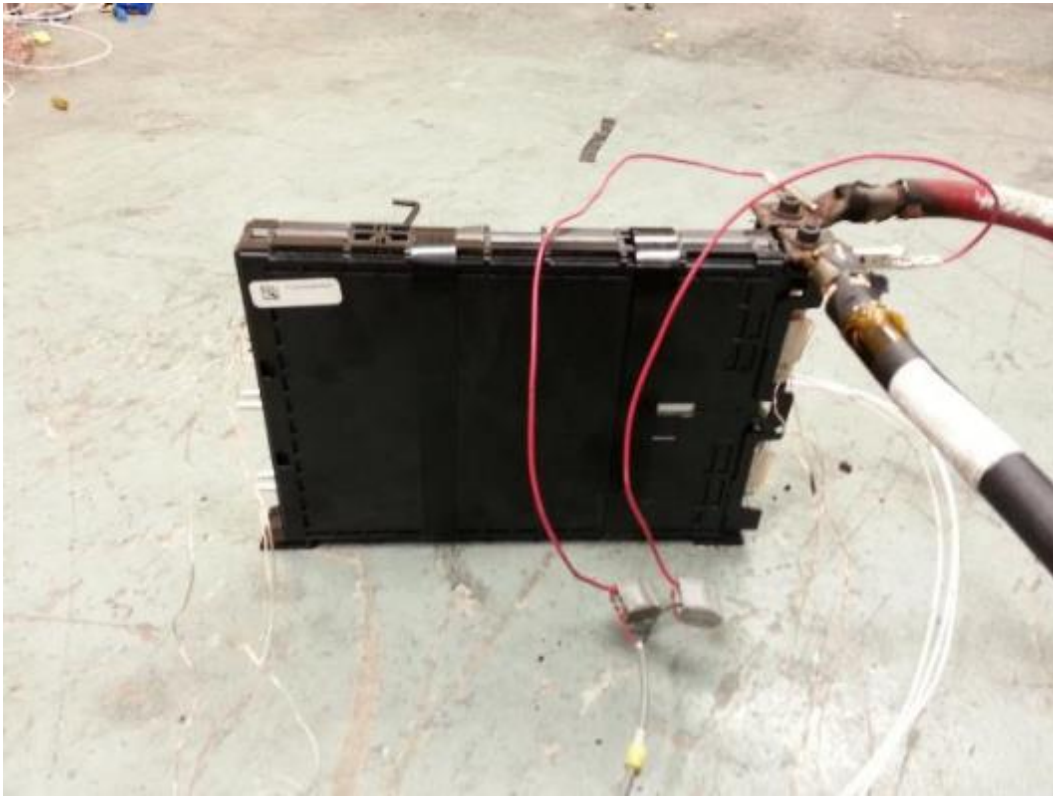
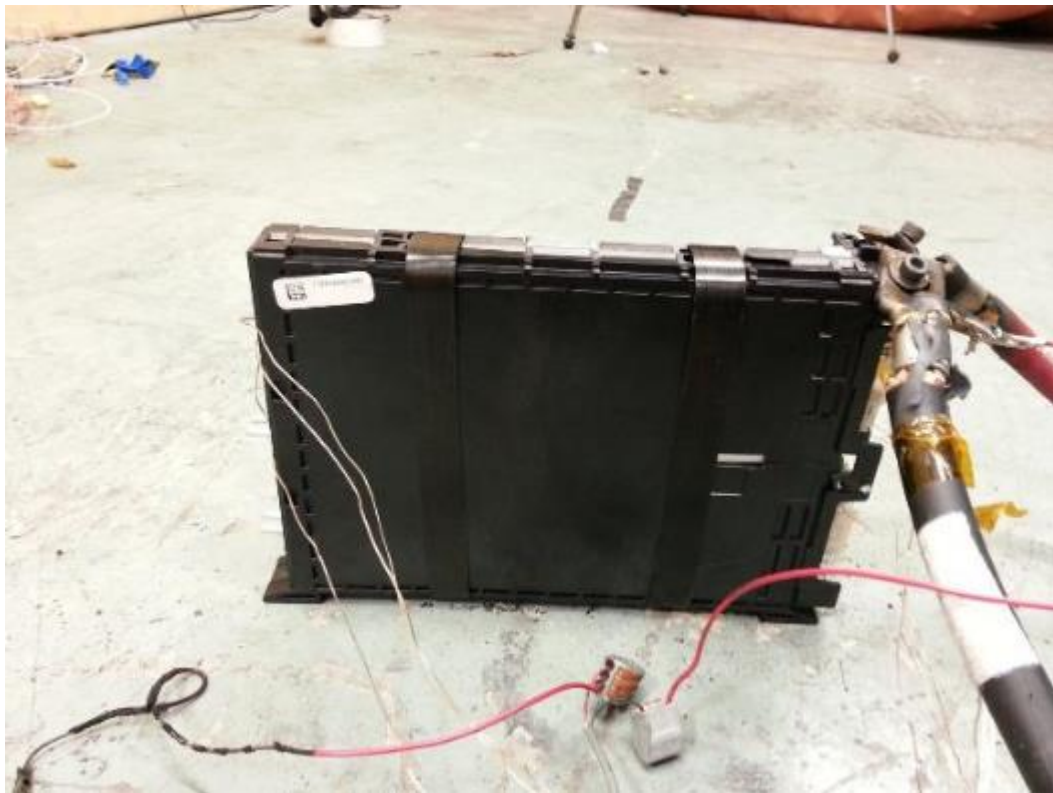


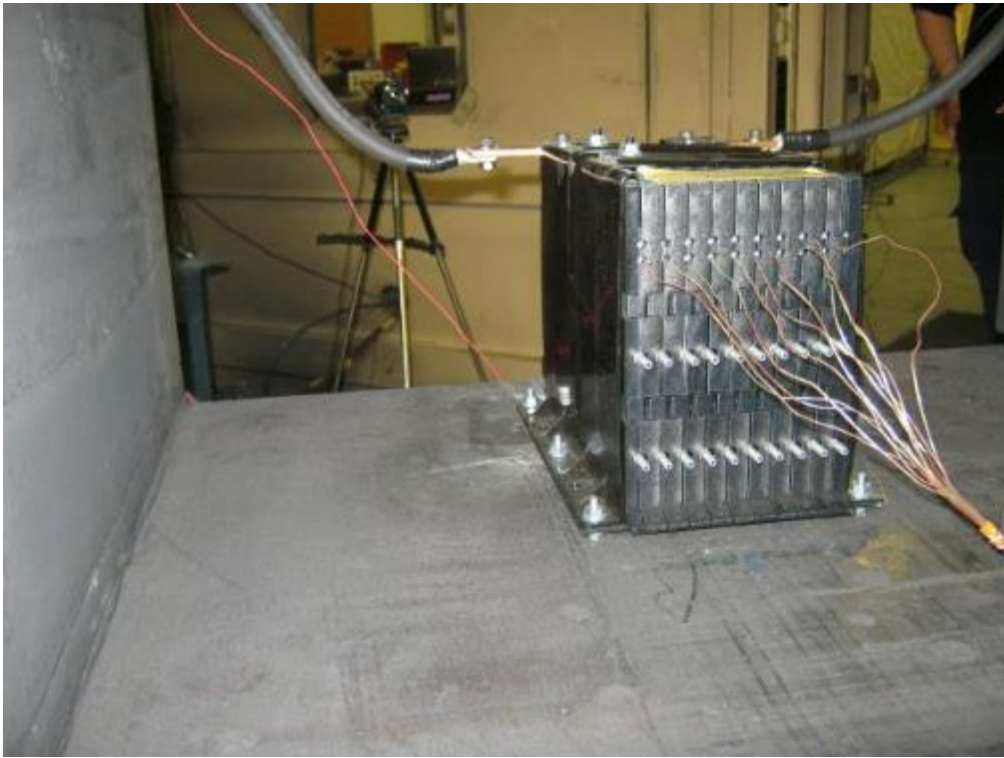
Figure 170 Short Circuit Response, Type A



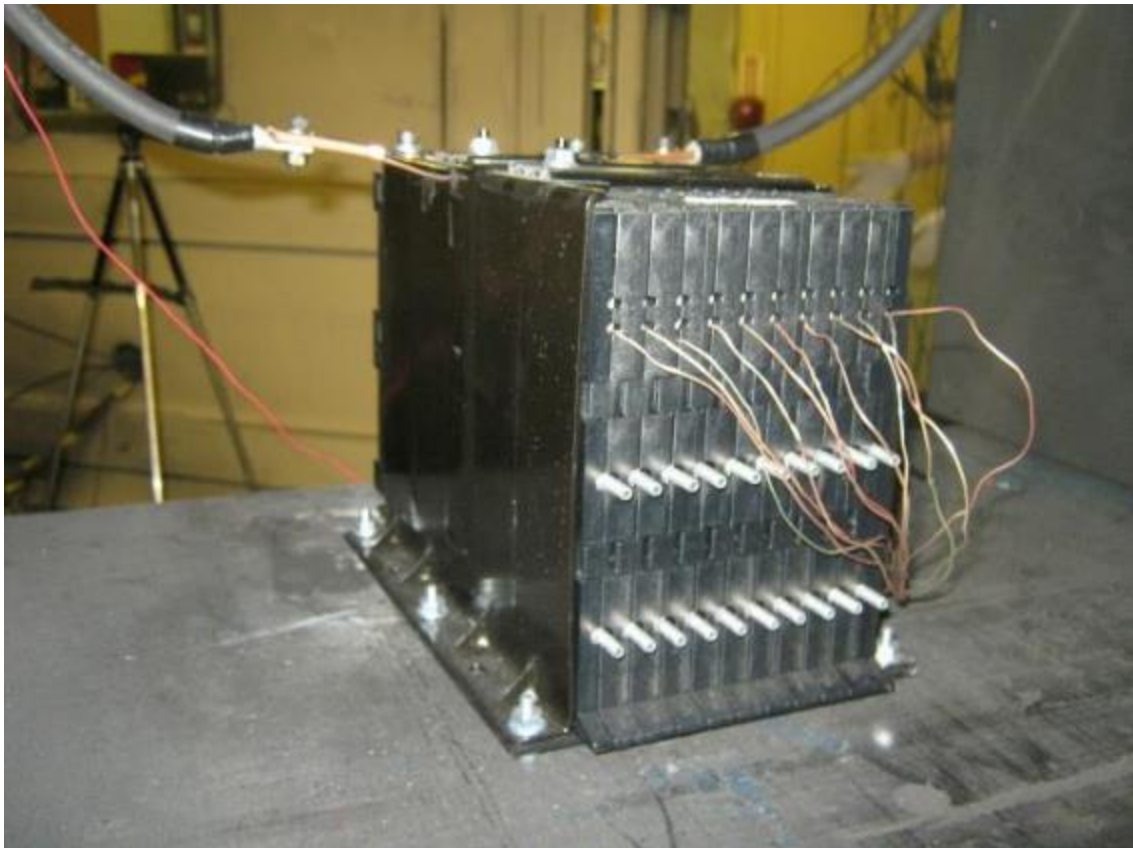
**Figure 171 Medium String Type A Pre-Test Fixture (SC004)**



**Figure 172 Medium String Type A Post-Test Fixture (SC004)**



**Figure 173 Medium Module Type A Pre-Test Fixture (SC017)**



**Figure 174 Medium Module Type A Post-Test Fixture (SC017)**



### 10.7.5. Type B

The Type B string and module data is compared in this section. As was mentioned previously, the Type B module relative resistance implemented was extremely large. Although this result fits the trend of hyperbolic relationships between current and resistance, its plotting falls out of the x-axis span by a significant margin. As reviewed before the Type B strings display the inverse relationship between current and resistance predicted at the project's onset.

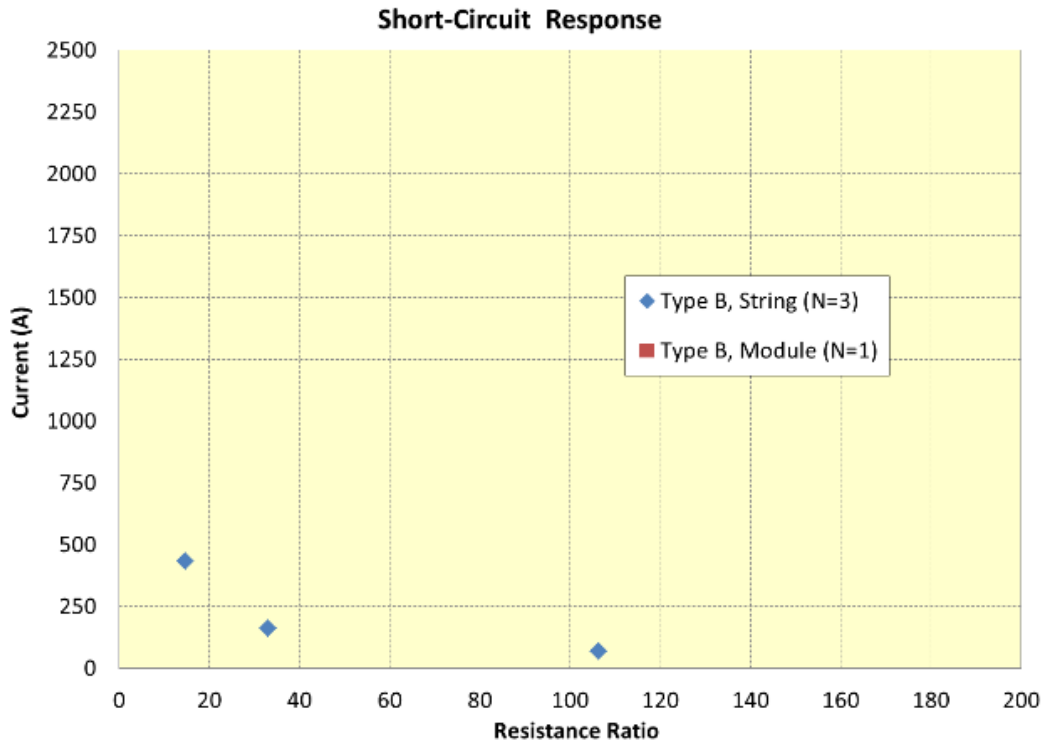


Figure 175 Short Circuit Response, Type B

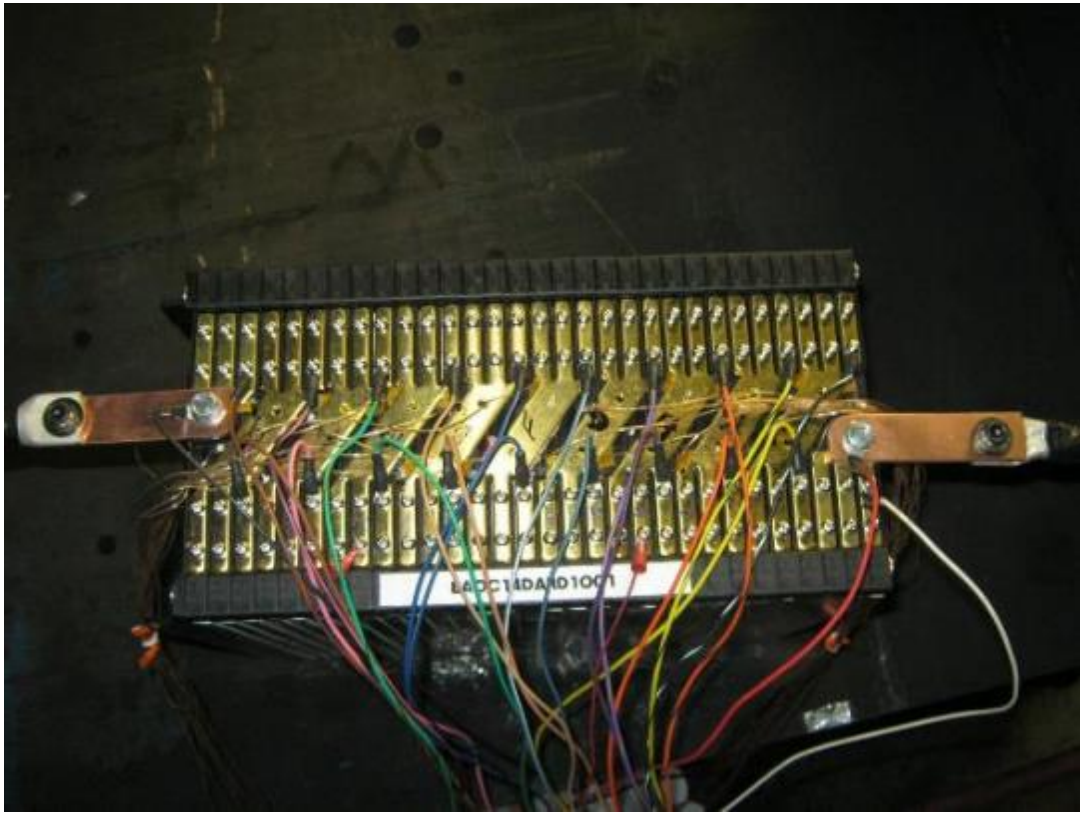


Figure 176 Hard Module Type B Pre-Test Fixture (SC016)

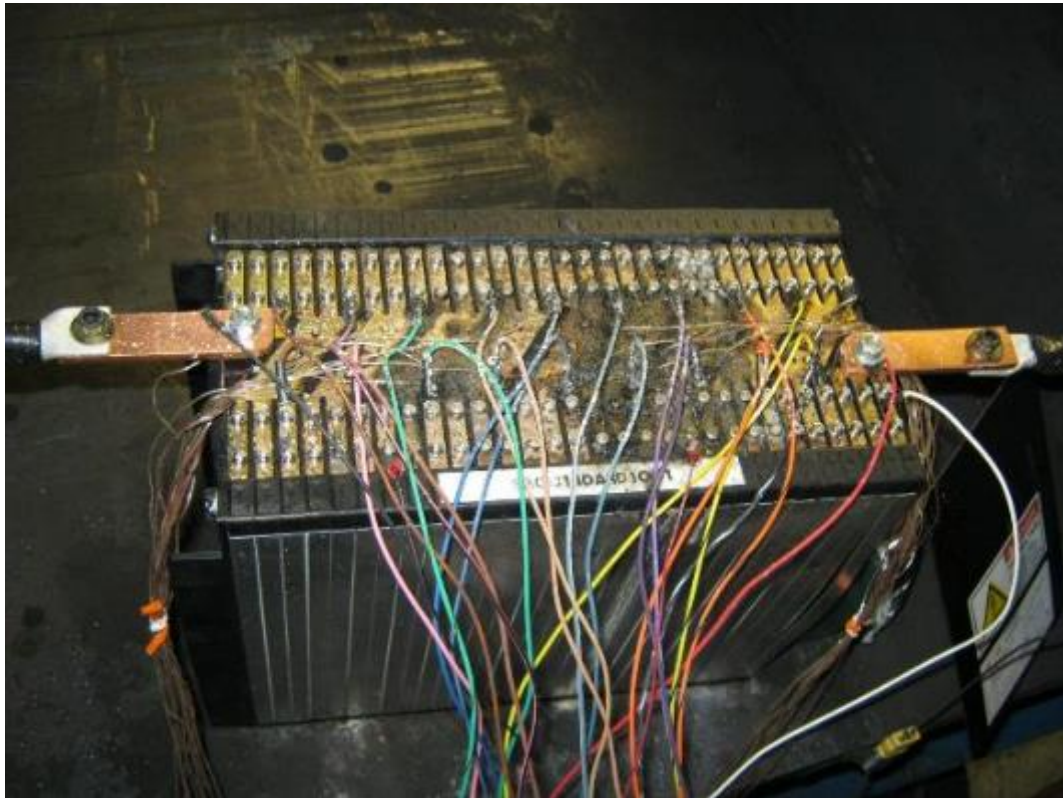


Figure 177 Hard Module Type B Post-Test Fixture (SC016)

## **11. Vehicle Level Procedural Development**

### **11.1. Approach**

The original approach of the team proposed in its solicitation response to NHTSA was implemented as planned during this program. The team performed an extensive fault tree analysis to document and considered all possible faults within the project scope. Following the assessment and prioritizing of faults, a review was made of existing test standards and regulations that pertained to the identified priority faults. The external documents and the team's experience were used to draft initial versions of test methods for each of the three priority faults, crush, overcharge and short circuit.

The developed test methods were then extensively tested at multiple test sites, on RESS hardware of varying size (weight, volume and energy content) and construction (manufacturer, packaging and chemistry). Over time, the testing experience led to an evolution and refinement of the parts test procedure as presented in this report. The test data was analyzed to develop test performance safety metrics and boundary conditions, as called for in the original solicitation and presented in section 10.

### **11.2. Recommended Procedures**

This section is in response to the original solicitation's request for recommended testing procedures. The project team focused on crush, overcharge and short circuit testing at the parts level. The rationale for this focus has been described throughout this report and summarized in section 11.1.

#### **11.2.1. Crush**

To create a vehicle level crush procedure recommendation, it is important to determine which features of parts level testing translate up in scale and which do not. Following a large amount of parts level testing, one consistent output was the ability to crush hardware to approximately 10 percent displacement without triggering a EUCAR 5 event (see Figure 44). This performance was seen in all hardware types, of all sizes, directions and quantity of crush steps. It was also consistently seen that the span of hardware responses increased as the test article became more difficult to fully engage in a crush. This can be seen in the tighter range of responses in the x-axis when compared to the y and z axes. To address this known challenge significant effort was expended in hardware design (retention bands) and test jig (platens, shaped rams and spacers).

This variability is inherent in the parts test process as the native vehicle enclosure is unavailable to provide the appropriate or real worlds level of physical confinement that a RESS would see in a crush. As a result, it is the project team's conclusion that crush parts testing would not be a suitable candidate for addition as vehicle level test procedure. However, it is also the team's rec-

ommendation that the test figure of merit (percent of RESS displacement) and boundary conditions displayed in Figure 44 would be useful to apply while reviewing the results of existing crash testing.

### **11.2.2. Overcharge**

The fault tree analysis (section 5) performed at this project's onset did not take into account the probability of specific events happening so as to remain parts/manufacturing quality neutral and consider all possibilities. This lack of consideration of probabilities, disregards the multiple battery controls that are often implemented to prevent an overcharge event from occurring. As a result overcharge as a potential fault was select as a priority issue given the possible severity of its occurrence.

During the course of the fault tree analysis, a lot of activity centered on the BMS functionality definition (section 5.4). Two feature sets, Basic (Figure 13) and Advanced (Figure 14), were the output of this activity. As a practical matter the vast majority of electrified vehicles more closely resemble the Advanced feature set than the Basic. Central to both sets is a voltage feedback loop over the contactor control that maintains the RESS isolation during non-use or in abnormal conditions. In order to achieve an uncontrolled overcharge it would be necessary to bypass all the controls built into both of the bookends (Basic and Advanced) of available BMS designs.

Notwithstanding the FTA and BMS analysis background described above, attempting to perform a vehicle level overcharge test using the manufacturer's designed charge port would be appropriate. This test would serve as a confirmation of compliance with the BMS functionality expectation described in section 5.4. In the unlikely event that a vehicle would allow an overcharge situation to begin, it is the recommendation of this project's team that the developed metrics and boundary conditions (Figure 116) be applied.

### **11.2.3. Short Circuit**

The short circuit behavior displayed by all hardware test units complied well with a predictable Ohms law relation once the relative resistances of the RESS and the applied short were taken into account. The propensity for energetic RESS responses also correlated very well with the current displayed during the shorts and the relative resistances. This high level of correlation would make it possible to predict a RESS's responses to a wide range of external short circuit events. This predictability obviates the need for a new test in the project team's viewpoint. Rather by providing an analysis of the RESS resistances and fusing system, it would be possible to determine whether a RESS design has the ability to generate a severe response to a hard external short circuit.

## 12. Conclusion

This test program sought to study the current state of the art in lithium ion battery based RESS for new and untested safety hazards as prescribed by NHTSA’s solicitation. By following the original project approach and method (see Figure 178) of an FTA, standards review and testing iterations, three sets of well-defined faults were identified and tested. These three procedures, as well as lessons learned through the project, are included as standalone sections in the appendix of this report.

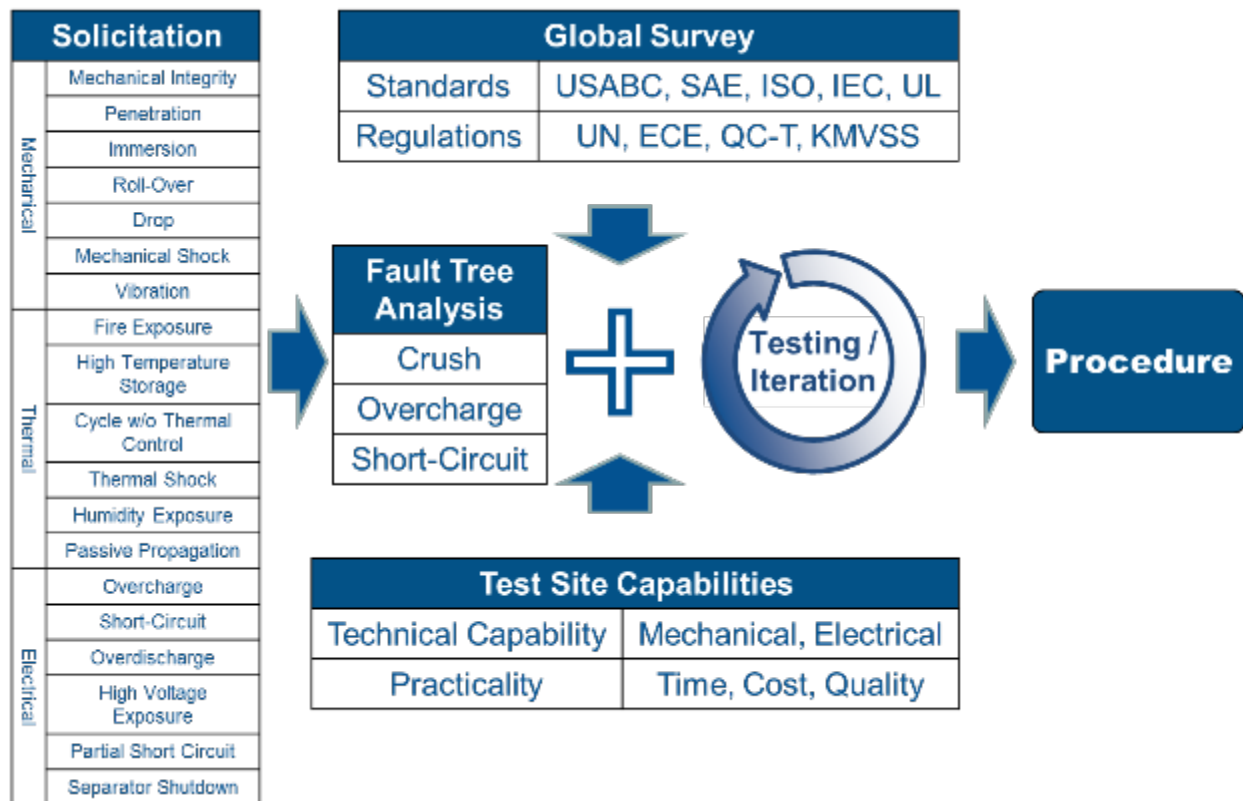


Figure 178 Summary of Project Approach and Method

The resulting experimentation led to new insights, performance metrics and boundary conditions for each of the identified faults. Analysis of this data formed the basis for a vehicle level procedure recommendation in line with NHTSA’s original request.

## **Appendix A: Battery Abuse Crush Test Procedure**

## **Battery Abuse Crush Test Procedure**

### **1. PURPOSE**

Electric propulsion in a hybrid electric vehicle (HEV), plug-in hybrid electric vehicle (PHEV) and electric vehicle (EV) platform relies on rechargeable energy storage systems, commonly referred to as batteries. However, the automotive application and use of a RESS, such as a lithium-ion (Li-ion) based battery system, poses certain potential risks to vehicle operators and occupants that are different than those associated with an internal combustion engine. The purpose of this test procedure is to assess the reaction of batteries and battery subsystems under various crush scenarios using uniform test methods that are designed to provide consistency in data acquisition and performance between test laboratory sites.

### **2. SCOPE**

This test procedure is designed to collect data from a battery or its subsystems when mechanically deformed by a ram with a prescribed form factor. Three load patterns are provided for optimized identification of important events and for production of comparative data. As necessary for a specific design, ancillary fixtures may be required to hold the test sample in its proper orientation during the crushing movement of the ram. Although the intent of this procedure is to evaluate the RESS response to a crush condition, it can also be applied to cells, cell strings, and modules, to more thoroughly identify failure mechanisms and propagation effects.

### **3. REFERENCES**

#### **3.1 Applicable Publications**

N/A

#### **3.2 Related Publications**

The following publications are provided for information purposes only and are not a required part of this document.

##### **3.2.1 SNL Publications**

Available from Sandia National Laboratories, [www.sandia.gov](http://www.sandia.gov)

- SAND2005-3123 FreedomCAR Electrical Energy Storage System Abuse Test Manual for Electric and Hybrid Electric Vehicle Applications

### 3.2.2 SAE Publications

Available from SAE International, [www.sae.org](http://www.sae.org)

- SAE J1715, Hybrid Electric Vehicle (HEV) and Electric Vehicle (EV) Terminology
- SAE J2464, Electric and Hybrid Electric Vehicle Rechargeable Energy Storage System (RESS) Safety and Abuse Testing
- SAE J2929, Electric and Hybrid Vehicle Propulsion System Safety Standard – Lithium-Based Rechargeable Cells

### 3.2.3 ISO Publications

Available from International Standards Organization (ISO), [www.iso.org](http://www.iso.org)

- ISO 12405-4 Electrically propelled road vehicles – Test specification for lithium-ion traction battery packs and systems – Part 4: Performance testing
- ISO 12405-3 Electrically propelled road vehicles – Test specification for lithium-ion traction battery packs and systems – Part 3: Safety performance requirements

### 3.2.4 United Nations Publications

Available from United Nations Economic Commission for Europe, [www.unece.org](http://www.unece.org)

- Recommendations on the Transport of Dangerous Goods, Manual of Tests and Criteria, 5th Revised Edition, 2011, Section 38.3, “Lithium metal and lithium ion batteries”
- Regulation No. 100 – Rev.2, Addenda to the 1958 Agreement ECE R100, 2013, “Uniform provisions concerning the approval of vehicles with regard to specific requirements for the electric power train”

## 4. DEFINITIONS

Except as noted below, all definitions are in accordance with SAE J1715.

### Battery

A device comprising one or more individual electrochemical cells connected in series and/or in parallel or modules packaged together with associated protection electronics and mechanical enclosure.



### Battery Cell (Cell)

The basic electrochemical unit of a battery, containing an anode and cathode, electrolyte, and typically separator. A cell is a self-contained energy storage and conversion device whose function is to deliver electrical energy to an external circuit. Energy is stored within the cell as chemical energy.

### Battery Cell String (String)

A group of interconnected cells into a common mechanical and electrical unit (i.e., a series and/or parallel configuration). Although similar, a string is smaller than a battery module.

### Battery Module

A group of interconnected cells in a single mechanical and electrical unit that is a subassembly of a full battery.

### Device Under Test (DUT)

A device that is subjected to the performance testing requirements defined herein. For the crush test procedure, the DUT can consist of cells, cell strings, modules, or RESSs.

### Emergency Response Guide (ERG)

A document describing the hazards that may be encountered during an emergency response operation involving an “article.” The Occupational Safety and Health Administration (OSHA) has defined “article” as a manufactured item other than a fluid or particle; (i) that is formed to a specific shape or design during manufacture; (ii) which has end use functions dependent in whole or in part on its shape or design during end use; and (iii) which under normal conditions of use does not release more than very small quantities (e.g., minute or trace amounts) of a hazardous chemical, and does not pose a physical hazard or health risk to employees.

### EV: Electric Vehicle

An automobile type vehicle, powered by an electric motor that draws energy solely from a rechargeable energy storage device.

### Fixture

A mechanical assembly surrounding the DUT and parallel with the motion of the platen that is designed to keep the DUT engaged during a crush event. The fixture may or may not be necessary depending on the mechanical stability of the DUT.

### Hazard Severity level (HSL)

A rating system that categorizes the severity level of a RESS reaction to abuse conditions. This procedure uses the European Council for Automotive Research and Development (EUCAR) rating system.

### HEV: Hybrid Electric Vehicle

An automobile type vehicle, powered by an internal combustion engine and an electric motor that draws stored energy from a rechargeable energy storage device for power assist.

### Lithium-Ion (Li-ion)

The term lithium-ion or Li-ion refers to an entire family of battery chemistries where the negative electrode (anode) and positive electrode (cathode) materials serve as a host for the lithium ion ( $\text{Li}^+$ ). Lithium ions move from the anode to the cathode during discharge and are intercalated into (i.e., inserted into voids in the crystallographic structure of) or otherwise react with the cathode. The ions reverse direction during charging and are intercalated into the anode material.

### Material Safety Data Sheet (MSDS)

A document that contains information on the potential hazards (health, fire, reactivity and environmental) of a chemical product.

### Personal Protective Equipment (PPE)

Clothing, helmets, goggles, or other garments or equipment designed to protect the wearer's body from injury.

### PHEV: Plug-in Hybrid Electric Vehicle

A hybrid vehicle with the ability to store and use off-board electrical energy in a rechargeable energy storage device. A range extended EV is a type of PHEV.

### Platen

A device that is made of machine steel or a similarly strong material that is used to crush the DUT.

### Rechargeable Energy Storage System

The RESS is a completely functional energy storage system consisting of a battery pack, necessary ancillary subsystems for physical support and enclosure, thermal management and control, and electronic systems control.

### State-of-Charge

The discharge capacity in ampere-hours of a battery, expressed as a percentage of the battery ampere-hour capacity.

### Thermal Runaway

Thermal runaway refers to rapid self-heating of a battery cell derived from the exothermic chemical reaction of the highly oxidizing positive electrode and the highly reducing negative electrode. It can occur with batteries of almost any chemistry. In a thermal runaway reaction, a cell rapidly releases its stored energy. At the end of a thermal runaway reaction, no electrical energy will be stored within the cell. Note that a measurement of 0 V at cell terminals alone is not evidence of thermal runaway. The cell may also have vented electrolyte, undergone a variety of irreversible chemical reactions, or have melted or burned components or activated internal protection mechanisms.

### Venting

The release of excessive internal pressure from a RESS cell, module, or battery pack in a manner intended by design to preclude rupture or explosion.

## **5. GENERAL TEST REQUIREMENTS**

### **5.1 General Precautions**

- 5.1.1 Conducting crush testing on any cell chemistry is potentially hazardous. A battery of any size (cell, cell string, module, and RESS) can emit flammable or toxic vapors, become very hot, ignite, eject corrosive or toxic liquids, or undergo an energetic disassembly.
  - 5.1.1.1 Prior to conducting crush testing, the individuals conducting testing should become familiar with the contents of a battery or cell and the related potential hazards; appropriate personal protective equipment (PPE) should also be assembled. A Material Safety Data Sheet (MSDS) or Emergency Response Guide (ERG) may provide relevant information.
  - 5.1.1.2 Testing should be conducted in a well-ventilated environment with provisions to mitigate smoke, flammable vapors, or toxic vapors. Should an air scrubbing system be used, the system filters should be selected as appropriate for the specific cell chemistry. System filters should be protected from ignition if emitted gas could be heated, is flammable, or a spark emission is expected. If testing will be conducted in open air, the testing agency should secure necessary burn permits.
  - 5.1.1.3 If emission of flammable gases is possible, the testing facility should be prepared to mitigate the hazards of an unintentional ignition. Potential methods of mitigation

include flammable gas monitoring, capability to remotely activate appropriate fire suppression systems, and high-volume vapor dilution systems.

- 5.1.1.4 Personnel conducting testing should be equipped with appropriate PPE such as a respirator with appropriate cartridges or Self-Contained Breathing Apparatus (SCBA), eye protection (safety glasses, goggles, or face shield), chemical resistant gloves, high voltage resistant gloves, high temperature resistant gloves, and flame or chemical resistant clothing (e.g., Nomex coveralls, turn-out gear, etc.). The testing agency should determine appropriate PPE prior to beginning of testing.
- 5.1.1.5 Personnel conducting testing should be separated from contact with ejected liquids or debris. This may include use of testing chamber, a testing enclosure, or designation of a minimum safe distance to the test article.
- 5.1.1.6 Personnel should be aware that test components can achieve high temperatures and can pose a burn hazard.
- 5.1.2 Batteries damaged by crush testing may present a potential high voltage electrical shock hazard. Test personnel should have appropriate PPE when approaching damaged batteries.
- 5.1.3 Test personnel shall use nonconductive or insulated tooling when working with the DUT.
- 5.1.4 Battery systems and test fixtures can be heavy and may require lifting. Removal after testing may pose additional difficulties (see Section 5.1.6).
- 5.1.5 Battery terminals should remain isolated until testing is ready to begin to avoid inadvertent shorting.
- 5.1.6 After testing has concluded, test articles may be damaged and pose a hazard during test cleanup. Stranded energy should be considered during post-test conditions and before battery disposal. Post-test isolation maybe also be compromised. Prior to handling conductive surfaces, the system shall be checked for isolation faults. Appropriate PPE might include Tyvek and respirators for post-test cleanup, depending on the facility requirements and battery chemistry. Post-test damaged terminals may not reliably indicate the total energy left in a battery. The testing agency should develop a plan for handling and disposing of damaged test articles.

## **5.2 Test Specific Precautions**

- 5.2.1 Crush testing may cause energetic reactions including toxic gas discharge, particulate generation, smoke and fire. Laboratories must be prepared to accommodate deleterious events associated with these procedures.

- 5.2.2 Mechanical crush testing involves using very high forces. Available precautions specific to the equipment used shall be followed. Crush, pinch and leakage of hydraulic fluid (for a hydraulic system) are possible hazards.
- 5.2.3 Testing equipment should be located in an area with isolating walls that can contain any flying debris and vents any gaseous discharge away from test personnel.
- 5.2.4 Criteria for the safe approach of a battery after crush testing should be considered before re-entry into the test area (e.g., allowing sufficient time for ventilation and temperature cooling).
- 5.2.5 Cleanup and disposal should follow industrial hygiene guidelines including proper PPE to be worn during this process.
- 5.2.6 A sparker shall not be used unless required by the specific test facility and/or a significant DUT vent occurs.

### **5.3 Safety Requirements**

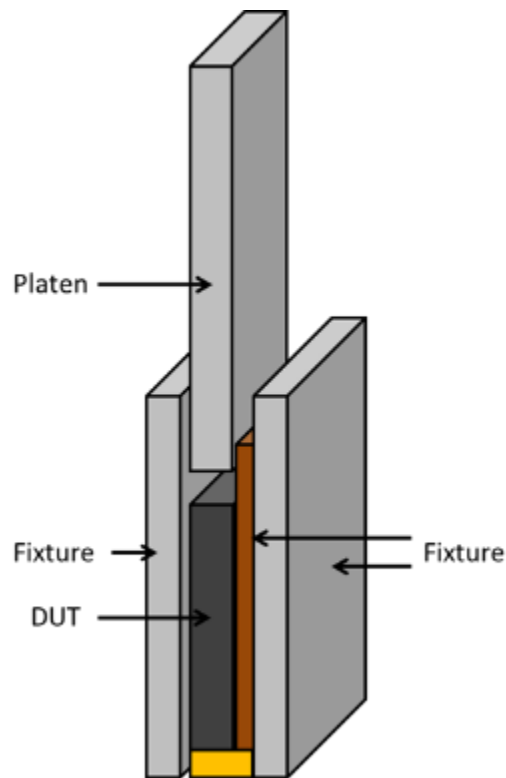
- 5.3.1 The testing agency must develop a specific safety plan for each crush test, including a list of required PPE. This safety plan should be based on information provided by the manufacturer regarding DUT chemistry and system architecture as well as precautions typically associated with high voltage systems. See discussion in Sections 5.1 and 5.2.

### **5.4 Test Facility/ Equipment Requirements**

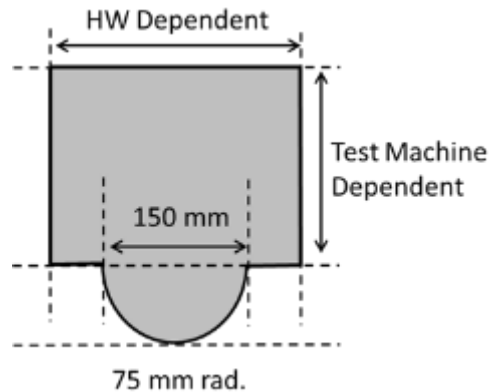
- 5.4.1 Facility and equipment requirements for crush testing:
  - 5.4.1.1 The facility must have appropriate PPE such as respirators, safety glasses, and high voltage gloves. See discussion in Sections 5.1 and 5.2.
  - 5.4.1.2 The facility must have a thermal chamber or temperature-controlled area for thermally soaking the DUT to a temperature of  $25\pm 3^{\circ}\text{C}$  (see Section 6.4).
  - 5.4.1.3 If necessary, the facility must be equipped with an appropriate fixture for holding test samples while linear crush loads are applied. It should be insulated to prevent the development of new short-circuiting conduction paths during the crush tests.

A fixture design example is shown in Figure 1, where the DUT is a single cell oriented in the Y-axis (see Section 6.3.4). The fixture consists of two plates that are secured in the appropriate orientation to hold the DUT during the crush test. Note that the DUT may move as the platen displacement increases during crush testing. Where necessary, bands or other specially designed fixtures may also be required to keep DUTs properly oriented during a crush event.

- 5.4.1.4 The facility must have suitably-sized crush equipment that is made of machine steel or a similarly strong material. It should not reach its physical maximum load limit during testing. Its minimum load capability should exceed 1,000 times the DUT weight, up to a maximum of 100 kg and 980 kN. The available crush speed shall be 5 mm/second.
- 5.4.1.5 The crush equipment platen shall be sufficiently wide to fully engage the DUT during crush testing. The width shall be a maximum of 25.4 mm thick. The platen shall also include a single hemisphere on the tip as shown in Figure 2. The hemisphere radius shall be a maximum of 75 mm or at least in excess of the DUT width that is to be crushed. The platen shall be controllable in at least 5 percent displacement increments. The height of the ram should be tall enough to achieve at least 85 percent displacement for the DUT.



*Figure A-1 – Crush fixture example; the fixture plates and platen are shown in gray, a spacer is shown in brown, and the DUT is shown in dark gray with a gold bus bar.*



**Figure A-2 – Crush platen example; the platen width and height are dependent on the DUT size and crush fixture.**

- 5.4.1.6 The facility must have temperature sensing capabilities. The thermocouple type shall be suitable for the given temperature range (e.g., type K). They shall be mounted to surfaces with pad type sensors and glued/bonded into place to resist dislocation under fire conditions.
- 5.4.1.7 The facility must have voltage and current sensors that are electrically isolated small gauge cables with mechanically secured sensing ends.
- 5.4.1.8 The facility must have an AC impedance meter capable of measuring the DUT at 1 kHz during rest conditions at the specified rate (see Section 6.3.1).
- 5.4.1.9 The facility must have sensors that monitor the applied force and level of displacement during crush testing. A trigger sensor is also required for time synchronization with other recording sources (e.g., video).
- 5.4.1.10 The facility must have a data acquisition system (DAQ) for capturing measured parameters. See Section 6.3.2 for DAQ measurement rates.
- 5.4.1.11 The facility must have standard video recording equipment (at least two cameras for different perspectives).
- 5.4.1.12 The facility must have digital photography equipment.
- 5.4.1.13 The facility must be capable of proper disposal or recycling of damaged/burned DUTs or other byproducts of testing in compliance with environmental regulations.

## 5.5 Test Equipment Calibration

- 5.5.1 A written calibration procedure shall be provided that includes, at a minimum, the following information for all measurement and test equipment:
- Type of equipment, manufacturer, model number, etc.
  - Measurement range
  - Accuracy
  - Calibration interval
  - Type of standard used (calibration traceability of the standard must be evident)

## 6. TEST PROCEDURE

### 6.1 Test Type

- 6.1.1 Crushing is an abusive test that determines a DUT's reaction to mechanical fault conditions.
- 6.1.2 Testing shall be conducted on full-sized RESSs (one RESS per axis). In preparation for full-scale testing, crush testing can also be conducted on single cells, cell strings, and modules to gauge the hazard severity levels with increasing battery size.

### 6.2 Device Under Test

- 6.2.1 The device under test (DUT) shall be a full-sized RESS. The test procedure, however, can also be applied to single cells, cell strings, and modules.
- 6.2.1.1 Single cells may be harvested from a spare RESS unit or may be provided separately by the RESS manufacturer or vehicle OEM.
- 6.2.1.2 Cell strings may be constructed from components harvested from a spare RESS unit, or may be provided separately by the RESS manufacturer or vehicle OEM.
- 6.2.1.3 Modules may be harvested from a RESS unit, or may be provided separately by the RESS manufacturer or vehicle OEM.

### 6.3 Test Guidelines

- 6.3.1 Various sensors shall be installed to collect information regarding the DUT's condition before, during, and after crush testing.
- 6.3.1.1 **Voltage** sensors are used to assess the battery SOC and general DUT condition. The number of voltage sensors depends on the DUT design. At a minimum, the overall DUT voltage shall be monitored. As appropriate, additional voltage sensors can be used to monitor sub-systems (e.g., cells, cell strings, modules, and/or bus bars within the DUT) to access more detailed information on the overall DUT SOC and condition.

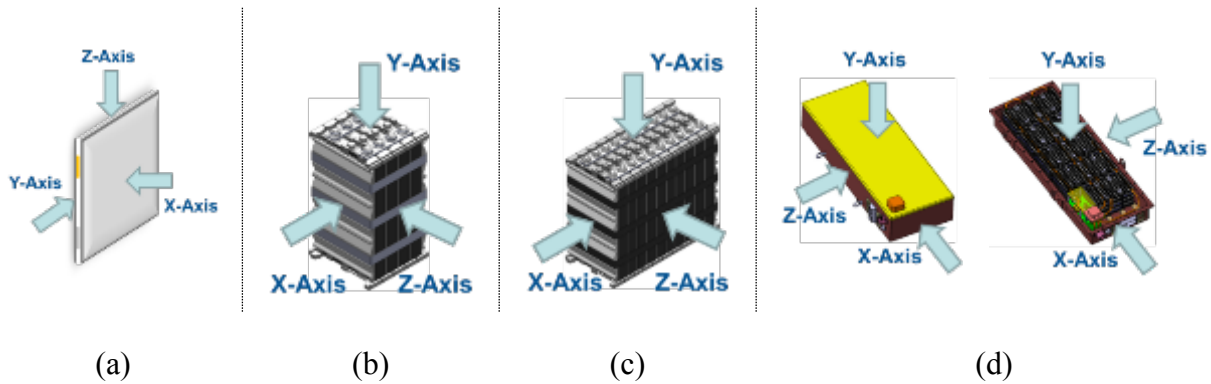


- 6.3.1.2 **Current** sensors are required to monitor the discharge and charge steps during testing as well as the post-test attempted discharge if the crush did not result in a EUCAR hazard severity level of 5 or more. They are also useful for detecting unintended current flows (e.g., a short circuit current due to the crush event). Only one current channel per DUT is required for this test procedure. The current leads must be capable of delivering a 1C rate based on the DUT specifications.
- 6.3.1.3 **Temperature** sensors are used to assess general DUT condition. The number of temperature sensors depends on the DUT design, size, and required level of information (as detailed in a device-specific test plan). At a minimum, temperature sensors should be placed in various locations external and, as appropriate, internal to the DUT.
- 6.3.1.4 **Resistance** is measured using 1 kHz AC impedance during crush testing. Only one current channel per DUT is required for this test procedure. These measurements shall be taken when the DUT is at rest (i.e., not during the discharge/charge portion of the test). The value of this measurement is relative given the large resistances that can be introduced with the required wiring for crush testing.
- 6.3.1.5 **Force** sensors are used to determine the amount of force applied to the DUT during a crush test. Only one channel per DUT is required for this test procedure. It shall be connected to a load cell with a voltage output along with its appropriate scale factor conversion to Newtons.
- 6.3.1.6 **Displacement** sensors are used to determine the position of the platen as a function of the test apparatus and start position. Only one channel per DUT is required for this test procedure. It shall be connected to a linear position sensor with a voltage output along with its appropriate scale factor conversion to millimeters.
- 6.3.1.7 **Trigger** sensors are used to enable time synchronization with other recording sources (e.g., video). Only one channel per DUT is required for this test procedure. It shall be connected to the crush motion signal from the test fixture. Alternatively, a fiducial marker shall be added to the video field of view to enable post-test synchronization.
- 6.3.2 Sensor requirements are summarized in Table 1. The specified data acquisition rates are the minimum requirements during the actual crush steps. The sampling rate may be reduced to 1 Hz during non-crush test steps.

**Table A-1 – Test Channel and Data Acquisition Requirements**

<b>Variable</b>	<b>Units</b>	<b>Minimum Number of Test Channels</b>	<b>Minimum Data Acquisition Rate</b>
Voltage	V	DUT Dependent	10 Hz
Current	A	1	10 Hz
Temperature	°C	DUT Dependent	10 Hz
Resistance	$\Omega \rightarrow$ Relative	1	10 Hz
Force	$V \rightarrow$ N	1	100 Hz
Displacement	$V \rightarrow$ mm	1	100 Hz
Trigger	$V \rightarrow$ Arbitrary	1	10 Hz

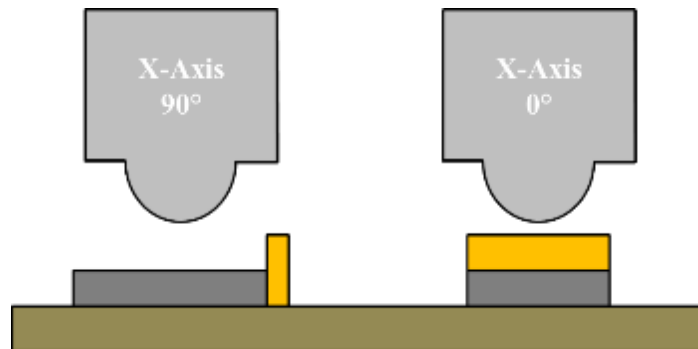
- 6.3.3 For visual correlation of test events and data, two color video recordings with audio should be made. One recording shall be a wide view of the test area (e.g., chamber) and the other shall be a close-up of the test fixture and DUT. The test time shall be synched between video recordings and datalogs. A video file resolution of approximately 1920 x 1080 should be targeted.
- 6.3.4 DUT axes can respond differently to crush testing due to the location of various cell features. Each DUT design and mounting location in an application will be different. Thus, a generic three axis treatment of all directions is defined below and shown in Figure 3.
- 6.3.4.1 **X-axis:** perpendicular to the largest plane of the DUT (i.e., into the broad plane of the electrodes).
- 6.3.4.2 **Y-axis:** perpendicular to the plane containing the DUT's terminals (a constraint fixture parallel to the Y-axis may be needed during crush testing).
- 6.3.4.3 **Z-axis:** the third axes not defined by X or Y. Often known as the thin edge of the cells (a constraint fixture parallel to the Z-axis may be needed during crush testing).



**Figure A-3 – Crush axis definitions for a) cells, b) cell strings, c) modules and d) RESSs.**

### 6.3.5 Platen Rotation:

6.3.5.1 Platen direction is an important consideration for crush testing. Figure 4 shows an example cell (dark grey) and busbar (gold) in an X-axis direction (note that the fixture platen on each side of the cell are not shown). In this example, a cell orientation of  $0^\circ$  results in a crush test that incorporates both the cell and busbar. Rotating the cell orientation  $90^\circ$  results in a crush of just the cell. For this test procedure, the bus bar shall not be crushed to ensure the reaction is only due to the cell mechanical response. Note that for RESS-level testing, it may be easier to rotate the platen instead to ensure the appropriate crush direction.



**Figure A-4 – Platen rotation options; the DUT is shown in dark gray, the bus bar is in gold.**

### 6.3.6 Platen Load:

- 6.3.6.1 The crush fixture should not reach its physical maximum load limit during testing. The minimum load capability should exceed 1,000 times the DUT weight, up to a maximum of 100 kg and 980 kN.
- 6.3.6.2 For DUTs with weights less than 100 kg, a factor of more than 1,000 times the DUT weight should be considered a minimum since the load can be exceeded depending on orientation and case design.
- 6.3.6.3 For DUTs with weights that exceed 100 kg, crush fixtures with load capabilities of 980kN are typically sufficient to avoid hitting a load limit.
- 6.3.6.4 Specific crush fixture requirements should be detailed in a device-specific test plan.

### 6.3.7 Platen Speed:

- 6.3.7.1 The platen speed should be held constant during motion when crush testing (both continuous and start/stop crushing).
- 6.3.7.2 A platen speed of 5 mm/sec shall be used during crush testing. For safety reasons, a platen should be considered in motion with speeds above 1 mm/sec. Oscillating speeds of less than 0.2 mm/sec are associated with instrumentation noise.

### 6.3.8 Platen Travel:

- 6.3.8.1 The platen shall be able to apply crush loads that meet the test requirements (typically 85 percent displacement).
- 6.3.8.2 The platen shall be controllable to enable 5 percent displacement increments during crush testing.

- 6.3.9 Care should be taken to ensure that test leads attached to voltage, current and temperature sensors are isolated from the platen so that connector wires are not damaged or cut during the stroke of the machine.

## 6.4 Test Parameters

- DUT beginning test temperature:  $25\pm 3^{\circ}\text{C}$
- Beginning SOC: 99 percent to 100 percent of the maximum normal operating SOC

## 6.5 DUT Preconditioning

- 6.5.1 Ensure that the DUT is at an ambient temperature of  $25\pm 3^{\circ}\text{C}$ . If not, allow the DUT to thermalize prior to testing.
- 6.5.2 Each DUT shall first be subjected to a controlled discharge/charge pattern. The voltage and current limits vary by DUT and should be provided by the manufacturer or a device-specific test plan.
  - 6.5.2.1 **Discharge** at a 1C rate to the voltage corresponding to 0 percent SOC. Continue to sample appropriate test data (Section 6.3.2).
  - 6.5.2.2 **Charge** at a 1C rate to the voltage corresponding to 100 percent SOC. Continue to sample appropriate test data (Section 6.3.2).
  - 6.5.2.3 **Taper** charge to the voltage corresponding to 100 percent SOC until the current reaches a 0.05C rate. Continue to sample appropriate test data (Section 6.3.2).
- 6.5.3 Crush testing shall begin with the DUT at 100 percent SOC. Voltage and temperature data shall be recorded for a minimum of 2 minutes prior to crush testing (i.e., before initiating any platen motion). The DUT open circuit voltage shall be  $\pm 0.2$  V from the voltage corresponding to 100 percent SOC during the initial 2 minute interval. If it is not, the discharge/charge profile in Section 6.5.2 shall be repeated.
- 6.5.4 During start/stop crush testing (Sections 6.6.3 and 6.6.4), the DUT shall be subjected to a 4-minute discharge/charge pattern as long as the measured voltage signal remains valid.
  - 6.5.4.1 **Discharge** at a 1C rate for 1 minute using the boundary conditions identified in a device-specific test plan. Continue to sample appropriate test data (Section 6.3.2).
  - 6.5.4.2 **Rest** for 1 minute and continue to sample appropriate test data (Section 6.3.2).
  - 6.5.4.3 **Charge** at a 1C rate for 1 minute using the boundary conditions identified in a device-specific test plan. Continue to sample appropriate test data (Section 6.3.2).
  - 6.5.4.4 **Rest** for 1 minute and continue to sample appropriate test data (Section 6.3.2).

## 6.6 Test Methodology

- 6.6.1 Prior to testing, conduct a pre-test inspection on the DUT.
  - 6.6.1.1 Record the DUT open circuit voltage (V).
  - 6.6.1.2 Record the DUT weight (kg).
  - 6.6.1.3 Record the DUT dimensions; height, length, and width (mm).
  - 6.6.1.4 Record the DUT AC impedance at 1 kHz ( $\Omega$ ).

6.6.1.5 Capture a minimum of four digital photos (one from each axis and one isometric).

#### 6.6.2 Continuous Crush Test:

6.6.2.1 Configure the DUT in the X-axis position and secure it in the test fixture.

6.6.2.2 Rest for 2 minutes and observe the open circuit voltage (see Section 6.5.3).

6.6.2.3 Crush the DUT with the platen in one constant motion from 0 percent to 85 percent displacement at a rate of 5 mm/sec.

6.6.2.4 Observe and document the DUT response.

6.6.2.5 End of crush testing is achieved when one of the following conditions are met:

- The target displacement is achieved (i.e., 85% displacement),
- The DUT reaction results in a EUCAR hazard severity level  $\geq 5$  (with no applied spark), or
- The fixture load limit is reached (note that this is an invalid end of test requirement and the crush test should be repeated with a new DUT using a fixture with a higher load capability limit).

6.6.2.6 Repeat Sections 6.6.2.1 through 6.6.2.5 for a new DUT in both the Y- and Z-axis positions.

#### 6.6.3 Start/Stop Crush Test (3 Intervals):

6.6.3.1 Configure the DUT in the X-axis position and secure it in the test fixture.

6.6.3.2 Rest for 2 minutes and observe the open circuit voltage (see Section 6.5.3).

6.6.3.3 Crush the DUT with the platen from 0 percent to 15 percent displacement at a rate of 5 mm/sec and then hold for 30 minutes.

6.6.3.4 If a valid voltage signal is still being measured after 26 minutes into the rest period, attempt to conduct a discharge/charge pattern (see Section 6.5.4) for the remaining 4-minute hold interval. If at any time a voltage signal is lost or the electrical connection proves unresponsive, discontinue the discharge/charge cycle and proceed with the next crush interval (Section 6.6.3.5).

- 6.6.3.5 Crush the DUT with the platen from 15 percent to 50 percent displacement at a rate of 5 mm/sec and then hold for 30 minutes.
- 6.6.3.6 If a valid voltage signal is still being measured after 26 minutes into the rest period, attempt to conduct a discharge/charge pattern (see Section 6.5.4) for the remaining 4-minute hold interval. If at any time a voltage signal is lost or the electrical connection proves unresponsive, discontinue the discharge/charge cycle and proceed with the next crush interval (Section 6.6.3.7).
- 6.6.3.7 Crush the DUT with the platen from 50 percent to 85 percent displacement at a rate of 5 mm/sec and then hold for 30 minutes.
- 6.6.3.8 Observe and document the DUT response.
- 6.6.3.9 End of crush testing is achieved when one of the following conditions are met:
- The target displacement is achieved (i.e., 85% displacement),
  - The DUT reaction results in a EUCAR hazard severity level  $\geq 5$  (with no applied spark), or
  - The fixture load limit is reached (note that this is an invalid end of test requirement and the crush test should be repeated with a new DUT using a fixture with a higher load capability limit).
- 6.6.3.10 Repeat Sections 6.6.3.1 through 6.6.3.9 for a new DUT in both the Y- and Z-axis positions.
- 6.6.4 Start/Stop Crush Test (Multiple Intervals):
- 6.6.4.1 Configure the DUT in the X-axis position and secure it in the test fixture.
- 6.6.4.2 Rest for 2 minutes and observe the open circuit voltage (see Section 6.5.3).
- 6.6.4.3 Crush the DUT with the platen from 0 percent to 5 percent displacement at a rate of 5 mm/sec and then hold for 6 minutes.
- 6.6.4.4 If a valid voltage signal is still being measured after 2 minutes into the rest period, attempt to conduct a discharge/charge pattern (see Section 6.5.4) for the remaining 4-minute hold interval. If at any time a voltage signal is lost or the electrical connection proves unresponsive, discontinue the discharge/charge cycle and proceed with the next crush interval (Section 6.6.4.5).
- 6.6.4.5 Crush the DUT with the platen with an additional displacement of 5 percent at a rate of 5 mm/sec and then hold for 6 minutes.
- 6.6.4.6 If a valid voltage signal is still being measured after 2 minutes into the rest period, attempt to conduct a discharge/charge pattern (see Section 6.5.4) for the remaining 4-minute hold interval. If at any time a voltage signal is lost or the electrical

connection proves unresponsive, discontinue the discharge/charge cycle and proceed with the next crush interval (Section 6.6.4.7).

6.6.4.7 Repeat Sections 6.6.4.5 and 6.6.4.6 until 85 percent displacement is achieved.

6.6.4.8 Observe and document the DUT response.

6.6.4.9 End of crush testing is achieved when one of the following conditions are met:

- The target displacement is achieved (i.e., 85% displacement),
- The DUT reaction results in a EUCAR hazard severity level  $\geq 5$  (with no applied spark), or
- The fixture load limit is reached (note that this is an invalid end of test requirement and the crush test should be repeated with a new DUT using a fixture with a higher load capability limit).

6.6.4.10 Repeat Sections 6.6.4.1 through 6.6.4.9 for a new DUT in both the Y- and Z-axis positions.

6.6.5 Once crush testing is completed, conduct a post-test inspection on the DUT.

6.6.5.1 Record the DUT open circuit voltage (V).

6.6.5.2 Record the DUT weight (kg).

6.6.5.3 Record the DUT dimensions; height, length, and width (mm).

6.6.5.4 Record the DUT AC impedance at 1 kHz ( $\Omega$ ).

6.6.5.5 Capture a minimum of four digital photos (one from each axis and one isometric).

## 6.7 Measured Data

6.7.1 Crush testing on all three axes can yield a significant amount of data. A methodology to analyze the data and produce strategically relevant graphs is recommended for a test report.

6.7.2 DUT crush test reports should include the following information:

- Details on the DUT (size, chemistry, dimensions, etc.).
- Details from the receipt inspection (OCV, weight, AC impedance at 1 kHz, photos).
- Details of the crush test fixture and platen design.
- DUT/platen orientation for crushing on each axis.
- Video of the test from several angles, at least two.
- Details on timing (e.g., test start, time when test steps were initiated, etc.).
- Tabulated/plotted sensor data as determined from Section 6.7.1 (e.g., voltage, temperature, etc.).



- Tabulated/plotted derived parameters as determined from Section 6.7.1 (e.g., SOC, force applied, etc.).
- Details of the DUT response to crush testing (e.g., EUCAR hazard severity level).
- Details from the post-test inspection (OCV, weight, AC impedance at 1 kHz, photos).
- Note any test abnormalities, events, or deviations from the test procedure requirements.

## 6.8 Inspection Method

6.8.1 The post-test monitoring time is dependent on the DUT response to crushing.

6.8.1.1 If the response results in a EUCAR hazard severity level of 2 or less, monitor the DUT for a minimum of 30 minutes.

6.8.1.2 If the response results in a EUCAR hazard severity level of 3 or 4, monitor the DUT for a minimum of 2 hours.

6.8.1.3 If the response results in a EUCAR hazard severity level of 5 or more, monitor the DUT for a minimum of 30 minutes.

6.8.2 After the specified monitoring period is over, determine if the change in temperature over time ( $dT/dt$ ) is  $\leq 0^{\circ}\text{C}/\text{min}$ . If a valid voltage signal is still present after the crush test, also determine if the change in voltage over time ( $dV/dt$ ) is  $\leq 1 \text{ mV}/\text{min}$ . If the DUT does not meet these criteria, repeat the specified monitoring time (see Section 6.8.1) and re-evaluate  $dT/dt$  and  $dV/dt$  again.

6.8.3 Once the  $dT/dt$  and  $dV/dt$  criteria are met, attempt a discharge to 0 percent SOC at a 1C rate. If that fails, apply a fixed load resistor to discharge the DUT. If this also fails, attempt one or more of the following methods (as appropriate) to remove any remaining stranded energy.

- Apply an external heat source to the DUT
- Crush the DUT beyond the test limits
- Immerse the DUT in a salt water bath

6.8.4 During any attempts to discharge the DUT after crushing (if a voltage signal is valid), first attempt a discharge with the compressive load still present. If that fails, remove the load and try again. Record the compressive load value, load duration, and DUT temperature at the time of load removal.

## 6.9 Post-Test Requirements

6.9.1 Care must be taken in handling tested samples because of possible residual charge, chemical or gaseous exposure or physical burns. The samples must be deemed in a safe condition (i.e., remaining energy removed, see Section 6.8.3) and then disposed in accordance with facility standards and governmental regulations for hazardous materials.

## 6.10 Acceptance Criteria

6.10.1 Tests should be monitored and their response categorized according to the EUCAR rating system adopted by in the 2005 FreedomCAR Manual of Test (see Table 2). This rating system appears in various battery test procedure and it is noted that the 2009 revision of SAE J2464 uses a modified rating system that shall not be used.

*Table A-2 – EUCAR Hazard Severity Levels*

Rating	Description	Classification Criteria and Effect
0	No Effect	No Effect. No loss of functionality.
1	Passive protection activated	No defect; no leakage; no venting, fire, or flame; no rupture; no explosion; no exothermic reaction or thermal runaway. Cell reversibly damaged. Repair of protection device needed.
2	Defect / Damage	No leakage; no venting, fire, or flame; no rupture; no explosion; no exothermic reaction or thermal runaway. Cell irreversibly damaged. Repair needed.
3	Leakage $\Delta$ mass < 50%	No venting, fire or flame*; no rupture; no explosion. Weight loss <50% of electrolyte weight (electrolyte = solvent + salt).
4	Venting $\Delta$ mass $\geq$ 50%	No fire or flame*; no rupture; no explosion. Weight loss of $\geq$ 50% of electrolyte weight (electrolyte= solvent + salt).
5	Fire or Flame	No rupture; no explosion (i.e., no flying parts).
6	Rupture	No explosion, but flying parts of the active mass.
7	Explosion	Explosion (i.e., disintegration of the cell).

## **Appendix B: Battery Abuse Overcharge Test Procedure**

## **Battery Abuse Overcharge Test Procedure**

### **1. PURPOSE**

Electric propulsion in a Hybrid Electric Vehicle (HEV), Plug-in Hybrid Electric Vehicle (PHEV) and Electric Vehicle (EV) platform relies on Rechargeable Energy Storage Systems (RESSs), commonly referred to as batteries. However, the automotive application and use of a RESS, such as a lithium-ion (Li-ion) based battery system, poses certain potential risks to vehicle operators and occupants that are different than those associated with an internal combustion engine. The purpose of this test procedure is to assess the reaction of batteries and battery subsystems under electrical overcharge conditions using uniform test methods that are designed to provide consistency in data acquisition and performance between test laboratory sites.

### **2. SCOPE**

This test procedure is designed to collect data from a battery or its subsystems when electrically overcharged beyond the design parameters. Two load patterns are provided for optimized identification of important events and for production of comparative data. As necessary for a specific design, ancillary fixtures may be required to hold the test sample in its proper orientation during the overcharge. Although the intent of this procedure is to evaluate the RESS response to an overcharge condition, it can also be applied to cells, cell strings, and modules, to more thoroughly identify failure mechanisms and propagation effects.

### **3. REFERENCES**

#### **3.1 Applicable Publications**

N/A

#### **3.2 Related Publications**

The following publications are provided for information purposes only and are not a required part of this document.

##### **3.2.1 Sandia National Laboratories Publications**

Available from Sandia National Laboratories, [www.sandia.gov](http://www.sandia.gov).

- SAND2005-3123 FreedomCAR Electrical Energy Storage System Abuse Test Manual for Electric and Hybrid Electric Vehicle Applications

### 3.2.2 SAE Publications

Available from the SAE International, [www.sae.org](http://www.sae.org)

- SAE J1715 Hybrid Electric Vehicle (HEV) and Electric Vehicle (EV) Terminology
- SAE J2464 Electric and Hybrid Electric Vehicle Rechargeable Energy Storage System (RESS) Safety and Abuse Testing
- SAE J2929 Electric and Hybrid Vehicle Propulsion System Safety Standard – Lithium-Based Rechargeable Cells

### 3.2.3 ISO Publications

Available from International Standards Organization (ISO), [www.iso.org](http://www.iso.org)

- ISO 12405-4 Electrically propelled road vehicles – Test specification for lithium-ion traction battery packs and systems – Part 4: Performance testing
- ISO 12405-3 Electrically propelled road vehicles – Test specification for lithium-ion traction battery packs and systems – Part 3: Safety performance requirements

### 3.2.4 United Nations Publications

Available from United Nations Economic Commission for Europe, [www.unece.org](http://www.unece.org)

- Recommendations on the Transport of Dangerous Goods, Manual of Tests and Criteria, 5th Revised Edition, 2011, Section 38.3, “Lithium metal and lithium ion batteries”
- Regulation No. 100 – Rev.2, Addenda to the 1958 Agreement ECE R100, 2013, “Uniform provisions concerning the approval of vehicles with regard to specific requirements for the electric power train”

## 4. DEFINITIONS

Except as noted below, all definitions are in accordance with SAE J1715.

### Battery

A device comprising one or more individual electrochemical cells connected in series and/or in parallel or modules packaged together with associated protection electronics and mechanical enclosure.

### Battery Cell (Cell)

The basic electrochemical unit of a battery, containing an anode and cathode, electrolyte, and typically separator. A cell is a self-contained energy storage and conversion device whose function is to deliver electrical energy to an external circuit. Energy is stored within the cell as chemical energy.

### Battery Cell String (String)

A group of interconnected cells into a common mechanical and electrical unit (i.e., a series and/or parallel configuration). Although similar, a string is smaller than a battery module.

### Battery Module

A group of interconnected cells in a single mechanical and electrical unit that is a subassembly of a full battery.

### Device Under Test (DUT)

A device that is subjected to the performance testing requirements defined herein. For the overcharge test procedure, the DUT can consist of cells, cell strings, modules, or RESSs.

### Emergency Response Guide (ERG)

A document describing the hazards that may be encountered during an emergency response operation involving an “article.” The Occupational Safety and Health Administration (OSHA) has defined “article” as a manufactured item other than a fluid or particle; (i) which is formed to a specific shape or design during manufacture; (ii) which has end use functions dependent in whole or in part on its shape or design during end use; and (iii) which under normal conditions of use does not release more than very small quantities (e.g., minute or trace amounts) of a hazardous chemical, and does not pose a physical hazard or health risk to employees.

### EV: Electric Vehicle

An automobile type vehicle, powered by an electric motor that draws energy solely from a rechargeable energy storage device.

### Fixture

A mechanical assembly surrounding the DUT that is designed to keep the DUT engaged during an overcharge event. The fixture may or may not be necessary depending on the mechanical stability of the DUT.

### Hazard Severity level (HSL)

A rating system that categorizes the severity level of a RESS reaction to abuse conditions. This procedure uses the European Council for Automotive Research and Development (EUCAR) rating system.

### HEV: Hybrid Electric Vehicle

An automobile type vehicle, powered by an internal combustion engine and an electric motor that draws stored energy from a rechargeable energy storage device for power assist.

### Lithium-Ion (Li-ion)

The term lithium-ion or Li-ion refers to an entire family of battery chemistries where the negative electrode (anode) and positive electrode (cathode) materials serve as a host for the lithium ion ( $\text{Li}^+$ ). Lithium ions move from the anode to the cathode during discharge and are intercalated into (i.e., inserted into voids in the crystallographic structure of) or otherwise react with the cathode. The ions reverse direction during charging and are intercalated into the anode material.

### Material Safety Data Sheet (MSDS)

A document that contains information on the potential hazards (health, fire, reactivity and environmental) of a chemical product.

### Personal Protective Equipment (PPE)

Clothing, helmets, goggles, or other garments or equipment designed to protect the wearer's body from injury.

### PHEV: Plug-in Hybrid Electric Vehicle

A hybrid vehicle with the ability to store and use off-board electrical energy in a rechargeable energy storage device. A range extended EV is a type of PHEV.

### Rechargeable Energy Storage System (RESS)

The RESS is a completely functional energy storage system consisting of a battery packs, necessary ancillary subsystems for physical support and enclosure, thermal management and control, and electronic systems control.

### State-of-Charge

The discharge capacity in ampere-hours of a battery, expressed as a percentage of the battery ampere-hour capacity.

### Thermal Runaway

Thermal runaway refers to rapid self-heating of a battery cell derived from the exothermic chemical reaction of the highly oxidizing positive electrode and the highly reducing negative electrode. It can occur with batteries of almost any chemistry. In a thermal runaway reaction, a cell rapidly releases its stored energy. At the end of a thermal runaway reaction, no electrical energy will be stored within the cell. Note that a measurement of 0 V at cell terminals alone is

not evidence of thermal runaway. The cell may also have vented electrolyte, undergone a variety of irreversible chemical reactions, or have melted or burned components or activated internal protection mechanisms.

### Venting

The release of excessive internal pressure from a RESS cell, module, or battery pack in a manner intended by design to preclude rupture or explosion.

## **5. GENERAL TEST REQUIREMENTS**

### **5.1 General Precautions**

- 5.1.1 Conducting overcharge testing on any cell chemistry is potentially hazardous. A battery of any size (cell, cell string, module, and RESS) can emit flammable or toxic vapors, become very hot, ignite, eject corrosive or toxic liquids, or undergo an energetic disassembly.
  - 5.1.1.1 Prior to conducting overcharge testing, the individuals conducting testing should become familiar with the contents of a battery or cell and the related potential hazards; appropriate personal protective equipment (PPE) should also be assembled. A Material Safety Data Sheet (MSDS) or Emergency Response Guide (ERG) may provide relevant information.
  - 5.1.1.2 Testing should be conducted in a well-ventilated environment with provisions to mitigate smoke, flammable vapors, or toxic vapors. Should an air scrubbing system be used, the system filters should be selected as appropriate for the specific cell chemistry. System filters should be protected from ignition if emitted gas could be heated, is flammable, or a spark emission is expected. If testing will be conducted in open air, the testing agency should secure necessary burn permits.
  - 5.1.1.3 If emission of flammable gases is possible, the testing facility should be prepared to mitigate the hazards of an unintentional ignition. Potential methods of mitigation include flammable gas monitoring, capability to remotely activate appropriate fire suppression systems, and high-volume vapor dilution systems.
  - 5.1.1.4 Personnel conducting testing should be equipped with appropriate PPE such as a respirator with appropriate cartridges or Self-Contained Breathing Apparatus (SCBA), eye protection (safety glasses, goggles, or face shield), chemical resistant gloves, high voltage resistant gloves, high temperature resistant gloves, and flame or chemical resistant clothing (e.g., Nomex coveralls, turn-out gear, etc.). The testing agency should determine appropriate PPE prior to beginning of testing.



- 5.1.1.5 Personnel conducting testing should be separated from contact with ejected liquids or debris. This may include use of testing chamber, a testing enclosure, or designation of a minimum safe distance to the test article.
- 5.1.1.6 Personnel should be aware that test components can achieve high temperatures and can pose a burn hazard.
- 5.1.2 Batteries damaged by overcharge testing may present a potential high voltage electrical shock hazard. Test personnel should have appropriate PPE when approaching damaged batteries.
- 5.1.3 Test personnel shall use nonconductive or insulated tooling when working with the DUT.
- 5.1.4 Battery systems and test fixtures can be heavy and may require lifting. Removal after testing may pose additional difficulties (see Section 5.1.6).
- 5.1.5 Battery terminals should remain isolated until testing is ready to begin to avoid inadvertent shorting.
- 5.1.6 After testing has concluded, test articles may be damaged and pose a hazard during test cleanup. Stranded energy should be considered during post-test conditions and before battery disposal. Post-test isolation may also be compromised. Prior to handling conductive surfaces, the system shall be checked for isolation faults. Appropriate PPE might include Tyvek and respirators for post-test cleanup, depending on the facility requirements and battery chemistry. Post-test damaged terminals may not reliably indicate the total energy left in a battery. The testing agency should develop a plan for handling and disposing of damaged test articles.

## **5.2 Test Specific Precautions**

- 5.2.1 Overcharge testing may cause energetic reactions including toxic gas discharge, particulate generation, smoke and fire. Laboratories must be prepared to accommodate deleterious events associated with these procedures.
- 5.2.2 Testing equipment should be located in an area with isolating walls that can contain any flying debris and vents any gaseous discharge away from test personnel.
- 5.2.3 Criteria for the safe approach of a battery after overcharge testing should be considered before re-entry into the test area (e.g., allowing sufficient time for ventilation and temperature cooling).
- 5.2.4 Cleanup and disposal should follow industrial hygiene guidelines including proper PPE to be worn during this process.
- 5.2.5 A sparker shall not be used unless required by the specific test facility and/or a significant DUT vent occurs.

### 5.3 Safety Requirements

- 5.3.1 The testing agency must develop a specific safety plan for each overcharge test, including a list of required PPE. This safety plan should be based on information provided by the manufacturer regarding DUT chemistry and system architecture as well as precautions typically associated with high voltage systems. See discussion in Sections 5.1 and 5.2.

### 5.4 Test Facility/ Equipment Requirements

- 5.4.1 Facility and equipment requirements for overcharge testing:

- 5.4.1.1 The facility must have appropriate PPE such as respirators, safety glasses, and high voltage gloves. See discussion in Sections 5.1 and 5.2.
- 5.4.1.2 The facility must have a thermal chamber or temperature-controlled area for thermally soaking the DUT to a temperature of  $25\pm 3^{\circ}\text{C}$  (see Section 6.4).
- 5.4.1.3 The facility must have a battery tester that can supply the required constant current while also ensuring that the voltage compliance and power delivery limits are never reached during the test. Tester requirements are DUT dependent and should be included in a device-specific test plan.

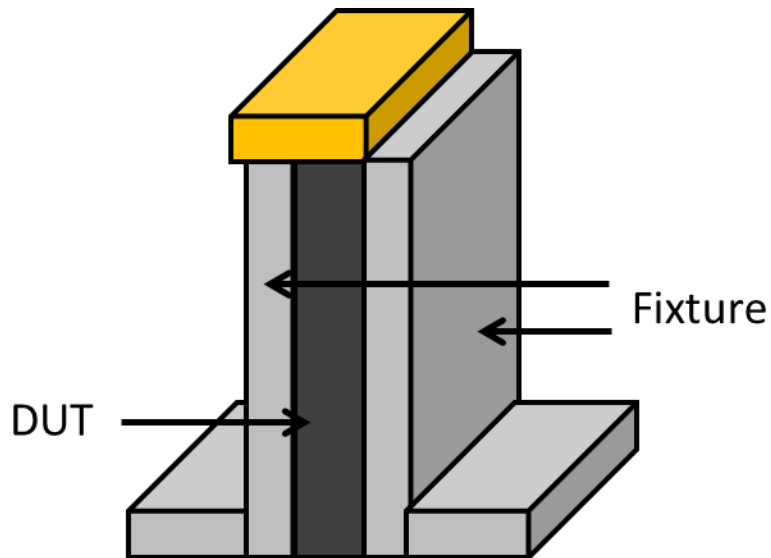
Testing currents should range from the maximum values found in AC Level 2 circuits (32 A) to the highest level of charging the battery is likely to experience. A representative upper bound could be 200 A, as found in proposed DC Level 2 circuits. The actual current requirements are DUT dependent and should be included in a device-specific test plan.

- 5.4.1.4 If necessary, the facility must be equipped with an appropriate fixture for holding test samples when conducting overcharge tests. A fixture design example is shown in Figure 1, where the DUT is a single cell. The fixture consists of two plates that are secured in the appropriate orientation to hold the DUT during the overcharge test.

During an overcharge test, it is possible for a battery to generate significant internal gassing as a byproduct. This gassing will exert a pressure on the DUT casing and may also result in significant swelling. Thus, the addition of mechanical fixtures may also be necessary to prevent DUT swelling from interfering with the test.

- 5.4.1.5 The facility must have temperature sensing capabilities. The thermocouple type shall be suitable for the given temperature range (e.g., type K). They shall be mounted to surfaces with pad type sensors and glued/bonded into place to resist dislocation under fire conditions.

- 5.4.1.6 The facility must have voltage and current sensors that are electrically isolated small gauge cables with mechanically secured sensing ends.
- 5.4.1.7 The facility must have an AC impedance meter capable of measuring the DUT at 1 kHz during rest conditions as specified.



*Figure B-1 – Overcharge fixture example; the fixture plates and platen are shown in gray and the DUT is shown in dark gray with a gold bus bar.*

- 5.4.1.8 The facility must have a data acquisition system (DAQ) for capturing measured parameters. See Section 6.3.2 for DAQ measurement rates.
- 5.4.1.9 The facility must have standard video recording equipment (at least two cameras for different perspectives).
- 5.4.1.10 The facility must have digital photography equipment.
- 5.4.1.11 The facility must be capable of proper disposal or recycling of damaged/burned DUTs or other byproducts of testing in compliance with environmental regulations.

## 5.5 Test Equipment Calibration

- 5.5.1 A written calibration procedure shall be provided that includes, at a minimum, the following information for all measurement and test equipment.
- Type of equipment, manufacturer, model number, etc.
  - Measurement range
  - Accuracy
  - Calibration interval
  - Type of standard used (calibration traceability of the standard must be evident)

## 6. TEST PROCEDURE

### 6.1 Test Type

- 6.1.1 Overcharging is an abusive test that determines a DUT's reaction to electrical fault conditions.
- 6.1.2 Testing shall be conducted on full-sized RESSs. In preparation for full-scale testing, overcharge testing can also be conducted on single cells, cell strings, and modules to gauge the hazard severity levels with increasing battery size.

### 6.2 Device Under Test

- 6.2.1 The device under test (DUT) shall be a full-sized RESS. The test procedure, however, can also be applied to single cells, cell strings, and modules.
  - 6.2.1.1 Single cells may be harvested from a spare RESS unit or may be provided separately by the RESS manufacturer or vehicle OEM.
  - 6.2.1.2 Cell strings may be constructed from components harvested from a spare RESS unit, or may be provided separately by the RESS manufacturer or vehicle OEM.
  - 6.2.1.3 Modules may be harvested from a RESS unit, or may be provided separately by the RESS manufacturer or vehicle OEM.

### 6.3 Test Guidelines

- 6.3.1 Various sensors shall be installed to collect information regarding the DUT's condition before, during, and after overcharge testing.
  - 6.3.1.1 **Voltage** sensors are used to assess the battery SOC and general DUT condition. The number of voltage sensors depends on the DUT design. At a minimum, the overall DUT voltage shall be monitored. As appropriate, additional voltage sensors can be used to monitor sub-systems (e.g., cells, cell strings, modules, and/or bus bars within the DUT) to access more detailed information on the overall DUT SOC and condition.

- 6.3.1.2 **Current** sensors are required to monitor the charge during testing as well as the post-test attempted discharge if the overcharge did not result in a EUCAR hazard severity level of 5 or more. Only one current channel per DUT is required for this test procedure. The test leads must be capable of delivering the targeted current based on the DUT specifications (a minimum of a 1C rate).
- 6.3.1.3 **Temperature** sensors are used to assess general DUT condition. The number of temperature sensors depends on the DUT design, size, and required level of information (as detailed in a device-specific test plan). At a minimum, temperature sensors should be placed in various locations external and, as appropriate, internal to the DUT.
- 6.3.2 Sensor requirements are summarized in Table 1. The specified data acquisition rates are the minimum requirements during the actual overcharge steps. The sampling rate may be reduced to 1 Hz during non-overcharge test steps.

*Table B-1 – Test Channel and Data Acquisition Requirements*

<b>Variable</b>	<b>Units</b>	<b>Minimum Number of Test Channels</b>	<b>Minimum Data Acquisition Rate</b>
Voltage	V	DUT Dependent	10 Hz
Current	A	1	10 Hz
Temperature	°C	DUT Dependent	10 Hz

- 6.3.3 For visual correlation of test events and data, two color video recordings with audio should be made. One recording shall be a wide view of the test area (e.g., chamber) and the other shall be a close-up of the test fixture and DUT. The test time shall be synched between video recordings and datalogs. A video file resolution of approximately 1920 x 1080 should be targeted.
- 6.3.4 Care should be taken to ensure that test leads attached to voltage, current and temperature sensors are isolated from each other such that they do not cause interference.

#### **6.4 Test Parameters**

- DUT beginning test temperature: 25±3°C
- Beginning SOC: 99 percent to 100 percent of the maximum normal operating SOC

## 6.5 DUT Preconditioning

- 6.5.1 Ensure that the DUT is at an ambient temperature of  $25\pm 3^{\circ}\text{C}$ . If not, allow the DUT to thermalize prior to testing.
- 6.5.2 Each DUT shall first be subjected to a controlled discharge/charge pattern. The voltage and current limits vary by DUT and should be provided by the manufacturer or a device-specific test plan.
  - 6.5.2.1 **Discharge** at a 1C rate to the voltage corresponding to 0 percent SOC. Continue to sample appropriate test data (Section 6.3.2).
  - 6.5.2.2 **Charge** at a 1C rate to the voltage corresponding to 100 percent SOC. Continue to sample appropriate test data (Section 6.3.2).
  - 6.5.2.3 **Taper** charge to the voltage corresponding to 100 percent SOC until the current reaches a 0.05C rate. Continue to sample appropriate test data (Section 6.3.2).
- 6.5.3 Prior to overcharge testing, at least one full discharge from 100 percent SOC shall be conducted on the DUT using the procedure defined in Section 6.5.2.1 to determine its specific capacity capability. This is followed by a full charge to 100 percent SOC using the procedure defined in Sections 6.5.2.2 and 6.5.2.3. The experimentally determined capacity shall be used to determine SOC during overcharge testing.
- 6.5.4 Overcharge testing shall begin with the DUT at 100 percent SOC. Voltage and temperature data shall be recorded for a minimum of 2 minutes prior to overcharge testing. The DUT open circuit voltage shall be  $\pm 0.2\text{ V}$  from the voltage corresponding to 100 percent SOC during the initial 2 minute interval. If it is not, the discharge/charge profile in Section 6.5.2 shall be repeated.

## 6.6 Test Methodology

- 6.6.1 Prior to testing, conduct a pre-test inspection on the DUT.
  - 6.6.1.1 Record the DUT open circuit voltage (V).
  - 6.6.1.2 Record the DUT weight (kg).
  - 6.6.1.3 Record the DUT dimensions; height, length, and width (mm).
  - 6.6.1.4 Record the DUT AC impedance at 1 kHz ( $\Omega$ ).
  - 6.6.1.5 Capture a minimum of four digital photos (one from each axis and one isometric).

## 6.6.2 Continuous Overcharge Test:

- 6.6.2.1 Secure the DUT in the test fixture.
- 6.6.2.2 Rest for 2 minutes and observe the open circuit voltage (see Section 6.5.4).
- 6.6.2.3 Overcharge the DUT from 100 percent SOC to 200 percent SOC using constant current (the current level should be provided in a device-specific test plan).
- 6.6.2.4 Observe and document the DUT response.
- 6.6.2.5 End of overcharge testing is achieved when one of the following conditions are met:
  - The target SOC is achieved (i.e., 200% SOC),
  - The DUT reaction results in a EUCAR hazard severity level  $\geq 5$  (with no applied spark), or
  - The tester voltage compliance level is reached (note that this is an invalid end of test requirement and the overcharge test should be repeated with a new DUT using a tester with a higher voltage compliance level).

## 6.6.3 Start/Stop Overcharge Test (Multiple Intervals):

- 6.6.3.1 Secure the DUT in the test fixture.
- 6.6.3.2 Rest for 2 minutes and observe the open circuit voltage (see Section 6.5.4).
- 6.6.3.3 Overcharge the DUT from 100 percent SOC to 105 percent SOC using constant current (the current level should be provided in a device-specific test plan), followed by a rest step. The total charge/rest interval shall be 6 minutes. The constant current charge step shall be maximum of 3 minutes (i.e., a 1C rate at a minimum) and the rest period shall be a minimum of 3 minutes.
- 6.6.3.4 Overcharge the DUT with an additional 5 percent SOC using constant current (the current level should be provided in a device-specific test plan), followed by a rest step. The total charge/rest interval shall be 6 minutes. The constant current charge step shall be maximum of 3 minutes (i.e., a 1C rate at a minimum) and the rest period shall be a minimum of 3 minutes.
- 6.6.3.5 Repeat Section 6.6.3.4 until 200 percent SOC is achieved.
- 6.6.3.6 Observe and document the DUT response.
- 6.6.3.7 End of overcharge testing is achieved when one of the following conditions are met:

- The target SOC is achieved (i.e., 200% SOC),
- The DUT reaction results in a EUCAR hazard severity level  $\geq 5$  (with no applied spark), or
- The tester voltage compliance level is reached (note that this is an invalid end of test requirement and the overcharge test should be repeated with a new DUT using a tester with a higher voltage compliance level).

6.6.4 Once overcharge testing is completed, conduct a post-test inspection on the DUT.

6.6.4.1 Record the DUT open circuit voltage (V).

6.6.4.2 Record the DUT weight (kg).

6.6.4.3 Record the DUT dimensions; height, length, and width (mm).

6.6.4.4 Record the DUT AC impedance at 1 kHz ( $\Omega$ ).

6.6.4.5 Capture a minimum of four digital photos (one from each axis and one isometric).

## 6.7 Measured Data

6.7.1 Overcharge testing can yield a significant amount of data. A methodology to analyze the data and produce strategically relevant graphs is recommended for a test report.

6.7.2 DUT overcharge test reports should include the following information:

- Details on the DUT (size, chemistry, dimensions, etc.).
- Details from the receipt inspection (OCV, weight, AC impedance at 1 kHz, photos).
- Details of the overcharge test fixture.
- Video of the test from several angles, at least two.
- Details on timing (e.g., test start, time when test steps were initiated, etc.).
- Tabulated/plotted sensor data as determined from Section 6.7.1 (e.g., voltage, temperature, etc.).
- Tabulated/plotted derived parameters as determined from Section 6.7.1 (e.g., SOC, etc.).
- Details of the DUT response to overcharge testing (e.g., EUCAR hazard severity level).
- Details from the post-test inspection (OCV, weight, AC impedance at 1 kHz, photos).
- Note any test abnormalities, events, or deviations from the test procedure requirements.



## 6.8 Inspection Method

- 6.8.1 The post-test monitoring time is dependent on the DUT response to overcharge.
- 6.8.1.1 If the response results in a EUCAR hazard severity level of 2 or less, monitor the DUT for a minimum of 30 minutes.
  - 6.8.1.2 If the response results in a EUCAR hazard severity level of 3 or 4, monitor the DUT for a minimum of 2 hours.
  - 6.8.1.3 If the response results in a EUCAR hazard severity level of 5 or more, monitor the DUT for a minimum of 30 minutes.
- 6.8.2 After the specified monitoring period is over, determine if the change in temperature over time ( $dT/dt$ ) is  $\leq 0^{\circ}\text{C}/\text{min}$ . If a valid voltage signal is still present after the overcharge test, also determine if the change in voltage over time ( $dV/dt$ ) is  $\leq 1 \text{ mV}/\text{min}$ . If the DUT does not meet these criteria, repeat the specified monitoring time (see Section 6.8.1) and re-evaluate  $dT/dt$  and  $dV/dt$  again.
- 6.8.3 Once the  $dT/dt$  and  $dV/dt$  criteria are met, attempt a discharge to 0 percent SOC at a 1C rate. If that fails, apply a fixed load resistor to discharge the DUT. If this also fails, attempt one or more of the following methods (as appropriate) to remove any remaining stranded energy:
- Apply an external heat source to the DUT
  - Mechanically crush of the DUT
  - Immerse the DUT in a salt water bath

## 6.9 Post-Test Requirements

- 6.9.1 Care must be taken in handling tested samples because of possible residual charge, chemical or gaseous exposure or physical burns. The samples must be deemed in a safe condition (i.e., remaining energy removed, see Section 6.8.3) and then disposed in accordance with facility standards and governmental regulations for hazardous materials.

## 6.10 Acceptance Criteria

- 6.10.1 Tests should be monitored and their response categorized according to the EUCAR rating system adopted by in the 2005 FreedomCAR Manual of Test (see Table 2). This rating system appears in various battery test procedure and it is noted that the 2009 revision of SAE J2464 uses a modified rating system that shall not be used.

**Table B-2 – EUCAR Hazard Severity Levels**

<b>Rating</b>	<b>Description</b>	<b>Classification Criteria and Effect</b>
0	No Effect	No Effect. No loss of functionality.
1	Passive protection activated	No defect; no leakage; no venting, fire, or flame; no rupture; no explosion; no exothermic reaction or thermal runaway. Cell reversibly damaged. Repair of protection device needed.
2	Defect / Damage	No leakage; no venting, fire, or flame; no rupture; no explosion; no exothermic reaction or thermal runaway. Cell irreversibly damaged. Repair needed.
3	Leakage $\Delta$ mass < 50%	No venting, fire or flame*; no rupture; no explosion. Weight loss <50% of electrolyte weight (electrolyte = solvent + salt).
4	Venting $\Delta$ mass $\geq$ 50%	No fire or flame*; no rupture; no explosion. Weight loss of $\geq$ 50% of electrolyte weight (electrolyte= solvent + salt).
5	Fire or Flame	No rupture; no explosion (i.e., no flying parts).
6	Rupture	No explosion, but flying parts of the active mass.
7	Explosion	Explosion (i.e., disintegration of the cell).

## **Appendix C: Battery Abuse Short Circuit Test Procedure**

## **Battery Abuse Short Circuit Test Procedure**

### **1. PURPOSE**

Electric propulsion in a hybrid electric vehicle (HEV), plug-in hybrid electric vehicle (PHEV), and electric vehicle (EV) platform relies on rechargeable energy storage systems, commonly referred to as batteries. However, the automotive application and use of a RESS, such as a lithium-ion (Li-ion) based battery system, poses certain potential risks to vehicle operators and occupants that are different than those associated with an internal combustion engine. The purpose of this test procedure is to assess the reaction of batteries and battery subsystems under electrical short circuit conditions using uniform test methods that are designed to provide consistency in data acquisition and performance between test laboratory sites.

### **2. SCOPE**

This test procedure is designed to collect data from a battery or its subsystems when electrically short circuited. Three resistance ranges are provided for optimized identification of important events and for production of comparative data. As necessary for a specific design, ancillary fixtures may be required to hold the test sample in its proper orientation during the short circuit. Although the intent of this procedure is to evaluate the RESS response to a short circuit condition, it can also be applied to cells, cell strings, and modules, to more thoroughly identify failure mechanisms and propagation effects.

### **3. REFERENCES**

#### **3.1 Applicable Publications**

N/A

#### **3.2 Related Publications**

The following publications are provided for information purposes only and are not a required part of this document.

##### **3.2.1 Sandia National Laboratories Publications**

Available from Sandia National Laboratories, [www.sandia.gov](http://www.sandia.gov)

- SAND2005-3123 FreedomCAR Electrical Energy Storage System Abuse Test Manual for Electric and Hybrid Electric Vehicle Applications

### 3.2.2 SAE Publications

Available from the SAE International, [www.sae.org](http://www.sae.org)

- SAE J1715 Hybrid Electric Vehicle (HEV) and Electric Vehicle (EV) Terminology
- SAE J2464 Electric and Hybrid Electric Vehicle Rechargeable Energy Storage System (RESS) Safety and Abuse Testing
- SAE J2929 Electric and Hybrid Vehicle Propulsion System Safety Standard – Lithium-Based Rechargeable Cells

### 3.2.3 ISO Publications

Available from International Standards Organization, [www.iso.org](http://www.iso.org)

- ISO 12405-4 Electrically propelled road vehicles – Test specification for lithium-ion traction battery packs and systems – Part 4: Performance testing
- ISO 12405-3 Electrically propelled road vehicles – Test specification for lithium-ion traction battery packs and systems – Part 3: Safety performance requirements

### 3.2.4 United Nations Publications

Available from United Nations Economic Commission for Europe, [www.unece.org](http://www.unece.org)

- Recommendations on the Transport of Dangerous Goods, Manual of Tests and Criteria, 5th Revised Edition, 2011, Section 38.3, “Lithium metal and lithium ion batteries”
- Regulation No. 100 – Rev.2, Addenda to the 1958 Agreement ECE R100, 2013, “Uniform provisions concerning the approval of vehicles with regard to specific requirements for the electric power train”

## 4. DEFINITIONS

Except as noted below, all definitions are in accordance with SAE J1715.

### Battery

A device comprising one or more individual electrochemical cells connected in series and/or in parallel or modules packaged together with associated protection electronics and mechanical enclosure.

### Battery Cell (Cell)

The basic electrochemical unit of a battery, containing an anode and cathode, electrolyte, and typically separator. A cell is a self-contained energy storage and conversion device whose function is to deliver electrical energy to an external circuit. Energy is stored within the cell as chemical energy.

### Battery Cell String (String)

A group of interconnected cells into a common mechanical and electrical unit (i.e., a series and/or parallel configuration). Although similar, a string is smaller than a battery module.

### Battery Module

A group of interconnected cells in a single mechanical and electrical unit that is a subassembly of a full battery.

### Device Under Test (DUT)

A device that is subjected to the performance testing requirements defined herein. For the short circuit test procedure, the DUT can consist of cells, cell strings, modules, or RESSs.

### Emergency Response Guide (ERG)

A document describing the hazards that may be encountered during an emergency response operation involving an “article”. The Occupational Safety and Health Administration (OSHA) has defined “article” as a manufactured item other than a fluid or particle; (i) which is formed to a specific shape or design during manufacture; (ii) which has end use functions dependent in whole or in part on its shape or design during end use; and (iii) which under normal conditions of use does not release more than very small quantities (e.g., minute or trace amounts) of a hazardous chemical, and does not pose a physical hazard or health risk to employees.

### EV: Electric Vehicle

An automobile type vehicle, powered by an electric motor that draws energy solely from a rechargeable energy storage device.

### Fixture

A mechanical assembly surrounding the DUT that is designed to keep the DUT engaged during a short circuit event. The fixture may or may not be necessary depending on the mechanical stability of the DUT.

### Hazard Severity level (HSL)

A rating system that categorizes the severity level of a RESS reaction to abuse conditions. This procedure uses the European Council for Automotive Research and Development (EUCAR) rating system.

### HEV: Hybrid Electric Vehicle (HEV)

An automobile type vehicle, powered by an internal combustion engine and an electric motor that draws stored energy from a rechargeable energy storage device for power assist.

### Lithium-Ion (Li-ion)

The term lithium-ion or Li-ion refers to an entire family of battery chemistries where the negative electrode (anode) and positive electrode (cathode) materials serve as a host for the lithium ion ( $\text{Li}^+$ ). Lithium ions move from the anode to the cathode during discharge and are intercalated into (i.e., inserted into voids in the crystallographic structure of) or otherwise react with the cathode. The ions reverse direction during charging and are intercalated into the anode material.

### Material Safety Data Sheet (MSDS)

A document that contains information on the potential hazards (health, fire, reactivity and environmental) of a chemical product.

### Personal Protective Equipment (PPE)

Clothing, helmets, goggles, or other garments or equipment designed to protect the wearer's body from injury.

### PHEV: Plug-in Hybrid Electric Vehicle

A hybrid vehicle with the ability to store and use off-board electrical energy in a rechargeable energy storage device. A range extended EV is a type of PHEV.

### Rechargeable Energy Storage System (RESS)

The RESS is a completely functional energy storage system consisting of a battery packs, necessary ancillary subsystems for physical support and enclosure, thermal management and control, and electronic systems control.

### Resistance Ratio

A ratio that is determined from dividing the applied external short circuit resistance by the DUT resistance. This procedure defines the ratio of the resistances to be applied in a short circuit test rather than an absolute value.

### State-of-Charge

The discharge capacity in ampere-hours of a battery, expressed as a percentage of the battery ampere-hour capacity.

### Thermal Runaway

Thermal runaway refers to rapid self-heating of a battery cell derived from the exothermic chemical reaction of the highly oxidizing positive electrode and the highly reducing negative electrode. It can occur with batteries of almost any chemistry. In a thermal runaway reaction, a cell rapidly releases its stored energy. At the end of a thermal runaway reaction, no electrical

energy will be stored within the cell. Note that a measurement of 0 V at cell terminals alone is not evidence of thermal runaway. The cell may also have vented electrolyte, undergone a variety of irreversible chemical reactions, or have melted or burned components or activated internal protection mechanisms.

### Venting

The release of excessive internal pressure from a RESS cell, module, or battery pack in a manner intended by design to preclude rupture or explosion.

## **5. GENERAL TEST REQUIREMENTS**

### **5.1 General Precautions**

- 5.1.1 Conducting short circuit testing on any cell chemistry is potentially hazardous. A battery of any size (cell, cell string, module, and RESS) can emit flammable or toxic vapors, become very hot, ignite, eject corrosive or toxic liquids, or undergo an energetic disassembly.
  - 5.1.1.1 Prior to conducting short circuit testing, the individuals conducting testing should become familiar with the contents of a battery or cell and the related potential hazards; appropriate personal protective equipment (PPE) should also be assembled. A Material Safety Data Sheet (MSDS) or Emergency Response Guide (ERG) may provide relevant information.
  - 5.1.1.2 Testing should be conducted in a well-ventilated environment with provisions to mitigate smoke, flammable vapors, or toxic vapors. Should an air scrubbing system be used, the system filters should be selected as appropriate for the specific cell chemistry. System filters should be protected from ignition if emitted gas could be heated, is flammable, or a spark emission is expected. If testing will be conducted in open air, the testing agency should secure necessary burn permits.
  - 5.1.1.3 If emission of flammable gases is possible, the testing facility should be prepared to mitigate the hazards of an unintentional ignition. Potential methods of mitigation include flammable gas monitoring, capability to remotely activate appropriate fire suppression systems, and high-volume vapor dilution systems.
  - 5.1.1.4 Personnel conducting testing should be equipped with appropriate PPE such as a respirator with appropriate cartridges or Self-Contained Breathing Apparatus (SCBA), eye protection (safety glasses, goggles, or face shield), chemical resistant gloves, high voltage resistant gloves, high temperature resistant gloves, and flame or chemical resistant clothing (e.g., Nomex coveralls, turn-out gear, etc.). The testing agency should determine appropriate PPE prior to beginning of testing.



- 5.1.1.5 Personnel conducting testing should be separated from contact with ejected liquids or debris. This may include use of testing chamber, a testing enclosure, or designation of a minimum safe distance to the test article.
- 5.1.1.6 Personnel should be aware that test components can achieve high temperatures and can pose a burn hazard.
- 5.1.2 Batteries damaged by short circuit testing may present a potential high voltage electrical shock hazard. Test personnel should have appropriate PPE when approaching damaged batteries.
- 5.1.3 Test personnel shall use nonconductive or insulated tooling when working with the DUT.
- 5.1.4 Battery systems and test fixtures can be heavy and may require lifting. Removal after testing may pose additional difficulties (see Section 5.1.6).
- 5.1.5 Battery terminals should remain isolated until testing is ready to begin to avoid inadvertent shorting.
- 5.1.6 After testing has concluded, test articles may be damaged and pose a hazard during test cleanup. Stranded energy should be considered during post-test conditions and before battery disposal. Post-test isolation may also be compromised. Prior to handling conductive surfaces, the system shall be checked for isolation faults. Appropriate PPE might include Tyvek and respirators for post-test cleanup, depending on the facility requirements and battery chemistry. Post-test damaged terminals may not reliably indicate the total energy left in a battery. The testing agency should develop a plan for handling and disposing of damaged test articles.

## **5.2 Test Specific Precautions**

- 5.2.1 Short circuit testing may cause energetic reactions including toxic gas discharge, particulate generation, smoke and fire. Laboratories must be prepared to accommodate deleterious events associated with these procedures.
- 5.2.2 Testing equipment should be located in an area with isolating walls that can contain any flying debris and vents any gaseous discharge away from test personnel.
- 5.2.3 Criteria for the safe approach of a battery after short circuit testing should be considered before re-entry into the test area (e.g., allowing sufficient time for ventilation and temperature cooling).
- 5.2.4 Cleanup and disposal should follow industrial hygiene guidelines including proper PPE to be worn during this process.
- 5.2.5 A sparker shall not be used unless required by the specific test facility and/or a significant DUT vent occurs.

### 5.3 Safety Requirements

- 5.3.1 The testing agency must develop a specific safety plan for each short circuit test, including a list of required PPE. This safety plan should be based on information provided by the manufacturer regarding DUT chemistry and system architecture as well as precautions typically associated with high voltage systems. See discussion in Sections 5.1 and 5.2.

### 5.4 Test Facility/ Equipment Requirements

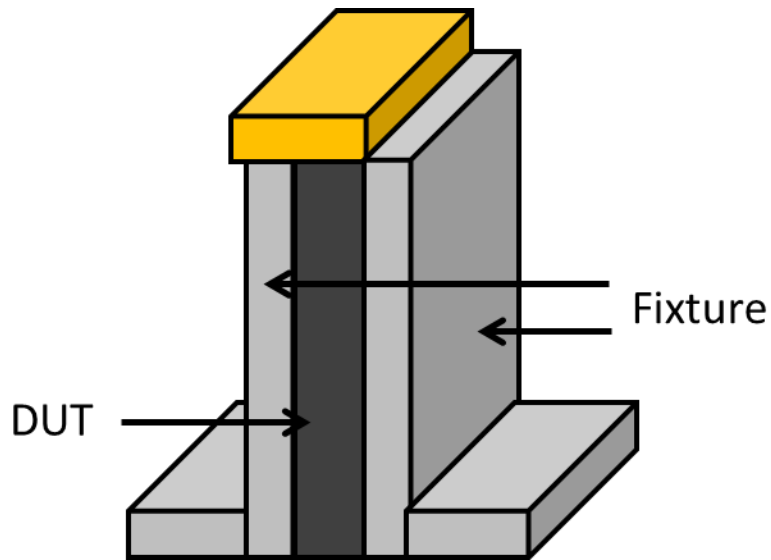
- 5.4.1 Facility and equipment requirements for short circuit testing:

- 5.4.1.1 The facility must have appropriate PPE such as respirators, safety glasses, and high voltage gloves. See discussion in Sections 5.1 and 5.2.
- 5.4.1.2 The facility must have a thermal chamber or temperature-controlled area for thermally soaking the DUT to a temperature of  $25\pm 3^{\circ}\text{C}$  (see Section 6.4).
- 5.4.1.3 The facility must have a battery tester that can supply the required constant current for discharge and charge steps. Tester requirements are DUT dependent and should be included in a device-specific test plan.
- 5.4.1.4 The facility must have current sense equipment capable of measuring the predicted current that will be delivered during an external short. Equipment requirements are DUT dependent and should be included in a device-specific test plan.
- 5.4.1.5 If necessary, the facility must be equipped with an appropriate fixture for holding test samples when conducting short circuit tests.

A fixture design example is shown in Figure 1, where the DUT is a single cell. The fixture consists of two plates that are secured in the appropriate orientation to hold the DUT during the short circuit test.

During a short circuit test, it is possible for a battery to generate significant internal gassing as a byproduct. This gassing will exert a pressure on the DUT casing and may also result in significant swelling. Thus, the addition of mechanical fixtures may also be necessary to prevent DUT swelling from interfering with the test.

- 5.4.1.6 The facility must also have the equipment necessary to safely introduce external short circuit resistances to the DUT. This should be specified in a device-specific test plan.



***Figure C-1 – Short circuit fixture example; the fixture plates and platen are shown in gray and the DUT is shown in dark gray with a gold bus bar.***

- 5.4.1.7 The facility must have temperature sensing capabilities. The thermocouple type shall be suitable for the given temperature range (e.g., type K). They shall be mounted to surfaces with pad type sensors and glued/bonded into place to resist dislocation under fire conditions.
- 5.4.1.8 The facility must have voltage and current sensors that are electrically isolated small gauge cables with mechanically secured sensing ends.
- 5.4.1.9 The facility must have an AC impedance meter capable of measuring the DUT at 1 kHz during rest conditions as specified.
- 5.4.1.10 The facility must have a data acquisition system (DAQ) for capturing measured parameters. See Section 6.3.2 for DAQ measurement rates.
- 5.4.1.11 The facility must have standard video recording equipment (at least two cameras for different perspectives).
- 5.4.1.12 The facility must have digital photography equipment.
- 5.4.1.13 The facility must be capable of proper disposal or recycling of damaged/burned DUTs or other byproducts of testing in compliance with environmental regulations.

## 5.5 Test Equipment Calibration

- 5.5.1 A written calibration procedure shall be provided that includes, at a minimum, the following information for all measurement and test equipment:
- Type of equipment, manufacturer, model number, etc.
  - Measurement range
  - Accuracy
  - Calibration interval
  - Type of standard used (calibration traceability of the standard must be evident)

## 6. TEST PROCEDURE

### 6.1 Test Type

- 6.1.1 The introduction of a short circuit is an abusive test that determines a DUT's reaction to electrical fault conditions.
- 6.1.2 Testing shall be conducted on full-sized RESSs. In preparation for full-scale testing, short circuit testing can also be conducted on single cells, cell strings, and modules to gauge the hazard severity levels with increasing battery size.

### 6.2 Device Under Test

- 6.2.1 The device under test (DUT) shall be a full-sized RESS. The test procedure, however, can also be applied to single cells, cell strings, and modules.
- 6.2.1.1 Single cells may be harvested from a spare RESS unit or may be provided separately by the RESS manufacturer or vehicle OEM.
- 6.2.1.2 Cell strings may be constructed from components harvested from a spare RESS unit, or may be provided separately by the RESS manufacturer or vehicle OEM.
- 6.2.1.3 Modules may be harvested from a RESS unit, or may be provided separately by the RESS manufacturer or vehicle OEM.

### 6.3 Test Guidelines

- 6.3.1 Various sensors shall be installed to collect information regarding the DUT's condition before, during, and after short circuit testing.
- 6.3.1.1 **Voltage** sensors are used to assess the battery SOC and general DUT condition. The number of voltage sensors depends on the DUT design. At a minimum, the overall DUT voltage shall be monitored. As appropriate, additional voltage sensors can be used to monitor sub-systems (e.g., cells, cell strings, modules, and/or bus bars within the DUT) to access more detailed information on the overall DUT SOC and condition.

- 6.3.1.2 **Current** sensors are required to monitor the discharge during testing as well as the post-test attempted discharge if the short circuit did not result in a EUCAR hazard severity level of 5 or more. Only one current channel per DUT is required for this test procedure. The test leads must be capable of delivering the targeted current based on the DUT specifications (a minimum of a 1C rate).
- 6.3.1.3 **Temperature** sensors are used to assess general DUT condition. The number of temperature sensors depends on the DUT design, size, and required level of information (as detailed in a device-specific test plan). At a minimum, temperature sensors should be placed in various locations external and, as appropriate, internal to the DUT.
- 6.3.2 Sensor requirements are summarized in Table 1. The specified data acquisition rates are the minimum requirements during the actual short circuit. The sampling rate may be reduced to 1 Hz when not under short circuit conditions. Note that the hard short circuit test (Section 6.6.2) requires a higher sampling rate than the medium and soft shorts (Sections 6.6.3 and 6.6.4).

***Table C-1 – Test Channel and Data Acquisition Requirements***

Variable	Units	Minimum Number of Test Channels	Minimum Data Acquisition Rate	
			Hard Short	Medium and Soft Shorts
Voltage	V	DUT Dependent	100 Hz	10 Hz
Current	A	1	100 Hz	10 Hz
Temperature	°C	DUT Dependent	100 Hz	10 Hz

- 6.3.3 For visual correlation of test events and data, two color video recordings with audio should be made. One recording shall be a wide view of the test area (e.g., chamber) and the other shall be a close-up of the test fixture and DUT. The test time shall be synched between video recordings and datalogs. A video file resolution of approximately 1920 x 1080 should be targeted.
- 6.3.4 Care should be taken to ensure that test leads attached to voltage, current and temperature sensors are isolated from each other such that they do not cause interference.

## 6.4 Test Parameters

- DUT beginning test temperature:  $25\pm 3^{\circ}\text{C}$
- Beginning SOC: 99 percent to 100 percent of the maximum normal operating SOC

## 6.5 DUT Preconditioning

- 6.5.1 Ensure that the DUT is at an ambient temperature of  $25\pm 3^{\circ}\text{C}$ . If not, allow the DUT to thermalize prior to testing.
- 6.5.2 Each DUT shall first be subjected to a controlled discharge/charge pattern. The voltage and current limits vary by DUT and should be provided by the manufacturer or a device-specific test plan.
- 6.5.2.1 **Discharge** at a 1C rate to the voltage corresponding to 0 percent SOC. Continue to sample appropriate test data (Section 6.3.2).
- 6.5.2.2 **Charge** at a 1C rate to the voltage corresponding to 100 percent SOC. Continue to sample appropriate test data (Section 6.3.2).
- 6.5.2.3 **Taper** charge to the voltage corresponding to 100 percent SOC until the current reaches a 0.05C rate. Continue to sample appropriate test data (Section 6.3.2).
- 6.5.3 Short circuit testing shall begin with the DUT at 100 percent SOC. Voltage and temperature data shall be recorded for a minimum of 2 minutes prior to the introduction of a short circuit. The DUT open circuit voltage shall be  $\pm 0.2\text{ V}$  from the voltage corresponding to 100 percent SOC during the initial 2 minute interval. If it is not, the discharge/charge profile in Section 6.5.2 shall be repeated.

## 6.6 Test Methodology

- 6.6.1 Prior to testing, conduct a pre-test inspection on the DUT.
- 6.6.1.1 Record the DUT open circuit voltage (V).
- 6.6.1.2 Record the DUT weight (kg).
- 6.6.1.3 Record the DUT dimensions; height, length, and width (mm).
- 6.6.1.4 Record the DUT AC impedance at 1 kHz ( $\Omega$ ).
- 6.6.1.5 Capture a minimum of four digital photos (one from each axis and one isometric).
- 6.6.2 Hard Short Circuit Test:
- 6.6.2.1 Secure the DUT in the test fixture.

- 6.6.2.2 Rest for 2 minutes and observe the open circuit voltage (see Section 6.5.3).
  - 6.6.2.3 Measure the DUT resistance at 100 percent SOC using a 1 kHz AC impedance meter.
  - 6.6.2.4 Determine the external short circuit resistance using the measured DUT resistance (Section 6.6.2.3) and a resistance ratio that is  $\leq 10$  (i.e., multiply the DUT resistance by a value that is  $\leq 10$ ; the exact ratio shall be provided in a device-specific test plan).
  - 6.6.2.5 Connect the external short circuit resistance and verify its value with a DC meter. Once the external short circuit is activated, it shall be applied for a minimum of 10 minutes.
  - 6.6.2.6 Observe and document the DUT response.
  - 6.6.2.7 End of hard short circuit testing is achieved when one of the following conditions are met:
    - The target time is achieved (i.e., 10 minutes), or
    - The DUT reaction results in a EUCAR hazard severity level  $\geq 5$  (with no applied spark).
- 6.6.3 Medium Short Circuit Test:
- 6.6.3.1 Secure the DUT in the test fixture.
  - 6.6.3.2 Rest for 2 minutes and observe the open circuit voltage (see Section 6.5.3).
  - 6.6.3.3 Measure the DUT resistance at 100 percent SOC using a 1 kHz AC impedance meter.
  - 6.6.3.4 Determine the external short circuit resistance using the measured DUT resistance (Section 6.6.3.3) and a resistance ratio that is 30 (i.e., multiply the DUT resistance by 30).
  - 6.6.3.5 Connect the external short circuit resistance and verify its value with a DC meter. Once the external short circuit is activated, it shall be applied for a minimum of 10 minutes.
  - 6.6.3.6 Observe and document the DUT response.

6.6.3.7 End of medium short circuit testing is achieved when one of the following conditions are met:

- The target time is achieved (i.e., 10 minutes), or
- The DUT reaction results in a EUCAR hazard severity level  $\geq 5$  (with no applied spark).

6.6.4 Soft Short Circuit Test:

6.6.4.1 Secure the DUT in the test fixture.

6.6.4.2 Rest for 2 minutes and observe the open circuit voltage (see Section 6.5.3).

6.6.4.3 Measure the DUT resistance at 100% SOC using a 1 kHz AC impedance meter.

6.6.4.4 Determine the external short circuit resistance using the measured DUT resistance (Section 6.6.4.3) and a resistance ratio that is 100 (i.e., multiply the DUT resistance by 100).

6.6.4.5 Connect the external short circuit resistance and verify its value with a DC meter. Once the external short circuit is activated, it shall be applied for a minimum of 2 hours.

6.6.4.6 Observe and document the DUT response.

6.6.4.7 End of soft short circuit testing is achieved when one of the following conditions are met:

- The target time is achieved (i.e., 2 hour), or
- The DUT reaction results in a EUCAR hazard severity level  $\geq 5$  (with no applied spark).

6.6.5 Once short circuit testing is completed, conduct a post-test inspection on the DUT.

6.6.5.1 Record the DUT open circuit voltage (V).

6.6.5.2 Record the DUT weight (kg).

6.6.5.3 Record the DUT dimensions; height, length, and width (mm).

6.6.5.4 Record the DUT AC impedance at 1 kHz ( $\Omega$ ).

6.6.5.5 Capture a minimum of four digital photos (one from each axis and one isometric).

## 6.7 Measured Data

6.7.1 Short circuit testing can yield a significant amount of data. A methodology to analyze the data and produce strategically relevant graphs is recommended for a test report.

6.7.2 DUT short circuit test reports should include the following information:



- Details on the DUT (size, chemistry, dimensions, etc.).
- Details from the receipt inspection (OCV, weight, AC impedance at 1 kHz, photos).
- Details of the short circuit test fixture.
- Video of the test from several angles, at least two.
- Details on timing (e.g., test start, time when test steps were initiated, etc.).
- Tabulated/plotted sensor data as determined from Section 6.7.1 (e.g., voltage, temperature, etc.).
- Tabulated/plotted derived parameters as determined from Section 6.7.1 (e.g., SOC, etc.).
- Details of the DUT response to short circuit testing (e.g., EUCAR hazard severity level).
- Details from the post-test inspection (OCV, weight, AC impedance at 1 kHz, photos).
- Note any test abnormalities, events, or deviations from the test procedure requirements.

## 6.8 Inspection Method

- 6.8.1 The post-test monitoring time is dependent on the DUT response to the introduction of a short circuit.
- 6.8.1.1 If the response results in a EUCAR hazard severity level of 2 or less, monitor the DUT for a minimum of 30 minutes.
- 6.8.1.2 If the response results in a EUCAR hazard severity level of 3 or 4, monitor the DUT for a minimum of 2 hours.
- 6.8.1.3 If the response results in a EUCAR hazard severity level of 5 or more, monitor the DUT for a minimum of 30 minutes.
- 6.8.2 After the specified monitoring period is over, determine if the change in temperature over time ( $dT/dt$ ) is  $\leq 0^{\circ}\text{C}/\text{min}$ . If a valid voltage signal is still present after the short circuit test, also determine if the change in voltage over time ( $dV/dt$ ) is  $\leq 1 \text{ mV}/\text{min}$ . If the DUT does not meet these criteria, repeat the specified monitoring time (see Section 6.8.1) and re-evaluate  $dT/dt$  and  $dV/dt$  again.
- 6.8.3 Once the  $dT/dt$  and  $dV/dt$  criteria are met, attempt a discharge to 0% SOC at a 1C rate. If that fails, apply a fixed load resistor to discharge the DUT. If this also fails, attempt one or more of the following methods (as appropriate) to remove any remaining stranded energy:

- Apply an external heat source to the DUT
- Mechanically crush of the DUT
- Immerse the DUT in a salt water bath

## 6.9 Post-Test Requirements

6.9.1 Care must be taken in handling tested samples because of possible residual charge, chemical or gaseous exposure or physical burns. The samples must be deemed in a safe condition (i.e., remaining energy removed, see Section 6.8.3) and then disposed in accordance with facility standards and governmental regulations for hazardous materials.

## 6.10 Acceptance Criteria

6.10.1 Tests should be monitored and their response categorized according to the EUCAR rating system adopted by in the 2005 FreedomCAR Manual of Test (see Table 2). This rating system appears in various battery test procedure and it is noted that the 2009 revision of SAE J2464 uses a modified rating system that shall not be used.

*Table C-2 – EUCAR Hazard Severity Levels*

Rating	Description	Classification Criteria and Effect
0	No Effect	No Effect. No loss of functionality.
1	Passive protection activated	No defect; no leakage; no venting, fire, or flame; no rupture; no explosion; no exothermic reaction or thermal runaway. Cell reversibly damaged. Repair of protection device needed.
2	Defect / Damage	No leakage; no venting, fire, or flame; no rupture; no explosion; no exothermic reaction or thermal runaway. Cell irreversibly damaged. Repair needed.
3	Leakage $\Delta$ mass < 50%	No venting, fire or flame*; no rupture; no explosion. Weight loss <50% of electrolyte weight (electrolyte = solvent + salt).
4	Venting $\Delta$ mass $\geq$ 50%	No fire or flame*; no rupture; no explosion. Weight loss of $\geq$ 50% of electrolyte weight (electrolyte= solvent + salt).
5	Fire or Flame	No rupture; no explosion (i.e., no flying parts).
6	Rupture	No explosion, but flying parts of the active mass.
7	Explosion	Explosion (i.e., disintegration of the cell).

## **Appendix D: Lessons Learned**

## **Ford Safety Performance of Rechargeable Energy Storage Systems**

### **Project Lessons Learned**

A retrospective assessment of the execution of the RESS project has resulted in team member observations that are considered Lessons Learned. These lessons are centered in the three aspects of project execution and management that include Technical, Planning, and Strategy and Financial Management. Each identified lesson learned is supported with the project team recommendations or proposals for future project teams that may be employed in further development of RESS systems assessments. Although some items may appear obvious to those with significant previous experience with this type of activity, and were understood by the Ford team prior to the project start, they are nevertheless included here as reference for potential future teams that may enter into this type of research with less background experience.

### **Technical**

**Data Acquisition Rates:** Given the importance of test data, the Test Site data acquisition rates and capabilities across all intended channels is likewise critical. The ability to correlate data and identify meaningful events during the test is made feasible with synchronized data. The lesson learned is that effort should be made to identify the desired data rates in the laboratory service quoting process and then verify the testing sources ability to meet those requirements during calibration or trial runs.

**Crush Test Ram Speed:** For uniformity and comparability of test results, the rate at which test samples are crushed is important. . The lesson learned is that effort should be made to identify the desired crush speed in the laboratory service quoting process and clearly identify actual machine capability (specifications) as well as verify the lab capability in calibration or trial runs.

**Data Files:** Generated data files, video in particular, can be of significant size. Because timely assessment of test results provides improved management of ongoing testing, the large files can present problems in this regard. In this project it was learned that the establishment of functional file sharing sites (eg., SharePoint) or FTP sites as well as the use of overnight mailing services for CDs, DVDs and/or hard drives is essential for incorporating the learnings from each test into subsequent test runs.

**Test Procedure Verification:** Electrical engineering understanding of test circuitry or test methods by test site personnel should not be automatically assumed. It was learned in this project that there must be an allowance in the startup of the laboratory for test-set-up debug time and method

verification. If required expertise is not resident in the test facility, external expert resources should be used. It is also important for the project lead to plan to participate in this test procedure explanation and pre-test debugging of the procedure to accommodate the specific equipment and personnel that are being used for testing.

**Test Sample Orientation:** During crush testing, the orientation of the test sample can impact the response of the test sample and the data generated. Care must be taken to specify the orientation of the sample relative to the interfaces for both the plane of the sample and the plane of the relevant test fixture, eg., 90 versus 180 degree crush ram orientation to the defined plane of the test sample. Detailed pictures are most beneficial.

**Laboratory Practices:** Good lab practices, such as maintaining clean test equipment and electrical connections, should be confirmed. It was learned that it is important to verify both the knowledge of the testing team concerning these important facets of test set-up and the practices to be followed during calibration or trial-runs and to ensure that equipment specifications are requested and reviewed in the test service quoting process.

**Procedure Specific Equipment:** It should not be assumed that an understanding of the fundamental characteristics of power supply, load bank, or cycling equipment is part of the skill set of all test site personnel. Such an understanding is important to the consistent and repeatable performance of testing and if not employed in all tests leads to compromised or even unusable data. The recommendation arising from this observation is that, where necessary, experts in the field of electrical testing must be involved in the selection or adaptation of test equipment when performing RESS tests. As previously observed, allowances for test-set-up debug time, method verification and on-site participation by project prime experienced personnel is essential.

**Battery Specific Technology:** It should not be assumed that an understanding of the fundamental characteristics of basic battery behavior is part of the skill set of all test site personnel. This element of the assessment process is essential for the ability to make immediate judgments on test events as a test progresses. It is essential that experienced personnel from the projects prime contractor be a part of initial and exploratory testing.

**Video Time Synchronization:** Video time synchronization is very important to provide a correct understanding of the timing of events. Synchronization can be challenging and should be verified in initial test start-ups. This is important to support making assessments that may provide indicators that critical events have taken place. Simple video cues such a lights or operational logic that can start multiple elements of test equipment are possible approaches to addressing this.

**Test Video Data Processing:** Video files of tests can be very large and handling on typical PC hardware can be very time consuming. In addition, conversion to/from CD/DVD data to Hard Drive or solid-state form adds significantly more time. Time lost to file preparation and transfer hinders the ability to make meaningful assessments of tests to allow for changes in parameters or

procedures that would improve subsequent test data. Large numbers of hardware interfaces (such as electrical connections, etc.) and their preparation can be challenging and optimal execution requires personnel who are knowledgeable with the specific interfaces to be used in the test lab.

**Test Support Capabilities:** Mechanical fabrication capabilities for test elements, such as sample specific fixtures, may not exist at test sites. The lack of fabrication ability may result in expected delays in testing or inconsistent test execution. The lesson learned is that strict specifications for mechanical fixtures to be used during testing, including tolerances and exact configurations must be provided and verified before testing.

**Video Equipment Robustness:** During the course of abuse testing, hardware responses may lead to damage of video test equipment. For this type of laboratory testing in confined spaces, attention must be paid to include shielding where possible, and consider the effect of vent products obscuring camera views. Consider usage of a standardized video camera across multiple tests and test sites. Ensure both wide and narrow camera view, and consider high zoom levels to protect camera with distance where possible.

## Planning and Strategy

**Test Program Planning:** The total duration, from set-up to finish, for a single test should be comprehended and considered in relation to typical shift lengths and efficiency of execution. Unexpected issues at individual test sites can result in significant project timing delays. The lesson learned in this project is that for volume testing, there should be a plan for testing at back-up sites, and this plan should be in place prior to start of any testing.

**Test Site Management:** Each test site/organization in North America for abuse testing has strengths and weaknesses. It must be an element of planning to have on-site availability of project prime's personnel at individual test sites prior to and at start of testing, as well as occasionally throughout testing. In addition, logistics, methods, and timing for post-test data exchange can be a significant amount of work and should be considered as a critical issue. The lesson learned in this project is that this interaction is critical and that the project team should set clear expectations before the project start.

**Data analysis:** Data analysis, filtering, and interpretation can be significant labor items. Interrogating large data files, integrating data, photographs and video information requires significant work. The lesson learned from this effort is that dedicated teams for this work should be set in advance, and analytical approaches and methods should be formally developed and shared between team members.

**Test Sample Acquisition:** Sourcing relevant test hardware may present challenges. Issues related to use restrictions, confidentiality concerns and preparation of hardware can require much time and effort before material is available and ready for testing. In this project it was learned

that obtaining useful test material, team personnel with significant industry contacts and experience must be involved.

## **Financial**

**Scope of Work:** Project scope of works for individual test sites should be well-finalized and consciously agreed-to by all stakeholders before start of actual testing. Although it may not be feasible to plan for every contingency in the initial plan, a well-reviewed scope of work that is then reviewed and confirmed by the test site must be used for financial administration and it must be retained as a living document throughout project. The lesson learned is that tests sites must address all details in the scope of work to both understand their true cost of performance and manage to that cost plan.

**Detail Cost Assumptions:** The costs of testing and quality of output have at least a partially inverse relationship. At the outset, quote as widely as possible; require equipment specifications response in quotes. The project prime must plan for in-person test site visits prior to sourcing.

**Test Cost Planning:** Additional hardware and cost for initial set-up and prove-out can be a significant part of the overall project and allowances for both should be included in the project budget. These should be discussed with testing sources.

**Invoicing and Payment:** Invoice and payment timing of organizations can be significantly different, as can contracting complexity. In order to communicate and coordinate the necessary interactions between project team organizations, tracking and scheduling should be done by dedicated personnel with expectations communicated before start of the project. One or more project personnel who have access to and cognizance of all project documentation and communication should be identified. Clarification of communication contacts among all organizations is important.

DOT HS 812 756  
July 2019



U.S. Department  
of Transportation  
**National Highway  
Traffic Safety  
Administration**

